



User Manual for the  
*HE693STG884 and*  
*HE693STG884-25*

# High Resolution Strain Gauge Module

Eighth Edition,  
17 November 1999

**MAN0083-08**



## PREFACE

This manual explains how to use the Horner APG's High Resolution Strain Gauge Module.

Copyright (C) 1999 Horner APG, LLC., 640 North Sherman Drive, Indianapolis, Indiana 46201. All rights reserved. No part of this publication may be reproduced, transmitted, transcribed, stored in a retrieval system, or translated into any language or computer language, in any form by any means, electronic, mechanical, magnetic, optical, chemical, manual or otherwise, without the prior agreement and written permission of Horner APG, LLC.

All software described in this document or media is also copyrighted material subject to the terms and conditions of the Horner Software License Agreement.

Information in this document is subject to change without notice and does not represent a commitment on the part of Horner APG, LLC.

Logicmaster is a trademark of GE Fanuc.

***For user manual updates, contact Horner APG, Technical Support Division, at (317) 916-4274 or visit our website at [www.heapg.com](http://www.heapg.com).***

## LIMITED WARRANTY AND LIMITATION OF LIABILITY

Horner APG, LLC., ("HE-APG") warrants to the original purchaser that the High Resolution Strain Gauge Module manufactured by HE-APG is free from defects in material and workmanship under normal use and service. The obligation of HE-APG under this warranty shall be limited to the repair or exchange of any part or parts which may prove defective under normal use and service within two (2) years from the date of manufacture or eighteen (18) months from the date of installation by the original purchaser whichever occurs first, such defect to be disclosed to the satisfaction of HE-APG after examination by HE-APG of the allegedly defective part or parts. THIS WARRANTY IS EXPRESSLY IN LIEU OF ALL OTHER WARRANTIES EXPRESSED OR IMPLIED INCLUDING THE WARRANTIES OF MERCHANTABILITY AND FITNESS FOR USE AND OF ALL OTHER OBLIGATIONS OR LIABILITIES AND HE-APG NEITHER ASSUMES, NOR AUTHORIZES ANY OTHER PERSON TO ASSUME FOR HE-APG, ANY OTHER LIABILITY IN CONNECTION WITH THE SALE OF THIS HIGH RESOLUTION STRAIN GAUGE MODULE. THIS WARRANTY SHALL NOT APPLY TO THIS HIGH RESOLUTION STRAIN GAUGE MODULE OR ANY PART THEREOF WHICH HAS BEEN SUBJECT TO ACCIDENT, NEGLIGENCE, ALTERATION, ABUSE, OR MISUSE. HE-APG MAKES NO WARRANTY WHATSOEVER IN RESPECT TO ACCESSORIES OR PARTS NOT SUPPLIED BY HE-APG. THE TERM "ORIGINAL PURCHASER", AS USED IN THIS WARRANTY, SHALL BE DEEMED TO MEAN THAT PERSON FOR WHOM THE HIGH RESOLUTION STRAIN GAUGE MODULE IS ORIGINALLY INSTALLED. THIS WARRANTY SHALL APPLY ONLY WITHIN THE BOUNDARIES OF THE CONTINENTAL UNITED STATES.

In no event, whether as a result of breach of contract, warranty, tort (including negligence) or otherwise, shall HE-APG or its suppliers be liable of any special, consequential, incidental or penal damages including, but not limited to, loss of profit or revenues, loss of use of the products or any associated equipment, damage to associated equipment, cost of capital, cost of substitute products, facilities, services or replacement power, down time costs, or claims of original purchaser's customers for such damages.

**To obtain warranty service, return the product to your distributor with a description of the problem, proof of purchase, post paid, insured and in a suitable package.**

## ABOUT PROGRAMMING EXAMPLES

Any example programs and program segments in this manual or provided on accompanying diskettes are included solely for illustrative purposes. Due to the many variables and requirements associated with any particular installation, Horner APG cannot assume responsibility or liability for actual use based on the examples and diagrams. It is the sole responsibility of the system designer utilizing HIGH RESOLUTION STRAIN GAUGE MODULE to appropriately design the end system, to appropriately integrate the HIGH RESOLUTION STRAIN GAUGE MODULE and to make safety provisions for the end equipment as is usual and customary in industrial applications as defined in any codes or standards which apply.

**Note: The programming examples shown in this manual are for illustrative purposes only. Proper machine operation is the sole responsibility of the system integrator.**

## TABLE OF CONTENTS

PREFACE.....	3
LIMITED WARRANTY AND LIMITATION OF LIABILITY .....	4
ABOUT PROGRAMMING EXAMPLES.....	4
TABLE OF CONTENTS.....	5
CHAPTER 1: INTRODUCTION.....	7
1.1 Product Description.....	7
CHAPTER 2: CONFIGURATION .....	9
2.1 General.....	9
2.2 Configuration Procedures .....	9
2.3 Configuration Parameters .....	11
2.4 Digital Filtering.....	12
CHAPTER 3: WIRING & INSTALLATION.....	13
3.1 Wiring Diagram for the STG884 / STG884-25 Terminal Block Connection.....	13
3.2 Installation Hints .....	13
CHAPTER 4: INPUT SCALING.....	15
4.1 Normal input scaling.....	15
4.2 Excitation Compensation .....	15
CHAPTER 5: ALARMS, SETPOINTS AND WEIGHING FUNCTIONS.....	17
5.1 General .....	17
5.2 Alarms and Setpoints.....	18

## Revisions to this Manual

The following changes have been made to this manual (MAN0083-08):

1. Revised Section 1.1 by adding a new module (HE693STG884-25).
2. Revised Section 5.1 to indicate that when using the standard unit (STG884), Zero and Tare values are preserved when the unit is powered down. When using the STG884-25 Option, Zero and Tare values are cleared at power-up.

**THIS PAGE INTENTIONALLY LEFT BLANK**

# CHAPTER 1: INTRODUCTION

## 1.1 Product Description

The High Resolution Strain Gauge Input Module (HE693STG884 / HE693STG884-25) allows bridged strain gauges (load cells) to be directly connected to a PLC without external signal processing (e.g., transducers, transmitters). All analog and digital processing of the signal is performed on the module, and precision millivolt values are written to the Series 90-30 %AI input table with 16 bit resolution. The input range of the module is +/-25mV, +/-50mV or +/-100mV, and it is configurable through Logicmaster on a channel-by-channel basis. This provides a resolution of approximately 0.8uV, 1.6uV, or 3.2uV, respectively. Also, individual channels can be turned off so that unused channels do not increase module response time.

Another ability of the High Resolution Strain Gauge Input Module (STG884 / STG884-25) is to monitor the load cell excitation voltage, and compensate for variations in the signal. **Excitation voltage output is not supplied by the module.** The STG884 / STG884-25 also features a setpoint for each channel and is set with %AQ values and enunciated with %I inputs. Outputs (%Q) allow the ladder logic to trigger the module to perform a ZERO, TARE, or CLEAR function, critical for weighing applications.

When using the standard unit (STG884), Zero and Tare values are preserved when the unit is powered down. When using the STG884-25 Option, Zero and Tare values are cleared at power-up.

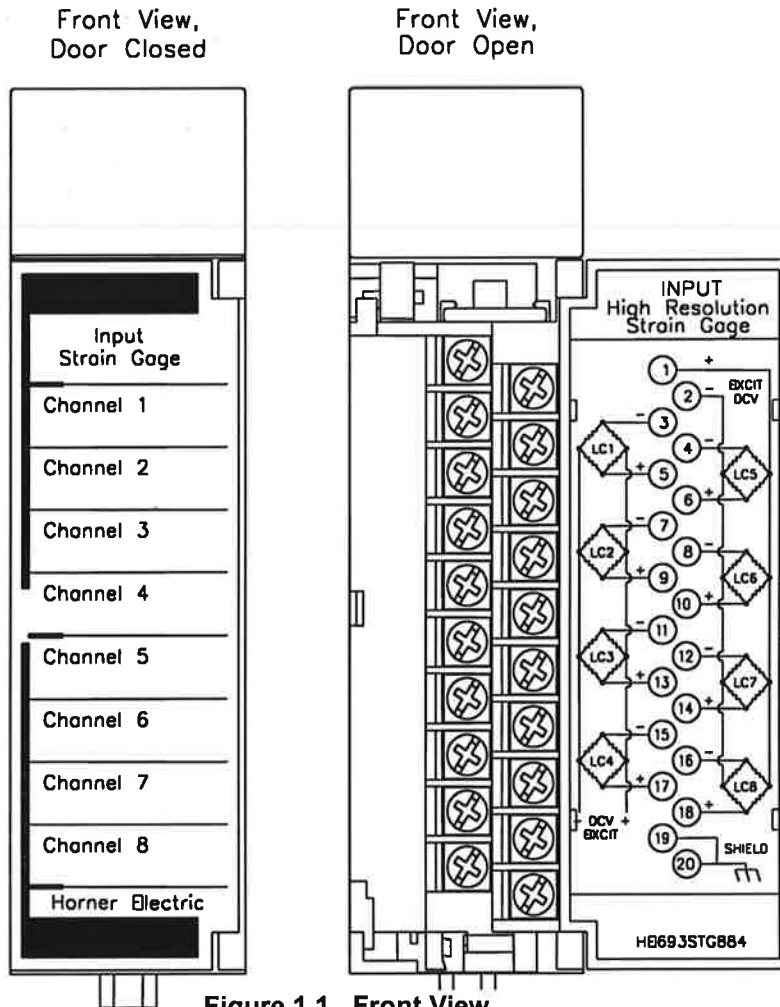

Side View

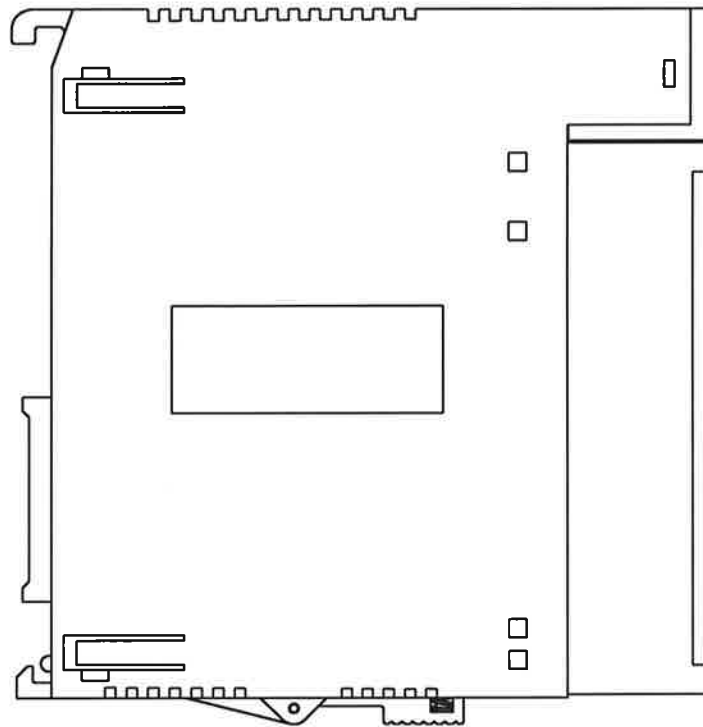

STG884.DWG

Figure 1.2 – Side View

Power Consumption	Inrush: 160mA @ 5VDC 80mA @ 24V Relay	Input Impedance	>1000M ohms
	Steady State: 30mA @ 5VDC 25mA @ 24V Relay	Accuracy	.03%
Number of Channels	8	Maximum Normal Voltage Input	100mV
I/O Points Required	8-%AI, 16-%I, 8-%AQ, 16-%Q	Maximum Safe Voltage	+/- 35VDC or AC
Strain Gauge Supported	Bridged (Load Cells)	A/D Conversion Type	Integrating
Input Range	+/- 25mV, +/- 50mV, +/- 100mV	A/D Conversion Time	35 Channel per Second
Resolution	.8uV, 1.6uV, 3.2uV, respectfully	Operating Temperature	0 to 60°C (32 to 140°F)
Excitation Monitoring	10VDC	Relative Humidity	5% to 95% non-condensing



## CHAPTER 2: CONFIGURATION

### 2.1 General

Chapter Two describes the procedures and set-up for I/O configuration using LogicMaster™ software.

### 2.2 Configuration Procedures

1. Upon entering the LogicMaster™ 90 software, select 'LogicMaster Configuration Package' by pressing the F2 key.

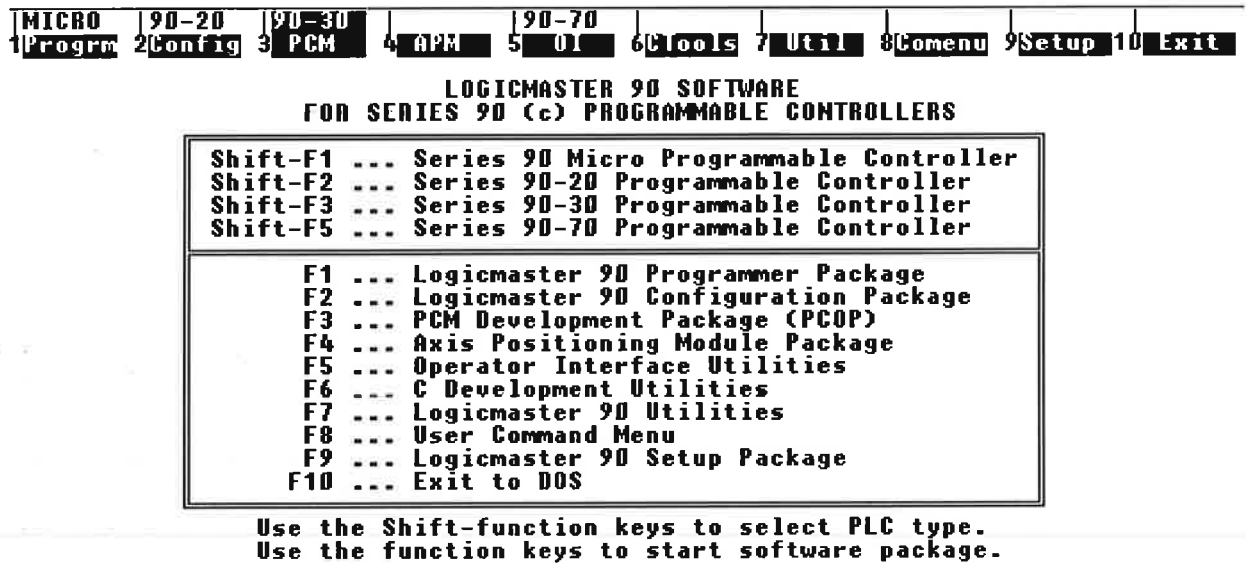

Figure 2.1 – Default Screen

2. To reach the configuration screen, select 'I/O Configuration' (F1), from the menu

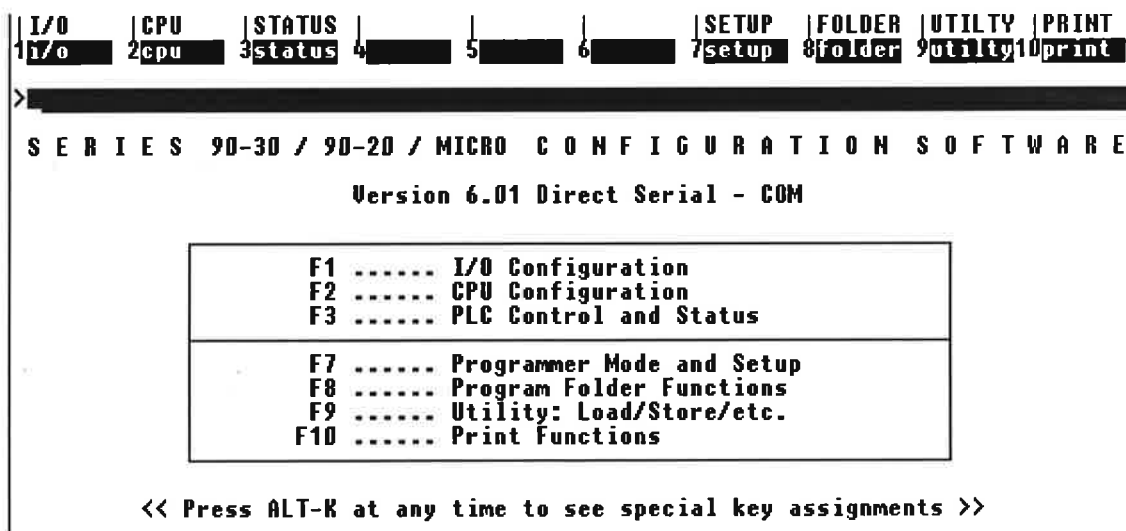

Figure 2.2 – Configuration Screen

- 3. Move cursor to the designated slot containing the module and select 'Other' (F8) .

```
|RACK| COPY | REF UU | DELETE | UNDEL | | | | | | | |
| m30 io | 2genius | 3 | 4ps | 5rcksel | 6comm | 7 | 8other | 9 | 10zoom |
>
```

PS/CPU	1	2	3	4	5
	PROGRAMMED CONFIGURATION				
PWR321					
CPU 30					

Figure 2.3 – Rack Configuration

- 4. From the following screen, select 'Foreign' (F3) .

```
|RACK| | | | | | | | | | |
| pcm | 2hsc | 3frgn | 4oi | 5apm | 6iolink | 7iop | 8 | 9 | 10 |
>
SERIES 90-30 MODULE IN RACK U SLOT 5
SOFTWARE CONFIGURATION
SLOT 5 Catalog #:

```

Figure 2.4 – Slot Configuration

5. The screen (shown in Figure 2.5) appears:

SOFTWARE CONFIGURATION	
<b>SLOT 2</b>	Catalog #: FOREIGN FOREIGN MODULE
<b>FRGN</b>	Module ID : 3 %I Ref Adr : %I0001 Byte 1 : 00000001 Byte 9 : 00 %I Size : 16 Byte 2 : 00000100 Byte 10 : 00 %Q Ref Adr : %Q0001 Byte 3 : 00 Byte 11 : 00 %Q Size : 16 Byte 4 : 00 Byte 12 : 00 %AI Ref Adr : %AI001 Byte 5 : 00 Byte 13 : 00 %AI Size : 8 Byte 6 : 00 Byte 14 : 00 %AQ Ref Adr : %AQ001 Byte 7 : 00 Byte 15 : 00 %AQ Size : 8 Byte 8 : 00 Byte 16 : 00

Figure 2.5 Module Configuration

2.3 Configuration Parameters

Table 2.1 shows the necessary parameters for configuring the STG884 / STG884-25. These parameters are %AI Size, %I Size, %AQ Size, %Q Size, Byte1, Byte 2 (digital filtering), and Bytes 3-10 (input range).

%AI	%I	%AQ	%Q	Byte 1	Byte 2
8	16	8	16	1	0 to 111 binary (see figure 2.6)

Table 2.2 shows the input range for each channel. This range is configured through Bytes 3-10. Byte 3 sets channel 1, Byte 4 sets channel 2, etc. Excitation compensation is also set through these configuration parameters.

Input Range (+/-)	25mV	50mV	100mV	25mV	50mV	100mV	Off
Excitation comp?	N	N	N	Y	Y	Y	N
Byte 3 – 10 Value	0	1	2	3	4	5	6

## 2.4 Digital Filtering

Figure 2.6 shows the effect of digital filtering (set by Byte 2) on the module response to a milli-volt input change (% temp change vs. time). The response time is improved by 12.5% for each unused channel turned off with bytes 3-10 in the configuration. In an environment where noise is a factor. A high filter number needs to be used to insure an accurate reading from the STG884 / STG884-25.

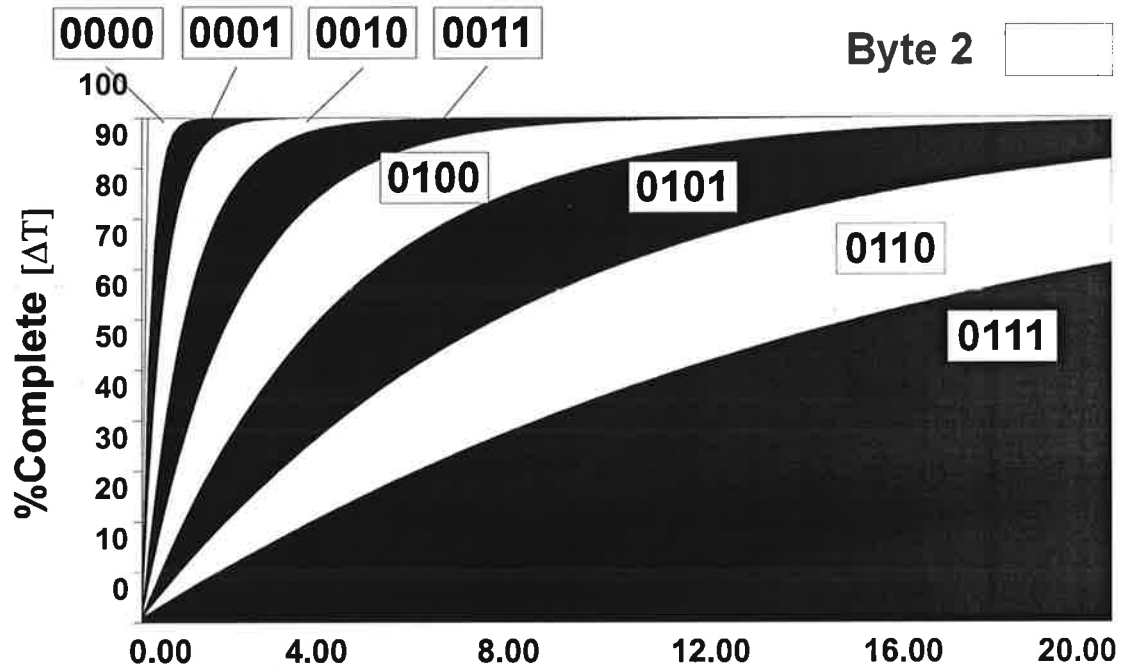

Figure 2.6 - The Effects of Digital Filtering

## CHAPTER 3: WIRING & INSTALLATION

### 3.1 Wiring Diagram for the STG884 / STG884-25 Terminal Block Connection

Note: The following diagram covers both the STG884 and the STG884-25.

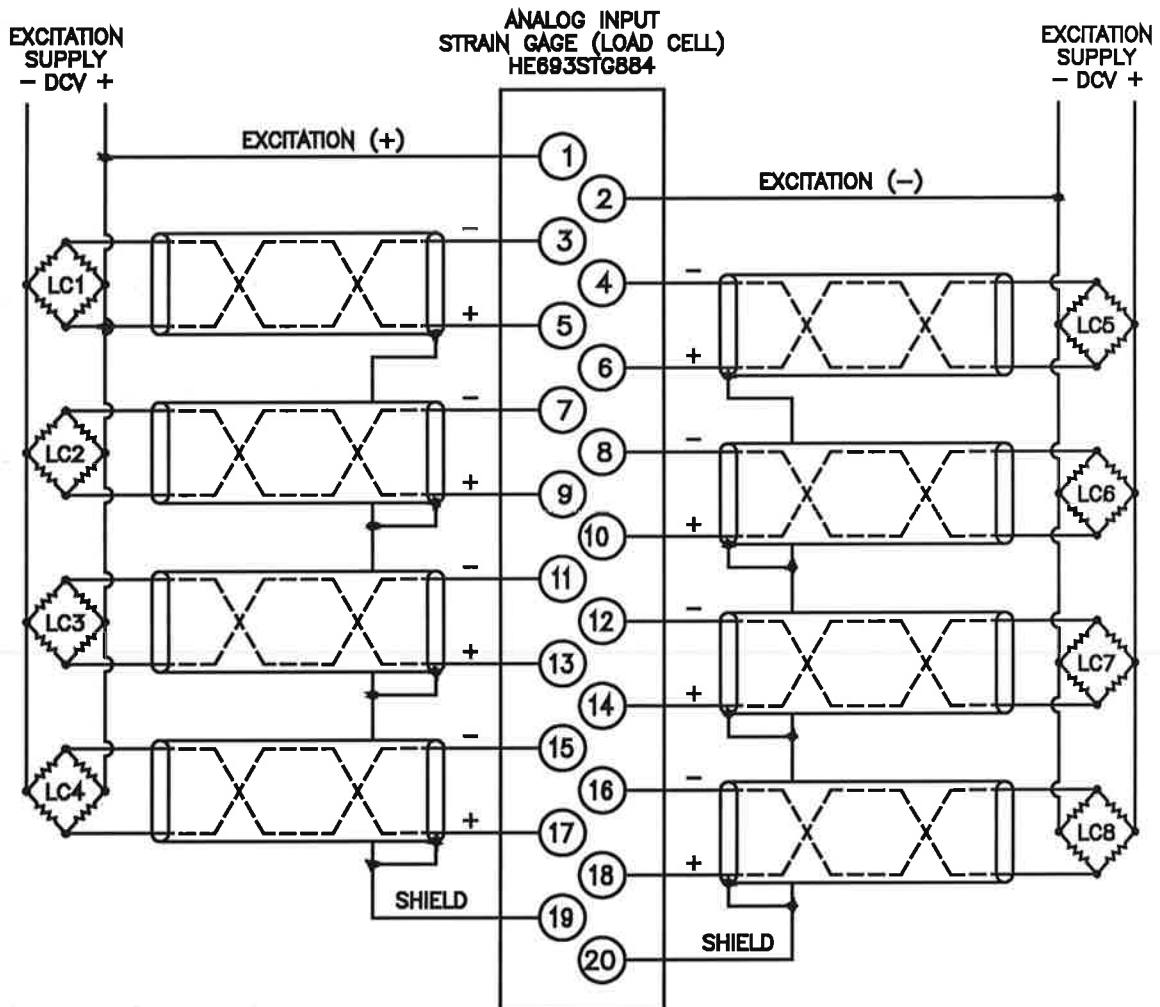

Figure 3.1 – Wiring Diagram

### 3.2 Installation Hints

- Keep total wire resistance less than 100 ohms to maintain rated accuracy.
- Wiring should be routed in its own conduit. Shielded, twisted pair wiring offers best noise immunity.
- If shielded wiring is used, a good earth ground connection is critical. If shields are connected at the module end, terminals 19 and 20 may be used as the shield ground.
- All unused inputs should be shorted and connected to pin 19 or 20.

NOTES

## CHAPTER 4: INPUT SCALING

### 4.1 Normal input scaling

Figure 4.1 shows the value of each %AI input varies from  $-32,000$  to  $32,000$ , as the milli-volt input ranges from minus full scale(-FS) to positive full scale(+FS). Full scale is either 25mV, 50mV, or 100mV, as configured by the system designer on a channel by channel basis.

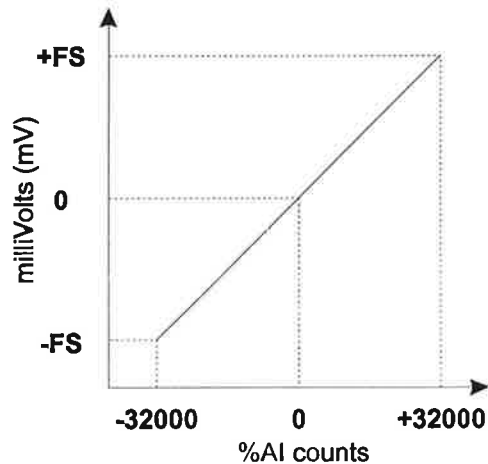

Figure 4.1 Input Scaling

### 4.2 Excitation Compensation

Figure 4.2 illustrates how the Excitation voltage plays a role on the STG884 / STG884-25. If the excitation voltage varies from its calibrated value, the module automatically adjusts the %AI value in the PLC to compensate for the voltage variation. This function may be selected on a channel-by-channel basis in Logicmaster™ through bytes 3-10 of the configuration parameters.

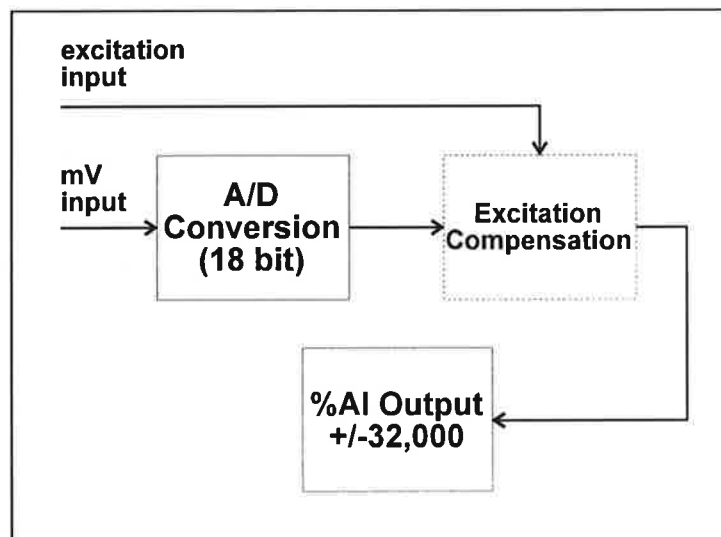

Figure 4.2 Excitation Compensation

NOTES



## CHAPTER 5: ALARMS, SETPOINTS AND WEIGHING FUNCTIONS

### 5.1 General

Figure 5.1 below demonstrates the weighing functions which can be performed by the Strain Gauge input module. A small amount of residue causes an empty scale to read a non-zero value. Performing the **ZERO** function causes the module to set the input value (%AI) to 0. An empty container is now placed on the scale. The value in the %AI register now reflects the weight of the empty container. Performing a **TARE** function causes the module to store the weight of the container in its internal memory, and set the %AI register to 0. Material is poured into the container. The %AI value now reflects the weight of this material only. Performing a **CLEAR** function causes the module to add the weight of the container stored in its internal memory back to %AI register. The %AI reading now reflects the total weight of the material plus the container.

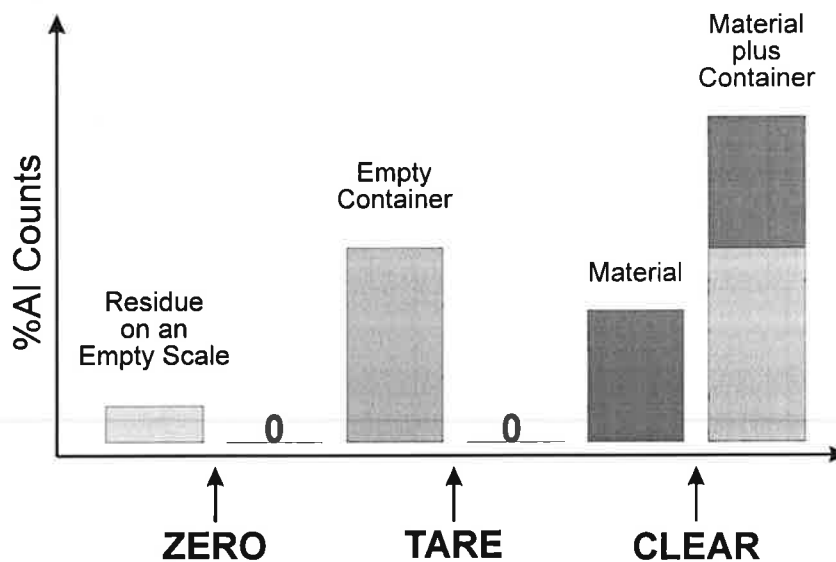

Figure 5.1 Weighing Function

When setting the Zero, Tare, and Clear functions as shown in the bit pattern in Table 5.1. The Output bit number (%Q) must be reset between the execution of Zero to Tare or Tare to Clear. This allows for the proper measurements to occur at each function.

Channel # (%AI)	1		2		3		4		5		6		7		8	
Output Bit # (%Q)	1	2	3	4	5	6	7	8	9	10	11	12	13	14	15	16
<b>ZERO</b>	1	1	1	1	1	1	1	1	1	1	1	1	1	1	1	1
<b>TARE</b>	1	0	1	0	1	0	1	0	1	0	1	0	1	0	1	0
<b>CLEAR</b>	0	1	0	1	0	1	0	1	0	1	0	1	0	1	0	1

When using the standard unit (STG884), Zero and Tare values are preserved when the unit is powered down. When using the STG884-25 Option, Zero and Tare values are cleared at power-up.

## 5.2 Alarms and Setpoints

In addition to the weight functions triggered by the %Q output bits, the Strain Gauge input module's I/O interface performs other functions as well. The input value read by each channel is written to %AI input registers, which are scaled as shown by table 5.2. Each channel can have a setpoint, which is set by writing a decimal value to the appropriate %AQ register. If the input value for the channel exceeds its setpoint, the "Setpoint Alarm" bit (%I) for that channel is energized. If the input value reaches the normal 32,767 count maximum, and "Overrange Alarm" bit (%I) is energized for that channel.

I/O Function	Channel Number							
	1	2	3	4	5	6	7	8
<b>Input Value (%AI)</b>	%AI1	%AI2	%AI3	%AI4	%AI5	%AI6	%AI7	%AI8
<b>Setpoint (%AQ)</b>	%AQ1	%AQ2	%AQ3	%AQ4	%AQ5	%AQ6	%AQ7	%AQ8
<b>Overrange Bit Number (%I)</b>	%I1	%I2	%I3	%I4	%I5	%I6	%I7	%I8
<b>SetPoint Exceeded Bit (%I)</b>	%I9	%I10	%I11	%I12	%I13	%I14	%I15	%I16