



User Manual for the
HE693OIU150, HE693OIU152,
HE693OIU175,

Operator Interfaces

Second Edition
June 1993

MAN0067-02

PREFACE

This manual explains how to use the Horner Electric Operator Interface Unit for use with the GE Fanuc Series 90 family of Programmable Logic Controllers.

Copyright (C) 1990, 1991 Horner Electric, Inc., 1521 East Washington Street, Indianapolis Indiana 46201-3899. All rights reserved. No part of this publication may be reproduced, transmitted, transcribed, stored in a retrieval system, or translated into any language or computer language, in any form by any means, electronic, mechanical, magnetic, optical, chemical, manual or otherwise, without the prior agreement and written permission of Horner Electric, Inc.

Information in this document is subject to change without notice and does not represent a commitment on the part of Horner Electric, Inc.

Series 90 and Logicmaster are trademarks of GE Fanuc Automation North America Inc.

LIMITED WARRANTY AND LIMITATION OF LIABILITY

Horner Electric, Inc. ("HE") warrants to the original purchaser that the Operator Interface Unit manufactured by HE is free from defects in material and workmanship under normal use and service. The obligation of HE under this warranty shall be limited to the repair or exchange of any part or parts which may prove defective under normal use and service within two (2) years from the date of manufacture or eighteen (18) months from the date of installation by the original purchaser whichever occurs first, such defect to be disclosed to the satisfaction of HE after examination by HE of the allegedly defective part or parts. THIS WARRANTY IS EXPRESSLY IN LIEU OF ALL OTHER WARRANTIES EXPRESSED OR IMPLIED INCLUDING THE WARRANTIES OF MERCHANTABILITY AND FITNESS FOR USE AND OF ALL OTHER OBLIGATIONS OR LIABILITIES AND HE NEITHER ASSUMES, NOR AUTHORIZES ANY OTHER PERSON TO ASSUME FOR HE, ANY OTHER LIABILITY IN CONNECTION WITH THE SALE OF THIS OPERATOR INTERFACE UNIT. THIS WARRANTY SHALL NOT APPLY TO THIS OPERATOR INTERFACE UNIT OR ANY PART THEREOF WHICH HAS BEEN SUBJECT TO ACCIDENT, NEGLIGENCE, ALTERATION, ABUSE, OR MISUSE. HE MAKES NO WARRANTY WHATSOEVER IN RESPECT TO ACCESSORIES OR PARTS NOT SUPPLIED BY HE. THE TERM "ORIGINAL PURCHASER", AS USED IN THIS WARRANTY, SHALL BE DEEMED TO MEAN THAT PERSON FOR WHOM THE OPERATOR INTERFACE UNIT IS ORIGINALLY INSTALLED. THIS WARRANTY SHALL APPLY ONLY WITHIN THE BOUNDARIES OF THE CONTINENTAL UNITED STATES.

In no event, whether as a result of breach of contract, warranty, tort (including negligence) or otherwise, shall HE or its suppliers be liable of any special, consequential, incidental or penal damages including, but not limited to, loss of profit or revenues, loss of use of the products or any associated equipment, damage to associated equipment, cost of capital, cost of substitute products, facilities, services or replacement power, down time costs, or claims of original purchaser's customers for such damages.

To obtain warranty service, return the product to your distributor with a description of the problem, proof of purchase, post paid, insured and in a suitable package.

ABOUT THE PROGRAM EXAMPLES

The example programs and program segments in this manual are included solely for illustrative purposes. Due to the many variables and requirements associated with any particular installation, Horner Electric cannot assume responsibility or liability for actual use based on the examples and diagrams. It is the sole responsibility of the system designer utilizing the Operator Interface Unit to appropriately design the end system, to appropriately integrate the Operator Interface Unit and to make safety provisions for the end equipment as is usual and customary in industrial applications as defined in any codes or standards which apply.

TABLE OF CONTENTS

CHAPTER 1: INTRODUCTION

1.1	What You Have	Page 1-1
1.2	Operator Interface Unit Features	Page 1-1
1.3	Hardware Description	Page 1-2
1.4	Specifications	Page 1-2

CHAPTER 2: INSTALLATION

2.1	Mounting Requirements	Page 2-1
2.2	Power Requirements	Page 2-1
2.3	Communications Cable	Page 2-2
2.4	Series 90 CPU Configuration	Page 2-2

CHAPTER 3: INITIAL OPERATION

3.1	Running the Self Test	Page 3-1
3.2	Operating Modes	Page 3-3
3.3	Set-up Mode	Page 3-3
3.4	Autorun Mode	Page 3-3

CHAPTER 4: THE MAIN MENU

4.1	RS485 Set-up	Page 4-2
4.1.1	Baud Rate Selection	Page 4-3
4.1.2	Parity Type Selection	Page 4-3
4.1.3	Data Bit Selection	Page 4-3
4.1.4	Stop Bit Selection	Page 4-3
4.1.5.	Returning to the Main Menu	Page 4-3
4.2	RS232 Set-up	Page 4-4
4.2.1	Baud Rate Selection	Page 4-5
4.2.2	Parity Type Selection	Page 4-5
4.2.3	Data Bit Selection	Page 4-5
4.2.4	Stop Bit Selection	Page 4-5
4.2.5.	Returning to the Main Menu	Page 4-5

4.3	PLC Data Access	Page 4-6
4.3.1	Data Type Selection.	Page 4-6
4.3.2	PLC Data Monitoring	Page 4-7
4.3.3	Reading Decimal Data	Page 4-8
4.3.4	Reading Hexadecimal Data	Page 4-8
4.3.5	Reading Binary Data	Page 4-9
4.3.6	Reading On/Off Data	Page 4-9
4.4	Changing PLC Data	Page 4-9
4.4.1	Writing Decimal Data	Page 4-9
4.4.2	Writing Hexadecimal Data	Page 4-10
4.4.3	Writing Binary Data	Page 4-11
4.4.4	Writing On/Off Data	Page 4-11
4.5	Customization	Page 4-11
4.6	Setting the Clock	Page 4-11
4.6.1	Setting the Time and Date	Page 4-11
4.6.2	Selecting the PLC Time and Date Registers	Page 4-12
4.6.3	Selecting the Time and Date Update Interval	Page 4-12
4.7	The Self Test	Page 4-12

CHAPTER 5: THE CUSTOMIZATION MENU

5.1	Setting the Password	Page 5-1
5.2	Defining a Custom Display	Page 5-2
5.2.1	Selecting the Display Number	Page 5-2
5.2.2	Using the Function Key Customization Insert	Page 5-3
5.2.3	Defining the Display Text	Page 5-3
5.2.4	Defining PLC Data Display Fields	Page 5-8
5.2.5	Selecting the PLC Data Items	Page 5-10
5.2.6	Copying Screens	Page 5-10

5.3	Setting the Trigger Register	Page 5-10
5.3.1	Triggering Screen Changes	Page 5-11
5.3.2	Triggering Output to the Printer Port	Page 5-11
5.3.3	Determining the Current Screen Number.	Page 5-12
5.4	Entering AUTORUN Mode	Page 5-12
5.5	Adjusting the Display Contrast	Page 5-12
5.6	Defining Function Keys	Page 5-13
5.6.1	Special Keys	Page 5-13
5.6.2	Function Key Example	Page 5-14
5.7	High User Screen Number	Page 5-15

CHAPTER 6: AUTORUN MODE

6.1	Changing "Screens".	Page 6-1
6.2	Monitoring PLC Data	Page 6-1
6.3	Changing PLC Data.	Page 6-1
6.4	Exiting AUTORUN Mode	Page 6-3

CHAPTER 7: TROUBLESHOOTING

7.1	Nothing on the LCD Display	Page 7-1
7.2	No Communications.	Page 7-1

APPENDIX A:	CABLE INFORMATION	Page A-1
APPENDIX B:	PANEL CUTOUT	Page B-1
APPENDIX C:	FACTORY CUSTOMIZATION	Page C-1
APPENDIX D:	OIU152 / 175 SUPPLEMENT	Page D-1
APPENDIX E:	MEMORY STORAGE	Page E-1

CHAPTER 1: INTRODUCTION

Congratulations on your purchase of the Horner Electric Operator Interface Unit! This module has been designed using state-of-the-art electronic components and incorporates a sophisticated firmware package that gives the Original Equipment Manufacturer (OEM) the ability to customize the module for virtually any application.

1.1 What You Have

The Horner Electric Operator Interface Unit (OIU) comes complete with the following items;

- A. Assembled OIU module and mounting hardware,
- B. (Optional) Back panel shroud,
- C. (Optional) Six foot cable assembly for connection to a Series 90 PLC,
- D. (Optional) Host Programming Package with diskette and programming cable.
- E. This manual.

1.2 Operator Interface Unit Features

The Horner Electric Operator Interface Unit provides the following features:

- A. Backlit, 2 line by 16 character dot-matrix alphanumeric LCD display on the OIU150/152. Backlit, 2 line by 20 character dot-matrix alphanumeric Vacuum Fluorescent display on the OIU175.
- B. 32 position metal dome tactile feel keypad with full numeric support.
- C. 12 function keys with 24 user-definable functions.
- D. SNP (Series 90) communications port, using 15-pin RS485 interface.
- E. Programming/printer port, using 9-pin RS232 interface.
- F. Gasketed NEMA 4-12 panel with overlay, mounting hardware is included.
- G. Up to 250 "custom" LCD display screens can be defined by the OEM, each screen can contain descriptive text and up to four items of data to be written/read to/from the PLC.

- H. When configured in AUTORUN mode, configuration options can be password protected, and users can be "locked out" of certain screens.
- I. A "trigger" register allows the PLC to force display of any of the 250 LCD screens. It also can be utilized to force the unit to print from the printer port.

1.3 Hardware Description

The Operator Interface Unit is a microprocessor-based high-performance communications device. The core of the module is the Intel 80C31 microprocessor running at 11.0592 MegaHertz. The "firmware" memory is contained in a 27C512 EPROM. The module is also equipped with 32K bytes of battery backed CMOS static RAM, this memory is used to store the configuration and customization data. The non-replaceable encapsulated lithium batteries will preserve the data for over 10 years without power.

The OIU module incorporates a high-performance RS485 communications port for connection to a Series 90 PLC. It also incorporates a RS232 communications port for connection to an IBM PC (for programming) or a serial printer (for printing messages).

1.4 Specifications

Mounting Requirements:	Panel Mounting, NEMA 4-12
Communications:	RS485, SNP protocol
Additional Communications:	RS232
Power Requirements:	OIU150 : 250mA @ 5VDC (can be supplied by the Series 90 PLC power supply).
	OIU152/175 : 100mA @ 24VDC
Operating Environment:	0 to 60 degrees C (32 to 140 degrees F). 0 to 95% humidity (non-condensing).
Batteries:	Battery backed CMOS static RAM sockets contain non-replaceable encapsulated lithium batteries. Life expectancy is over 10 years without power.

CHAPTER 2: INSTALLATION

2.1 Mounting Requirements

The OIU module is designed for permanent panel mounting. To install the OIU module;

- A. Cut the host panel as described by the drawing in appendix B.
- B. Remove the four #6-32 hex nuts from the outer mounting studs on the rear of the OIU panel. If the rear panel shroud option is installed, remove the shroud.
- C. Insert the OIU module through the front panel cutout (be VERY careful not to pinch or stress the keypad cable). The gasket material should lie between the host panel and the OIU panel.
- D. Install four #6-32 hex nuts on the four mounting studs of the OIU module. Tighten these nuts until that the gasket material forms a tight seal, **do not** overtighten.
- E. If the rear panel shroud option is present, install the shroud over the mounting standoffs and secure with four #6-32 screws included. This completes the mechanical mounting of the OIU module.

2.2 Power Requirements

The OIU150 module requires approximately 250mA @ 5 Volts DC for normal operation. This power can be obtained from the Series 90 programming port or from an external power supply. The OIU152/175 module requires 100mA @ 24VDC for normal operation. **IF AN EXTERNAL SUPPLY IS USED, DISCONNECT THE +5V LEAD FROM THE COMMUNICATIONS CABLE.**

2.3 Communications Cable

Horner Electric offers a six foot communications cable, fully assembled and tested. If the user wants to build a custom cable, the information is supplied in appendix A of this manual. This cable will allow direct connection to any Series 90 PLC. It has the identical pinout as the GE Fanuc Hand-Held Programmer Cable.

2.4 Series 90 CPU Configuration

Before attempting communications between the OIU module and the Series 90 CPU, the Series 90 CPU must be configured as follows;

- A. The password must be disabled in the Series 90 CPU using the GE Fanuc Hand-Held Programmer or Logicmaster 90 (see the Series 90 User's Manual for details). Failure to disable the password will prevent access to the PLC's data.
- B. The PLC ID must be set to null, using the Hand-Held Programmer or Logicmaster 90 (see the Series 90 User's Manual for details). An ID with a value other than null will prevent access to the PLC's data.
- C. Only one Series 90 CPU can be accessed on the RS485 connection, the SNP "multi-drop" network is not supported by the OIU module. Attempting to communicate to more than one PLC will prevent access to any PLC data. The Horner Electric SNP Multiplexer (HE693SNPMPX) will allow multiple SNP devices, including the OIU150/152/175, to be connected to one Series 90 PLC.

CHAPTER 3: INITIAL OPERATION

This chapter assumes that the OIU module has been mounted and that the communications cable has been properly connected. Power can now be applied to the Series 90 and to the OIU module. The display on the OIU module should respond with the following sign-on message;

```
HORNER ELECTRIC  
OIU150 SNP V1.00
```

This message will remain on the display for approximately 3 seconds. If the sign-on message does NOT appear on the display, consult chapter 7 (troubleshooting). After the sign-on message has been displayed for 3 seconds, the first two lines of the "MAIN MENU" will be shown on the LCD display;

```
→RS485 Set-up  
RS232 Set-up
```

3.1 Running the Self Test

At this point, the module is in a mode whereby the operator may select a MAIN MENU item. Navigation through the OIU module's menu system is discussed in detail later in this manual, however the SELF TEST should be executed during the initial operation in order to verify that the OIU module is properly connected and fully functional. To do this, press and hold the "down arrow" key until the menu pointer reaches the "Self Test" menu line (the Self Test is the sixth and final menu selection, the pointer will stop when it reaches the Self Test line). Press the ENTER key to begin the Self Test. The Self Test will perform the following eight tests:

1. System RAM memory test,
2. Keypad / Display test,
3. RS-485 Loopback test,
4. RS-232 Loopback test,
5. Real-time calendar clock test,

(self tests, continued)

6. LCD / VF display contrast test,
7. Non-Volatile RAM test, and
8. Watchdog reset test.

The system memory test will display the amount of memory (in "K" bytes) present, this value should be 32K bytes. If a value other than 32K is displayed following completion of the RAM test, a serious hardware problem exists.

When the Keypad / display test is running the message "**Press a key...**" will be displayed. Each time the user presses a key on the keypad, the key's value is displayed on the second line of the display. If a key is pressed and its value is not displayed, a keypad problem exists. By pressing the "SHIFT" and "ENTER" keys simultaneously, the keypad / display test is terminated.

The RS485 and RS232 loopback tests are valid only if the special "loopback" connectors are present on each port. If the loopback connector is present, and the test passes, an OK message will be displayed. If the tests fails with a loopback connector present, an ERROR! message is displayed and a port failure is indicated. In the event of test failure, with or without loopback connector, pressing "ENTER" will allow the self test to continue.

The real time calendar clock test will show the unit's current date and time. If, after pressing an arrow key, the time (seconds) is not changing, an error is present. (If desired, the time may be set at this time. See "Setting the Calendar Clock", later on in this Chapter.) Pressing ENTER" will allow the self test to continue.

The LCD / VF display contrast control test will allow users to adjust the display contrast by pressing the up and down arrows. Most users leave the display set at maximum contrast. Pressing "ENTER" will allow the self test to continue.

The non-volatile RAM test requires the user to cycle the OIU module's power. A pattern is written to the OIU's NV-RAM memory and this pattern is checked following power-up. If the pattern is valid, the NV-RAM test will pass. If the OIU module displays a NV-RAM FAIL message, the battery-backed memory socket is defective.

The watchdog test will simply perform a hardware reset of the OIU module (just as if the power had been turned off and then back on).

If any of these tests fail, refer to chapter 7, troubleshooting.

3.2 Operating Modes

The OIU module operates in two modes: SETUP mode and AUTORUN mode. When shipped from the factory, the module will enter SETUP mode when powered up. The module can be customized and configured while in SETUP mode and then placed in AUTORUN mode. Both modes are briefly discussed below.

3.3 Set-up Mode

SETUP mode is designed for use by the OEM for configuration and customization of the OIU module. When in SETUP mode, the OEM can configure the module's serial port communication parameters, define custom display "screens", monitor and change PLC data registers, and perform other configuration operations. A password can be defined while in SETUP mode to prevent access to SETUP mode once the module has been placed in AUTORUN mode. The module is placed into AUTORUN mode from the SETUP mode.

3.4 Autorun Mode





AUTORUN mode is designed for use by the OEM's end customer. Once the module has been placed in AUTORUN mode, only the custom display "screens" can be accessed. When in AUTORUN mode, the module will automatically enter the AUTORUN mode after power-up. In order to return to SETUP mode, the user must correctly enter the optional password.

CHAPTER 4: THE MAIN MENU

When shipped from the factory, the OIU module will display the sign-on message for approximately 3 seconds following power-up, followed by the display of the MAIN MENU. The MAIN MENU consists of six menu items;

- | | |
|-----------------|---------------|
| RS485 Set-up | Customization |
| RS232 Set-up | Set Clock |
| PLC Data Access | Self Test |

Since the LCD display only provides two lines, only two of the menu items will be displayed at a time. A flashing "pointer" is displayed in the leftmost display column to designate which menu item is currently "active". The menu pointer is positioned using the UP and DOWN arrow keys on the front panel keypad. If the pointer is on the second line of the display and the DOWN arrow key is pressed, the display will "scroll" to reveal the next menu item and the pointer will point to the newly displayed selection. Once the end of the menu is reached, the display will no longer scroll down.

Display	Key(s)	Comments
→RS485 Set-up RS232 Set-up		When the first two lines of the MAIN MENU are displayed, the pointer is moved by pressing the DOWN arrow key.
RS485 Set-up →RS232 Set-up		The DOWN arrow key will continue to move the pointer until the last menu item is reached.
RS232 Set-up →PLC Data Access		
PLC Data Access →Customization		When the bottom of the menu is reached, the pointer will no longer move when the DOWN arrow key is pressed, however the UP arrow key will cause the pointer to move back up through the menu items.
Customization →Set Clock		
Set Clock →Self Test		

When the menu pointer has been moved to the desired menu item, the ENTER key is pressed to activate the selected function.

4.1 RS485 Set-up

The RS485 Set-up is the first item on the main menu. It is selected by placing the main menu pointer on the RS485 Set-up menu item and pressing the ENTER key. This selection allows the user to configure the OIU module's SNP port communications parameters. Doing so will cause the display to change to the following;



```
→Baud Rate: 19200
Parity:      Odd
```

RS485 Set-up is also menu oriented. The RS485 Set-up menu consists of four menu items which can be configured. Each menu item is shown below with the range of acceptable configuration values and (in boldface type) the factory default value;

1. Baud rate: (300, 600, 1200, 2400, 4800, 9600, **19200**)
2. Parity: (None, **Odd**, Even)
3. Data bits: (**7**, 8)
4. Stop bits: (**1**, 2)

The RS485 Set-up menu is similar to the Main Menu in that a flashing menu pointer is displayed in the leftmost position of the LCD display to designate which menu item is currently active. This menu differs from the Main Menu in that all four menu items each contain a configurable parameter.

A different value for one of the configurable parameters is selected by moving the menu pointer to the desired item and pressing the RIGHT or LEFT arrow keys to sequence through the available values. Once the desired value is shown, the ENTER key must be pressed in order to invoke the selected parameter. If the value shown is different from the current configuration, the configuration value will flash. This is to inform the user that the current operation has not yet been put into effect. If the UP or DOWN arrow keys are pressed (moving the menu pointer) before the ENTER key is pressed, the original value is restored for the current parameter.

All of the RS485 port configuration values are retained in battery-backed memory and will be invoked at power-up.

4.1.1 Baud Rate Selection

The baud rate is the rate at which data is passed between the OIU module and the Series 90 CPU. This value is determined by the configuration of the Series 90 CPU. To configure the OIU module for a different baud rate, simply press the LEFT or RIGHT arrow key until the desired value appears, and then press the ENTER key.

4.1.2 Parity Type Selection

Parity is a type of "built-in" error checking for serial communications. The OIU module's parity configuration must match that of the slave Series 90 CPU. To configure the OIU module for a different type of parity, simply press the LEFT or RIGHT arrow key until the desired value appears, and then press the ENTER key.

4.1.3 Data Bit Selection

The number of data bits must also match that used by the Series 90 CPU. To configure the OIU module for a different data bit parameter, simply press the LEFT or RIGHT arrow key until the desired value appears, and then press the ENTER key.

4.1.4 Stop Bit Selection

The number of stop bits must also match that used by the slave Series 90 CPU. To configure the OIU module for a different stop bit parameter, simply press the LEFT or RIGHT arrow key until the desired value appears, and then press the ENTER key.

4.1.5 Returning to the Main Menu

When all of the RS485 serial port parameters have been configured, the user may hit the "MODE" key to return to the main menu. This will cause the module to return to the MAIN MENU, with the pointer on the "RS485 Set-up" selection.

4.2 RS232 Set-up

The RS232 Set-up is the second item on the main menu. It is selected by placing the main menu pointer on the RS232 Set-up menu item and pressing the ENTER key. This selection allows the user to configure the OIU module's programmer/printer port communications parameters. Doing so will cause the display to change to the following;

```
→Baud Rate: 19200
Parity:      Odd
```

RS232 Set-up is also menu oriented. The RS232 Set-up menu consists of four menu items which can be configured. Each menu item is shown below with the range of acceptable configuration values and (in boldface type) the factory default value;

1. Baud rate: (300, 600, 1200, 2400, 4800, 9600, **19200**)
2. Parity: (None, **Odd**, Even)
3. Data bits: (7, **8**)
4. Stop bits: (**1**, 2)
5. Main Menu

The RS232 Set-up menu is similar to the Main Menu in that a flashing menu pointer is displayed in the leftmost position of the LCD display to designate which menu item is currently active. This menu differs from the Main Menu in that all four menu items each contain a configurable parameter. This menu is virtually identical to the RS485 Set-up menu.

A different value for one of the configurable parameters is selected by moving the menu pointer to the desired item and pressing the RIGHT or LEFT arrow keys to sequence through the available values. Once the desired value is shown, the ENTER key must be pressed in order to invoke the selected parameter. If the value shown is different from the current configuration, the configuration value will flash. This is to inform the user that the current operation has not yet been put into effect. If the UP or DOWN arrow keys are pressed (moving the menu pointer) before the ENTER key is pressed, the original value is restored for the current parameter.

All of the RS232 port configuration values are retained in battery-backed memory and will be invoked at power-up.

4.2.1 Baud Rate Selection

The baud rate is the rate at which data is passed between the OIU module and the serial printer. This value must match that set on your serial printer or IBM compatible computer. To configure the OIU module for a different baud rate, simply press the LEFT or RIGHT arrow key until the desired value appears, and then press the ENTER key.

4.2.2 Parity Type Selection

Parity is a type of "built-in" error checking for serial communications. The OIU module's parity configuration must match that of the serial printer or IBM compatible computer. To configure the OIU module for a different type of parity, simply press the LEFT or RIGHT arrow key until the desired value appears, and then press the ENTER key.

4.2.3 Data Bit Selection

The number of data bits must also match that used by the serial printer or IBM compatible computer. To configure the OIU module for a different data bit parameter, simply press the LEFT or RIGHT arrow key until the desired value appears, and then press the ENTER key.

4.2.4 Stop Bit Selection

The number of stop bits must also match that used by the serial printer or IBM compatible computer. To configure the OIU module for a different stop bit parameter, simply press the LEFT or RIGHT arrow key until the desired value appears, and then press the ENTER key.

4.2.5 Returning to the Main Menu

When all of the RS232 serial port parameters have been configured, the user may hit the "MODE" key to return to the main menu. This will cause the module to return to the MAIN MENU, with the pointer on the "RS232 Set-up" selection.

4.3 PLC Data Access

The OIU module is capable of monitoring the system memory registers inside the Series 90 CPU. The user can also modify many of these registers using the OIU module.

To enter the PLC Data Access mode, simply move the Main Menu pointer to the PLC Data Access line and press the ENTER key, the following will appear on the LCD display;

Enter Data Type:
%R

At this point, the user must select the type of register and the register "offset" or register "number" to monitor or modify. As always, the user can return to the main menu by pressing the MODE key.











4.3.1 Data Type Selection

The Series 90 utilizes several different data "types". This data is used by the Series 90 ladder program to represent I/O points, internal coils, data registers, etc. The Series 90 data types accessible via the OIU module are listed below:

Designator	Register Type
%R	Register (word)
%AI	Analog Input (word)
%AQ	Analog Output (word)
%I	Discrete Input (bit)
%Q	Discrete Output (bit)
%T	Discrete Temporaries (bit)
%M	Discrete Internals (bit)
%S	System Discrettes (bit)
%SA	System Discrettes (bit)
%SB	System Discrettes (bit)
%SB	System Discrettes (bit)
%G	Genius Global data (bit)

Pressing the UP or DOWN arrow keys will cause the register "type" field to sequence through the types listed above. The register "offset" or number is entered via the numeric keypad. A maximum of 4 digits are allowed. Note that the LEFT arrow key can be used to perform a "backspace" operation on the numeric entry, and the CLEAR key can be used to completely erase the numeric entry. When the desired register type and number are displayed, the ENTER key is pressed to invoke the data monitor mode.

For example, if the user wishes to monitor the analog output #30 (%AQ30), the following sequence would be used;

Display	Key(s)	Comments
		With the Main Menu pointer on the PLC Data Access line, press the ENTER key...
		Press the down arrow button until the %AQ register type appears (in this case, twice)...
		
		The register number is selected using the numeric keypad...
		
		With both the register type and number correctly chosen, the ENTER key will cause the module to enter the monitor mode.

4.3.2 PLC Data Monitoring

Following the above example, the OIU module will display the register type, register number and the current value of the register in the PLC (provided that the OIU is properly connected to a Series 90 PLC). The actual format of the displayed data is dependant on the type of register displayed and on the display "base". Upon entry into the monitor mode, the "decimal" display base is always selected. The selected register's value will be displayed on the first line of the LCD display in 16-bit unsigned decimal format. Up to five decimal digits will be displayed.

While in monitor mode, the UP and DOWN arrow keys can be pressed to sequence through the available register numbers. If the "end" of the selected register space is reached, the module will "wrap around" to the first value. Pressing the MODE key will cause the module to return to the register selection mode.

Pressing the DEC/HEX/BIN key will cause the format of the displayed data to change. Each successive pressure of the DEC/HEX/BIN key will cause the format to change to;

1. 16-bit Hexadecimal
2. 16-bit Binary
3. 1-bit (displayed as "On" or "Off")
4. 16-bit two's complement signed decimal

4.3.3 Reading Decimal Data

When PLC data is displayed during monitor mode in the 16-bit two's complement signed decimal base, the values displayed will contain up to five decimal digits and an optional sign if the value displayed is negative. Leading zeroes are suppressed. If the register type selected is a "word" value (%R, %AI, or %AQ), the second line of the LCD display will contain the next consecutive register number. If the last available data item is displayed on the first line of the LCD display, the second line will contain the first register number.

If the register type being displayed is a "bit" type register, the first line of the LCD display will contain a decimal value that represents the current state of the selected bit AND the next consecutive 15 bits. The second line of the display will contain a value that represents the current state of the subsequent 16 bits of the same type. For instance, if the user chooses to display bit %I9, the first line will contain a decimal value that represents the state of bits %I9 to %I24, while the value on the second line will correspond to registers %I25 to %I40.

When displaying bit data, the register tables can be thought of as "circular". This means that if a 16-bit "bit" register is displayed that includes the last available bit register of a given type, the remaining bits of the displayed value will represent the first bits of that type. For example, if %I505 is displayed (with the last %I register being %I512) the value is represented as follows;

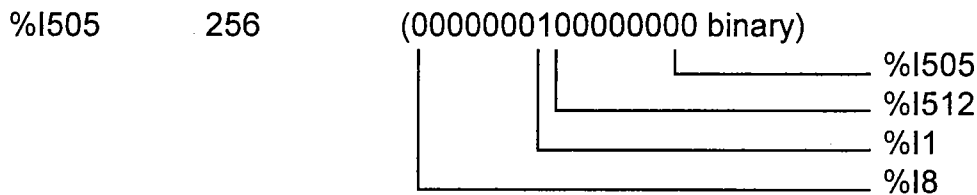

The UP and DOWN arrow keys allow the user to "scroll" through the selected register table. If the selected register table is a "bit" type register, each activation of the UP or DOWN arrow keys will cause the displayed value to increment or decrement to by 16 bits. During 16-bit register displays, the UP and DOWN arrow keys will cause the displayed value to increment or decrement by one.

4.3.4 Reading Hexadecimal Data

When PLC data is displayed during monitor mode in the 16-bit Hexadecimal base, the values displayed will contain four hexadecimal decimal digits, followed by the "H" character. Leading zeroes are displayed. All other attributes are identical to those described above for decimal display of data.

4.3.5 Reading Binary Data

When PLC data is displayed during monitor mode in the Binary base, only ONE 16-bit binary value will be displayed on the second line of the LCD display.

The UP and DOWN arrow keys allow the user to "scroll" through the selected register table. If the selected register table is a "bit" type register, each activation of the UP or DOWN arrow keys will cause the displayed value to increment or decrement by 1 bit. This will give the effect of "shifting" the binary value to the right or left. During "word" register displays, the UP and DOWN arrow keys will only cause the displayed value to increment or decrement by one 16-bit register.

4.3.6 Reading On/Off Data

When PLC data is displayed during monitor mode in the On/Off base, two consecutive registers, either bit or word type, will be represented. If a word type register is selected, the value displayed (On or Off) will represent the state of the LEAST SIGNIFICANT BIT of the word register. If a bit register is selected, two consecutive bit values will be displayed.

The UP and DOWN arrow keys will function exactly as described above for the binary base.









4.4 Changing PLC Data

During monitor mode, the user can change the PLC data value displayed and cause the OIU module to "write" the new value to the PLC. This is done by selecting the desired "base" for the display and then pressing the RIGHT arrow key. This will cause the selected data item to flash, indicating that the numeric entry mode is active. The action taken by the OIU module is dependant on the current display base selected.

4.4.1 Writing Decimal Data

If the 16-bit two's complement signed decimal base is selected when numeric entry mode is invoked, the current value of the register on the top line of the LCD display will flash. If this value changes, the displayed value will be updated. If the user presses one or more numeric keys (0 through 9), the value entered will then be displayed in place of the original PLC data value. The LEFT arrow key can be used to perform a "backspace" operation and the CLEAR key can be used to completely erase the numeric entry.

When the desired replacement value has been numerically entered, the ENTER key is pressed to cause the OIU module to "write" the value to the PLC. The following sequence assumes that the OIU module is already monitoring register %AQ30. This sequence will write a decimal value of -1234 to the register;

Display	Key(s)	Comments
<pre>%AQ0030 0 %AQ0031 0</pre>		With the desired register on the top line of the LCD display, pressing the RIGHT arrow key will invoke "numeric entry" mode, causing the current value to flash.
<pre>%AQ0030 0 %AQ0031 0</pre>	   	This key sequence will cause the entered value to be displayed in place of the original PLC value (nothing is written to the PLC until the ENTER key is pressed).
<pre>%AQ0030 1234 %AQ0031 0</pre>	 	The SHIFT key must be used in order to access the "-" function.
<pre>%AQ0030 -1234 %AQ0031 0</pre>		Pressing the ENTER key causes the new value to be written to the PLC.

If no numeric value has been entered when the ENTER key is pressed, nothing is written to the PLC.

After the ENTER key has been pressed and the new value is written to the PLC, the OLD value might appear on the display for an instant. This is because the OIU module will not recognize that the value has changed until the PLC responds to the OIU module's request for the current value. The old value will be displayed for the amount of time required to write the new value and then read the new value from the PLC.

4.4.2 Writing Hexadecimal Data

Writing data to the PLC while displaying data in the Hexadecimal base is identical to that in decimal base except that data is entered in up to four hexadecimal digits. However, alphanumeric values (A-F), are not writeable.

4.4.3 Writing Binary Data

When the binary base is selected and the numeric entry mode is invoked, only the LEAST SIGNIFICANT BIT of the displayed binary value will flash. The "1" key can be pressed to force this bit to it's ON state while the "0" key will force this bit to it's OFF state. The new value will not be written until the ENTER key is pressed.

4.4.4 Writing On/Off Data

The On/Off base is similar to the binary base in that the "1" and "0" keys will cause the displayed bit to turn ON and OFF respectively. The new value will not be written until the ENTER key is pressed.

4.5 Customization

The fourth item on the Main Menu is the CUSTOMIZATION option. To invoke the customization menu, move the main menu pointer to the customization line and press the ENTER key. The customization menu is discussed in Chapter 5.

4.6 Setting the Clock

The next item on the Main Menu is the SET CLOCK option. This option allows the user to perform three functions; set the clock for the proper date and time, select the registers in the PLC to which the OIU will download date and time information, and select the time interval at which the OIU updates the PLC registers.

4.6.1 Setting the Time and Date

Immediately following the selection of the Set Clock menu item, a screen is displayed with the current stored setting for day of the week, month, date, year, and time. Pressing the right arrow key allows the desired parameter to be selected, and pressing the up and/or down arrow keys allows the current value to be changed. Note that the day of the week is not changeable. The OIU automatically selects the proper day of the week for the date selected. As soon as the time and date are set properly, the user presses ENTER to store the new values.

4.6.2 Selecting the PLC Time and Date Registers

As mentioned previously, time and date information can be downloaded from the OIU to a bank of six PLC registers. After setting the current time and date as described in section 4.6.1, the user is prompted to enter the register number for the first of these six registers (For a description of the six registers and the data they contain, see Table 4-1). To enter the starting clock register, the user must type in the register number (type%R is automatically selected) followed by ENTER. If the downloading of time and date to the PLC is not desired, pressing the CLEAR key (then ENTER) disables the function.

Reg Number	Data Stored	Data Range	Data Type
1	Hour	0-23	BCD
2	Minute	0-59	BCD
3	Day of Week	1-7	BCD
4	Month	1-12	BCD
5	Date	1-31	BCD
6	Year	1991-????	BCD

Table 4-1. Time and Date Registers

4.6.3 Selecting the Time and Date Update Interval

If the starting time and date register has been selected, the user is next prompted to set the interval at which the time and date registers are updated. By pressing the up and/or down arrows, the user can toggle through the available choices. The choices are as follows:

- 1. At power-up only
- 2. Once per minute
- 3. Once per hour
- 4. Once per day

Once the appropriate interval is displayed, pressing ENTER completes the interval selection. This also completes the SET CLOCK procedure.

4.7 The Self Test

The sixth and final Main Menu item is the SELF TEST. The execution of the OIU module's self test is described in Chapter 3.

CHAPTER 5: THE CUSTOMIZATION MENU

The OIU module has been designed for maximum configurability to allow the user to implement the module in most any application. This section describes in detail how to program the custom display screens and how to place the module into AUTORUN mode.

Pressing the ENTER key when the Main Menu pointer is on the Customization item will cause the OIU module to enter the CUSTOMIZATION MENU. This menu consists of 7 menu items;

1. Set Password
2. Define Display
3. Set Trigger Register
4. Autorun
5. Adjust Contrast
6. Define Function Keys
7. High User Screen Number

Movement through the Customization menu and selection of an item in the customization menu is identical to that of the Main Menu (see section 4).

5.1 Setting the Password

Once the OIU module is placed into the AUTORUN mode, it will stay in this mode (even through a power failure) until the user performs the key sequence to exit into SETUP mode. The OEM can define a password to prevent the end user from entering the SETUP mode.

The first item on the customization menu is the SET PASSWORD function. When shipped from the factory, the password function is disabled. To configure the password, the menu pointer is placed on the Set Password menu item and the ENTER key is pressed. One of the following messages will appear on the display;

If no password exists:

New Password?
_

If a password has been defined:

Old Password?
_

If a password has previously been defined, the user must correctly enter the old password before a new password can be defined. If the ENTER key is pressed before any password characters are entered, the password is disabled. During password entry, the LEFT arrow key can be used to perform a "backspace" operation.

The password is numeric, and can contain up to 16 numerals (0 through 9).

5.2 Defining a Custom Display

As stated previously, the OIU module can be programmed with up to 250 custom display "screens". Selecting the second item on the customization menu (Define Display) will cause the following message to appear on the display;



5.2.1 Selecting the Display Number

At this point the user must enter a screen number (0 through 249) that represents the screen number to be configured. As soon as a numeric key is entered, the text of the selected screen will be displayed, and a flashing cursor will appear in the first display position.

When shipped from the factory, all 250 of the programmable display screens are filled with spaces, therefore the display will appear to be "blank".

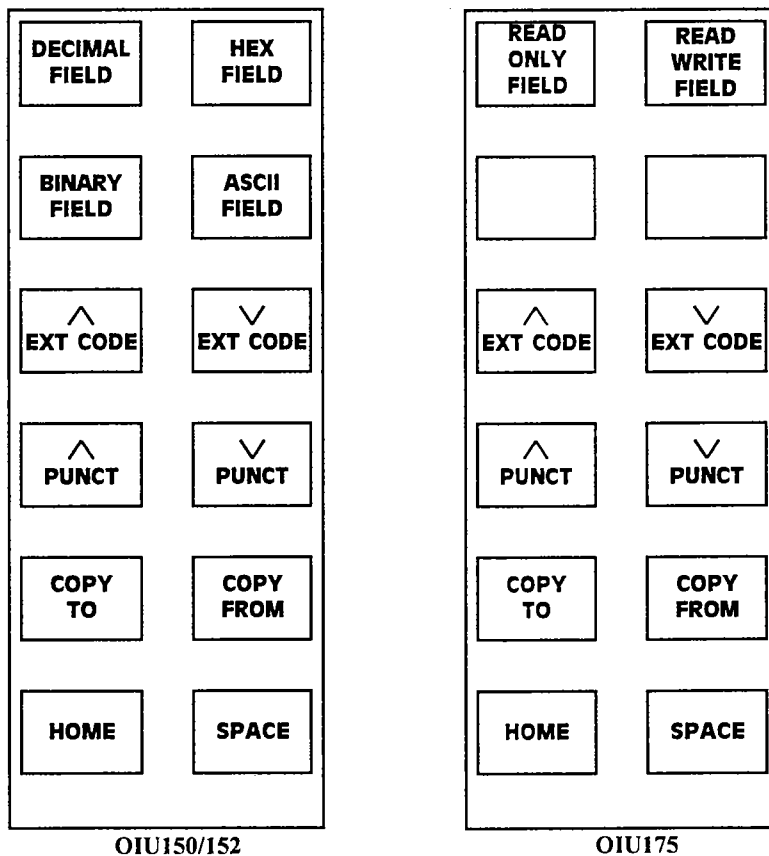

Function Key Customization Insert

5.2.2 Using the Function Key Customization Insert

Before going ahead with the screen customization process, it is advisable for the programmer to insert the customization insert over the 12 function keys. The function keys play a major part in the programming of the unit. The exact function of each of the keys during the configuration process is detailed later on in this chapter. A diagram of the function key insert is shown on the previous page.

5.2.3 Defining the Display Text

The user can configure the selected "screen" with up to 32 characters of text, each character of which can be any displayable ASCII character. The text for the selected display screen is defined one character at a time.

ALPHANUMERIC CHARACTER DISPLAY

Entering Alphanumeric Characters is accomplished via the numeric keypad. Each key (except 0) is labelled with both a numeral and two or three letters. The letters correspond to the standard labelling on a telephone keypad, with the exception of the 1 key. For example, the "2" key contains the alphabetical label of "ABC". To enter an "A" press the key once. To enter a "B", press the key twice. To enter a "C", press three times. To enter a "1" press four times. To change the case, (for example, from "A" to "a") press the shift key after choosing the proper letter.

PUNCTUATION CHARACTER ENTRY

Entering punctuation characters involves the use of two of the function keys. Keys F7 and F8 are labelled "PUNCT UP" and "PUNCT DOWN" on the programming insert. These keys are used to sequence up and down through the set of punctuation characters. Also, a space character can be inserted by pressing the F12 key. The chart on Page 5-6 lists all available punctuation characters.





























EXTENDED CHARACTER ENTRY

Entering characters from the extended character set also involves using two function keys. Keys F5 and F6 are labelled "EXT CODE UP" and "EXT CODE DOWN". These keys are used to sequence up and down through the extended character set. The chart on Page 5-6 lists all available extended characters.

The LEFT, RIGHT, UP and DOWN arrow keys are used to move the cursor. Movement of the cursor does not affect the characters on the display. The cursor will "wrap" from one line to the other if moved beyond the last (or first) character position. The F11 key can be used to bring the cursor to screen position 1, the "HOME" position.

When finished with character entry, the user presses the ENTER key. The OIU module will then return to the "Enter Display #" mode, allowing the user to select a new display for configuration or editing.

The following example reviews the character entry process. In the example, Screen #200 is to be used to enunciate a machine failure condition.

Display	Key(s)	Comments
Enter Display # (0 to 249): 000	   	After the "Define Display" item has been selected on the Configuration Menu, the unit will prompt the user for the display number to be defined. This key sequence selects Screen #200 and brings up a blank screen.
-	   	Hitting the "3" key three times causes an F to appear in the first position. Right arrow moves to the next position.
F_	  	The next sequence of keys enters each letter in succession. Pressing the SHIFT key after selecting the proper letter selects a lower case.
Fa_	    	
Fai_	    	
Fail_	   	
Failu_	   	

Display	Key(s)	Comments
Failur_	<div style="display: inline-block; border: 1px solid black; padding: 2px; margin-right: 5px;">DEF 3</div> <div style="display: inline-block; border: 1px solid black; padding: 2px;">DEF 3</div>	(Display Definition Example, continued)
	<div style="display: inline-block; border: 1px solid black; padding: 2px; margin-right: 5px;">SHIFT</div> <div style="display: inline-block; border: 1px solid black; padding: 2px;">↵^x</div>	
Failure_	F7	To add an exclamation mark to the end of the message, the punctuation function key must be used. Pressing F7 (PUNCT UP) once will cause the exclamation mark to be displayed.
Failure!_	ENTER	Pressing the ENTER key will complete the screen customization process. Another screen may now be defined or edited.
Enter Display # (0 to 249): 000		

The charts on the following pages show all the alphanumeric, punctuation, and extended characters which can be displayed by the OIU150.

0	A	Q	a	q
1	B	R	b	r
2	C	S	c	s
3	D	T	d	t
4	E	U	e	u
5	F	V	f	v
6	G	W	g	w
7	H	X	h	x
8	I	Y	i	y
9	J	Z	j	z
	K		k	
	L		l	
	M		m	
	N		n	
	O		o	
	P		p	

Alphanumeric Character Set

!	;	←
"	<	
#	=	
\$	>	
%	?	
&	@	
'	⌈	
(*	
)	⌋	
*	>	
+		
,	/	
-	<	
.	-	
/	>	
=	+	

Punctuation Character Set

	一	夕	三	α	ρ
◻	ア	チ	△	Δ	□
「	イ	ツ	×	β	θ
」	ウ	テ	モ	ε	∞
、	エ	ト	カ	μ	Ω
・	オ	ナ	∟	σ	ü
ヲ	カ	ニ	ヨ	ρ	Σ
ア	キ	ヌ	ラ	q	π
イ	ク	ネ	リ	r	×
ウ	ケ	ル	ル	、	∟
エ	コ	ハ	レ	i	千
オ	サ	ヒ	ロ	*	万
カ	シ	フ	ワ	φ	円
ユ	ズ	へ	ン	も	÷
ヨ	セ	ホ	ッ	円	
ツ	ソ	マ	◻	○	■

Extended Character Set

5.2.4 Defining PLC Data Display Fields

When defining a custom LCD display screen, the user may also define up to four "fields" to be filled with data from the PLC. A field is a group of one or more adjacent characters on the LCD display. A field can be only one character in length, or as long as 16/20 characters (an entire LCD display line).

A data field is defined by placing special characters in the custom LCD display screen during the screen's definition. Seven of these special characters exist in the OIU150/152 to permit PLC data field definition.



The OIU175 has only two characters.



Each of the characters, when placed in a custom LCD display screen, will represent a single character of a data field to be filled with register data from the PLC. The characters for the OIU150/152 differ by their "base", represented by a single letter; and their arrows, pointing either up or down. The characters with the letter "d" have decimal bases, "H" hex, "b" binary, and "A" Ascii. The same "rules" apply to the display bases as in the monitor mode (see section 4.2). The characters for the OIU175 differ only by the "R" or "W" which correspond to the type of data field (Read or Read/Write). The four display "bases" are;

1. **Decimal** - 16-bit two's complement signed decimal. Data displayed in this base will contain a maximum of six characters (-32767 to -32768) and leading zeroes will be suppressed. If the value to be displayed in the data field is greater in length than the number of characters in the data field, asterisks (*) will be displayed in the data field. The data field can be fewer than five characters in length if the user insures that the value will not exceed the allotted data field size.
2. **HEX** - 16-bit hexadecimal. Data displayed in this base will contain a maximum of four characters (0000 to FFFF) and leading zeroes will be displayed. The user is encouraged to place an "H" character immediately following the data field in order to easily identify the hexadecimal base

during AUTORUN mode. If the value to be displayed in the data field is greater in length than the number of characters in the data field, asterisks (*) will be displayed in the data field. The data field can be fewer than four characters in length if the user insures that the value will not exceed the allotted data field size. Note that only digits 0-9 can be entered during AUTORUN mode, effectively limiting the user to entering BCD data .

3. **Binary, On/Off** - 1 to 16-bit binary. Data displayed in the binary base will consist of up to 16 digits . If a binary base of three characters is configured, one bit will be displayed as "ON" or "OFF".
4. **Ascii** - 1 to 16 characters. Data displayed in the Ascii base will contain exactly the number of characters specified by the data field. The maximum data field size is 16 characters (an entire LCD display line).

The data fields must be defined as either Read or Read/Write fields. Below is a description of each.

1. The reverse negative "R" or the characters with the arrow pointing **AWAY FROM** the field type will define a data field that is READ ONLY. The user will not be able to modify the PLC data register that is configured for display in this field during AUTORUN mode.
2. The reverse negative "W" or the characters with the arrow pointing **TOWARD** the field type will define a data field that is READ/WRITE. The user will be able to modify the value being read from the PLC and write the modified value to the PLC during AUTORUN mode. READ/WRITE fields will continually monitor and update the displayed PLC data value, just as the READ ONLY fields.

The data field characters are accessed by using the function keys with the programming insert installed (see Section 5.2.1). Each data type (decimal, hex, binary, and Ascii) has its own function key (F1-F4). READ ONLY fields are accessed by simply pressing the function key with the appropriate base. READ/WRITE fields are accessed by pressing the function key with the correct base, then pressing the "SHIFT" key to change the arrow to reflect a READ/WRITE character.

5.2.5 Selecting the PLC Data Items

If more than four data fields are defined in a custom LCD display screen, an error message will be displayed to that effect. When any key is pressed, the OIU module will return to the screen editing mode, allowing the operator to reduce the data fields.

Otherwise, the module will prompt the user to select a data register type and number. The UP and DOWN arrow keys are used in this mode to sequence through the available register types, and the register number is entered numerically (up to four digits).

Following is an sample screen with two data fields:

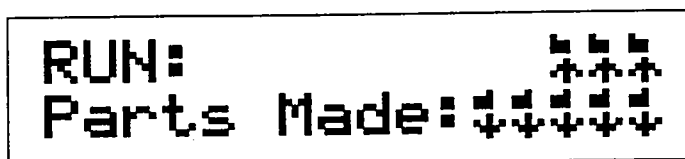

```
RUN:      ***
Parts Made: *****
```

The first data field, "RUN" is a binary field which consists of three characters. Therefore it will be displayed as "ON" or "OFF". The second field, "PARTS MADE" is a decimal field which consists of up to 5 digits. It will be displayed as a number from 0 to 32767. All asterisks will be displayed if the data value reaches 6 digits.

5.2.6 Copying Screens

To aid in the screen configuration process, the "COPY TO" and "COPY FROM" functions were developed. These functions, F9 and F10 on the programming function key insert, allow you to copy entire screen contents from one screen to another. This greatly reduces development time for those applications where many screens are nearly identical, or follow the same format. When COPY TO is selected during the configuration of a screen, the user is prompted for the screen number to which the current screen's contents will be copied. When COPY FROM is selected, the user is prompted for the screen number whose contents are to be copied to the currently selected screen. After completion of the COPY TO or COPY FROM function, the current screen number is maintained.

5.3 Setting the Trigger Register

The PLC program can be written to incorporate a "trigger" register, used to force the OIU module to display or print one of the 250 screens. By utilizing this feature, the PLC can

selectively control the screen displayed to the user at any given moment. This is useful in the enunciation of alarms. For instance, when an alarm condition is detected in the PLC ladder diagram, the PLC can use the "trigger" register to force the OIU to display a screen which notifies the user of the alarm condition. There are a variety of ways in which this feature can be utilized, and also a variety of ladder logic schemes which can be implemented to accomplish them.

For the trigger register feature to be active, the user must choose which of the PLC's registers (%R) is to be used as the "trigger" register. This is accomplished by selecting the "Set Trigger Register" option from the configuration menu. The OIU will prompt the user to enter the desired %R register. Typing the register number followed by ENTER will assign the register. If no PLC triggering is desired, setting the %R offset to NULL will disable the feature. This can be done by pressing CLEAR, then ENTER.

5.3.1 Triggering Screen Changes

When PLC triggering is enabled, the OIU module will continually monitor the value of the specified register during AUTORUN mode. Triggering the OIU to change screens by the PLC is a two step process. The first step is to set the lower eight bits of the trigger register with a value of 0-249, the screen number that is to be changed to. This is typically accomplished with a MOVE function (see your GE Fanuc Series 90 Reference Manual). The second step is to set bit 9 (decimal value 256) of the trigger register, without overwriting the lower eight bits. This is typically accomplished with an OR function. With bit 9 set, the OIU will change to the screen (0 to 249) defined by the lower eight bits of the trigger register. It will then overwrite the trigger register with the screen number that was displayed prior to the switch. Note that the user will not have the ability to change screens from the keypad while bit 9 of the trigger register is on, the PLC will have complete control over display selection. To return screen selection control back to the user, bit 9 must be reset to 0.

5.3.2 Triggering Output to the Printer Port

Triggering output to the printer port is similar to changing screens. First, the lower eight bits of the trigger register are set to the value of the screen that contains the information to be printed. Secondly, bit 10 (decimal value 512) is set without overwriting the lower eight bits. The information will then be printed (along with the time and date), and the OIU will overwrite the trigger register with the current screen number.

5.3.3 Determining the Current Screen Number

Occasionally, it is useful to know which screen the user is currently viewing. To do this, set the trigger register to a decimal value between 250 and 255, and set bit 9 or 10. The OIU will overwrite the trigger register with the current screen number, without changing screens. Note that when feedback to the trigger register is desired, the function which is being executed (MOVE, OR, etc.) should be enabled by a one-shot contact. Otherwise, the ladder logic will write over the information written to the trigger register by the OIU.

5.4 Entering AUTORUN Mode

The next item on the customization menu is the AUTORUN selection. After the user has configured the custom display screens and is ready to place the module in the AUTORUN mode, this option can be selected by placing the menu pointer on the Autorun menu item and pressing the ENTER key. The operator will be prompted to enter a "display number" from 0 to 249. This display number represents the custom LCD display screen that is to be shown after power-up. See Chapter 6 for more information regarding AUTORUN mode operation.

5.5 Adjusting the Display Contrast

The fifth item on the customization menu is the contrast adjustment selection. The contrast of the display will differ depending on the viewing angle. The OIU module allows the operator to adjust the display contrast via the front panel keypad to compensate for differences in various installations. There are two methods whereby the operator can access the contrast adjustment;

1. The operator may select the "Adjust LCD Contrast" menu item by placing the menu pointer on this line and pressing the ENTER key.
2. The operator can press and hold the SHIFT key **AND** the ENTER key during display of the Main Menu, or during AUTORUN mode.

Once the module has been placed in the "adjustment" mode, the UP arrow key can be pressed to increase the display contrast and the DOWN arrow key can be pressed to decrease the display contrast. When the desired contrast is obtained, the ENTER key is pressed to "store" the current contrast setting. The module will then enter the customization menu (or AUTORUN mode if it is in effect).

5.6 Defining Function Keys

The sixth item on the configuration menu is "Define Function Keys". Function keys allow operators to perform commonly executed functions with the push of a single button. The functions, 24 in all (function key and shifted function key), are stored as a sequence of up to 64 keystrokes. In this way they are similar to "macro" functions performed by a variety of computer software. These functions can automate such commonly performed tasks as turning on and off bits (simulating pushbuttons), setting registers to a pre-determined value, etc. For a variety of detailed examples on the use of function keys, see the Horner Electric *Operator Interface Application Guide*, Publication Number **HFK-90-151**.

Because the Function Keys simply store a sequence of keystrokes, it is recommended that the desired keystrokes be performed during AUTORUN mode prior to function key definition. The key sequence can be written down and pre-tested, thus decreasing the chances of error. To define a function key, "Define Function Key" must be selected from the Configuration menu. The OIU will then prompt the user to "Press the Function Key to define...". Once a function key is pressed, the user can enter the desired key sequence, or edit the existing sequence if one exists. Any keys may then be included in the sequence, with the exception of the function keys themselves. After key definition is complete, the user must press the same function key to exit.

5.6.1 Special Keys

Right Arrow: The right arrow key may be included in a function key sequence, but the SHIFT key must first be pressed. When pressed without the SHIFT key, it allows the user to cursor through the key sequence.

MODE: The MODE key is used in the function key process to access data from or change to a particular screen, regardless of the current screen location at the time the key is pressed. The screen is not visibly changed until the end of the function key sequence. Placing MODE 999 at the end of the sequence will force the OIU to return to the original screen. In this fashion, data from other screens can be accessed without the operator seeing any change in screen. When included in a function key sequence, the MODE key is represented by an upper case M.

CLEAR: The clear key should be used following the MODE key to access data from or change to a particular screen. For instance, the key sequence MODE CLEAR 100 ENTER would cause the OIU to change to screen number 100. The CLEAR is represented by an upper case C when included in a function key sequence.

ENTER: When included in a function key sequence, the ENTER key is represented by an upper case E.

SHIFT DELETE: Pressing the SHIFT then DELETE keys deletes a key from the function key sequence during editing.

SHIFT INSERT: Pressing the SHIFT then INSERT key toggles between insert and overstrike mode, in the editing of function key sequences.

5.6.2 Function Key Example

One useful task for a function key is to turn a bit in the PLC reference table "on" or "off". With this simple function, function keys can replace pushbuttons which previously had to be hard-wired. In order to change the status of a bit, a custom screen must exist which contains that data bit. This example will set up a function key to turn on the RUN bit, illustrated previously in the example on Page 5-8.

Display	Key(s)	Comments
→Define FUNC Key Hi User Screen#		The "Define Function Key" option is chosen from the configuration menu.
Press the FUNC key to define...	F1	The function key to be defined is selected, and the key sequence can now be entered.
Define FUNC F1 _	MODE CLEAR ABC DEL ENTER 2 0	The first part of the sequence accesses the screen containing the data to be turned on. This is done by pressing the MODE key, followed by CLEAR and the screen number, the same keystrokes one would perform in AUTORUN mode.
Define FUNC F1 MC20E_	SHIFT	Pressing SHIFT, then right arrow allows the first READ/WRITE data field to be edited...
Define FUNC F1 MC20E>_	QZ ENTER 1	A "1", followed by ENTER sets the bit high.
Define FUNC F1 MC20E>1E_	MODE WXY WXY WXY 9 9 9	During playback of the function, the OIU will not visibly change screens until the completion of the entire sequence. Because no visible screen change is desired, placing "MODE", "9", "9", "9" at the end of the key sequence will prevent it.

```
Define FUNC F1  
MC20E>1EM999_
```

```
F1
```

```
Press the FUNC  
key to define...
```

With the key sequence complete, pressing the function key ends the definition process.

Another function key can now be defined, or the Configuration menu can be accessed by pressing the MODE key.

5.7 High User Screen Number

In many applications, it is not desired for all screens to be accessible directly by the end-user. For example, a screen contains the message, "Machine Failure". That message is normally triggered by the PLC when a machine failure actually occurs. However, if a user unwittingly changed to that screen from the keypad (by pressing the arrow keys or MODE-CLEAR-screen #), it would appear that the alarm was active when it was not. A parameter on the configuration menu, "High User Screen Number", allows the OEM to set a screen boundry beyond which the end user may not access from the keypad. If that boundry was set at 100, the end user could access only screens 0-100 from the keypad. Screens 101-249 would be displayed only if triggered by the PLC. The "unaccessable" screens are also useful for screens which are only sent to the printer, or screens which contain data only accessed during a function key sequence. To set the "High User Screen Number" boundry, simply enter the last accessible screen number followed by ENTER. When an end user presses the MODE key in Autorun mode, he will be prompted to enter a screen number between 0 and the High Screen Number.

CHAPTER 6: AUTORUN MODE

Once the OIU module has been placed in AUTORUN mode, it will remain in AUTORUN mode (even if the power is turned off and back on) until the "exit" key sequence is entered. A password can also be used to prevent access to the SETUP mode when in AUTORUN mode. When in AUTORUN mode, the screen number configured as the "start" screen will be automatically displayed after power-up.

6.1 Changing "Screens"

As stated in the earlier chapters, up to 250 custom screens can be defined by the user. Once in AUTORUN mode, any of these screens can be displayed simply by pressing the MODE key followed by CLEAR and the desired screen number. For example, if the user wants to display screen number 6, he simply presses the MODE key, followed by CLEAR, and then the "6" key. Alternatively, the UP and DOWN arrow keys can also be used to "scroll" through the screens. The user only has access to screens up to and including the High User Screen Number boundary. If the power is lost to the OIU module, it will always revert to the AUTORUN screen number when the power is restored.

6.2 Monitoring PLC Data

When a custom display is shown on the display during AUTORUN mode that contains one or more "data fields", the data field(s) will be filled with the current value of the defined register from the PLC. The data value(s) will continually be updated as fast as the communications protocol between the OIU module and the PLC will allow. When changing screens, question marks will briefly be displayed in data registers until valid PLC data is received.

6.3 Changing PLC Data

When a custom display is shown during AUTORUN mode that contains one or more READ/WRITE "data fields", the data field(s) will read the data from the PLC just as the READ ONLY fields. These data fields can, however, be changed by the user in AUTORUN mode. To write a value to the PLC, the user must press the RIGHT arrow key. The first READ/WRITE data field will flash. If no READ/WRITE data fields exist on the current custom screen, the RIGHT arrow key will be ignored by the OIU module.

If more than one READ/WRITE data field exists on the current screen, the RIGHT arrow key can be pressed again until the desired READ/WRITE data field begins to flash.

The user can now enter a value to be written to the PLC data register defined for the selected data field. The field will continue to monitor and display the PLC data register until the first numeric key is pressed. Once a numeric key has been pressed, the value entered will be displayed in the data field. During numeric entry, the LEFT arrow key can be used to perform a "backspace" operation, and the CLEAR key can be used to completely erase the numeric entry.

All of the rules for numeric entry defined in section 4.3 apply to data entry in AUTORUN mode. The following rules also apply during AUTORUN mode;

1. **Decimal Base** - When entering data where a decimal display base has been defined, the maximum number of characters allowed is either five digits, or the number of characters in the data field, whichever is smaller.
2. **Hexadecimal Base** - When entering data where a hexadecimal base has been defined, the maximum number of characters allowed is either four digits (0 through 9,), or the number of characters in the data field, whichever is smaller. Note that hex digits A-F are not accessible from the keypad. Therefore only BCD information can be written.
3. **Binary Base** - When entering data where a binary base has been selected, only the LEAST SIGNIFICANT BIT can be modified. Pressing the "1" key will force this bit to a logic "1", while pressing the "0" key will clear the bit.

When the numeric entry is complete, the ENTER key is pressed to cause the OIU module to send the new value to the PLC. If the value has not been changed, nothing is sent to the PLC.

The user may notice that after the ENTER key is pressed following a numeric entry, that the "old" value of the affected PLC data register is displayed for an instant prior to the display of the new value. This is due to the amount of time required to send the "write" command to the PLC and then to send the "read" command and receive the data for the affected register. This operation is normal.

6.4 Exiting AUTORUN Mode

Once the OIU module has been placed in AUTORUN mode, it will remain in AUTORUN mode until the exit key sequence is entered. This key sequence is;

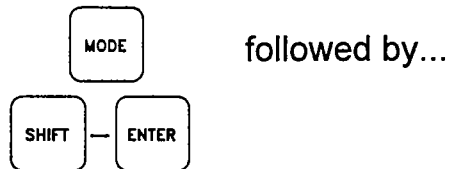

Press and hold SHIFT. Press and release ENTER. Release SHIFT. If no password has been defined, the OIU module will enter the customization menu. If however, a password has been defined, the module will prompt the user to enter the password. Each time a key is pressed, an asterisk (*) will be echoed on the LCD display. If the password is incorrectly entered, the module will re-enter AUTORUN mode, displaying the "start" screen. If the password is correctly entered, the module will return to the customization menu.

CHAPTER 7: TROUBLESHOOTING

The OIU module has been designed for years of trouble-free service, however it is somewhat complex. This chapter provides assistance in areas of common problems.

7.1 Nothing on the LCD / VF Display

If the display is blank following power-up, there are three possible causes;

1. The power supply is incorrectly connected or inoperative. If the display's backlight is illuminated, the power supply is connected properly and is supplying the OIU module power. If the backlight is NOT illuminated, the supply is not working.
2. The display contrast is set such that the display is invisible. The contrast is adjusted via the front panel keypad, see Chapter 5 for details on adjusting the contrast immediately following power-up.
3. The module is in AUTORUN mode and the "start" display is blank. Press the "exit" key sequence (described in Chapter 6) to exit the AUTORUN mode.

7.2 No Communications

The OIU module will display question marks (?) in place of the PLC data whenever it is unable to properly communicate with the slave PLC. (The brief display of question marks is normal when changing screens, however.) The possible causes of a lack of communication are;

1. The communication cable is improperly connected or is defective.
2. The "RS485 Set-up" parameters (accessed via the Main Menu) do not match that of the PLC.
3. Levels 1 & 2 of PLC password protection are not disabled.
4. There is more than one slave PLC on the communications network, or the CPU ID is not set to null.

APPENDIX A: CABLE INFORMATION

PLC COMMUNICATIONS PORT

The following information is provided for those users who may want to build a communications cable of a different length than that of those available. The 15-pin connector on the OIU module provides signals for connection to the Series 90 Programming Port.

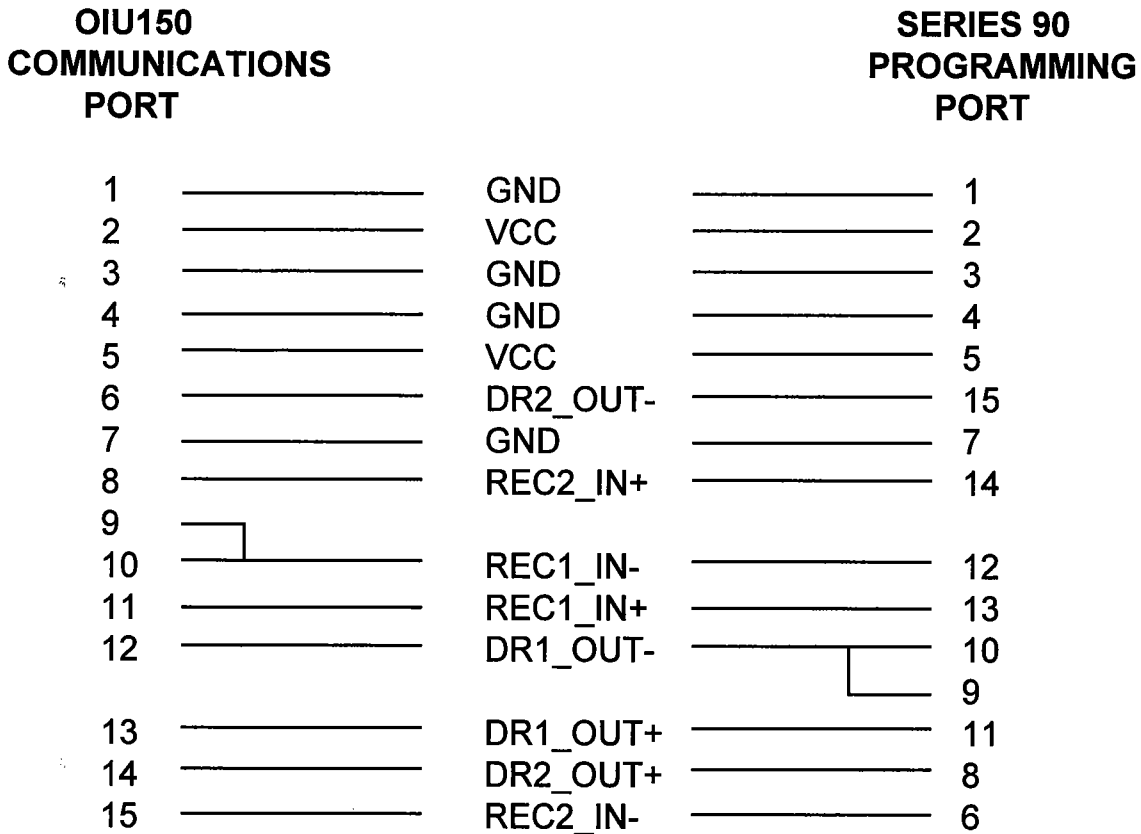

The cable type should be 24 AWG, 30V computer grade. The 15 pin connectors are both male "D" shell type and can be found at most electronic supply vendors. Note that lines 1-5 are for power purposes. For cables greater than 10 feet, these lines should **not** be connected, and an external power supply should be used to power the unit. In this case, pin 5 of the OIU should be connected to the positive lead only on the external power supply, and pin 7 should be connected to the negative power supply lead **and** pin 7 of the SNP port.

PROGRAMMING/PRINTING PORT

9-pin IBM Compatible

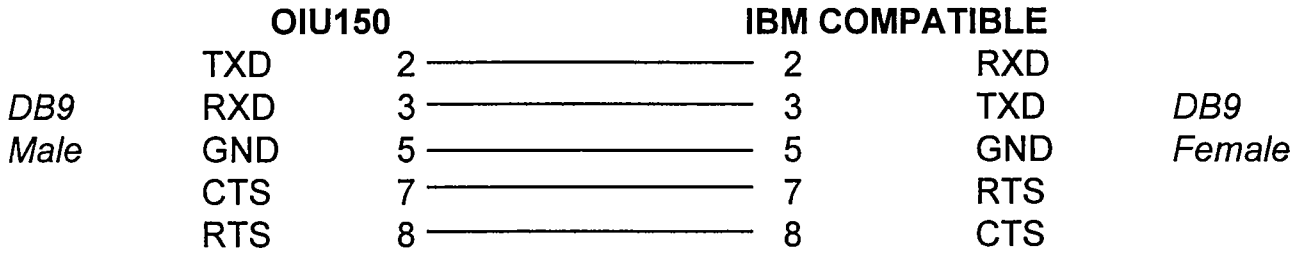

25-pin IBM Compatible

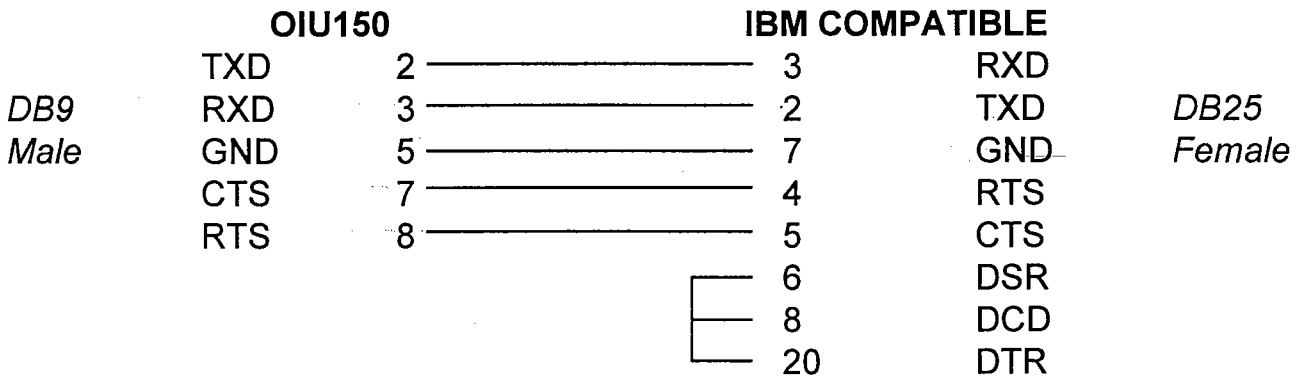

Serial Printer, see your printer manual for verification

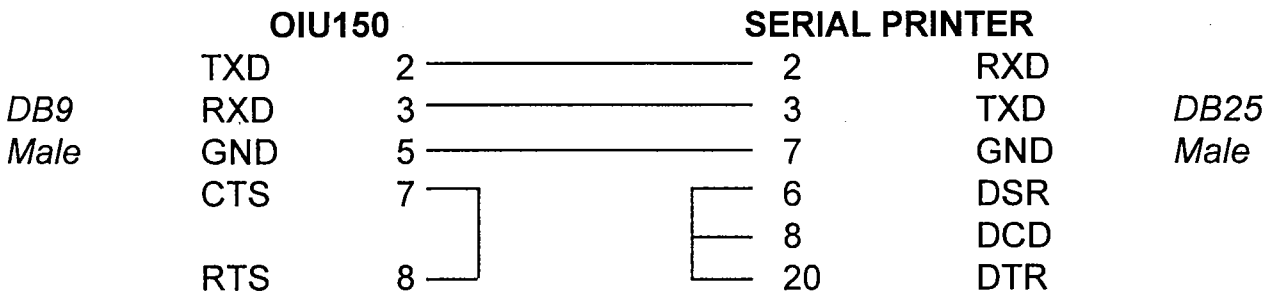

The cable type should be 24 AWG, 30V computer grade. The connectors designated at each cable end are all "D" shell type and can be found at most electronic supply vendors.

APPENDIX B: PANEL CUTOUT

The OIU module is designed for panel mounting. The drawing below illustrates the panel cutout required for OIU module mounting. All dimensions shown in brackets are in millimeters, and those shown without brackets are in inches.

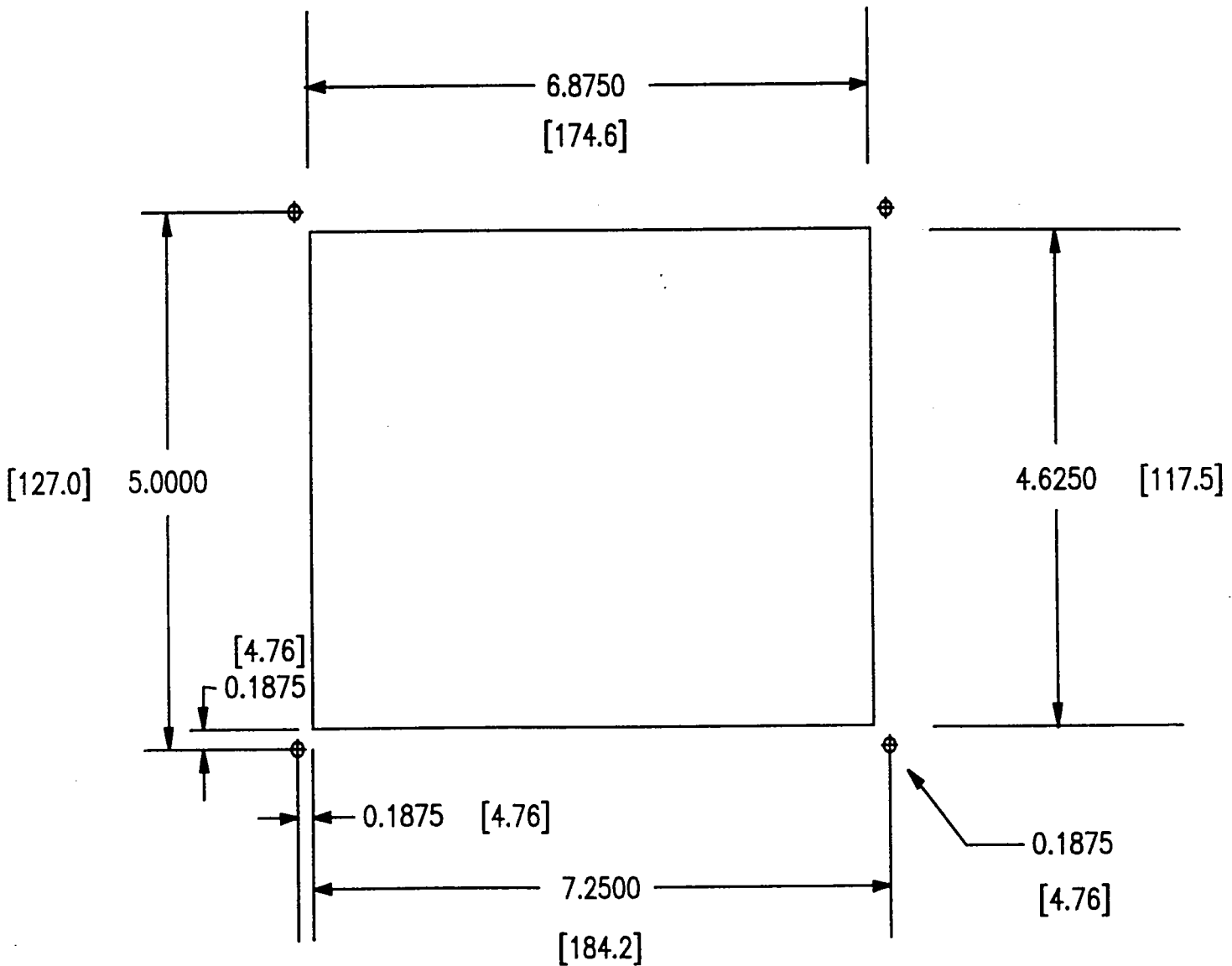

APPENDIX C: FACTORY CUSTOMIZATION

For users who intend to utilize the OIU150/152/175 regularly, a Host Programming Package is recommended. This gives users the ability to develop configurations from computer, store and retrieve configurations from diskette, print out screen listings, etc.

For users that intend to purchase larger quantities of the OIU module for a particular application, the OIU module can be factory configured so that the user does not have to program the screens for each module with the same information. The module will be "pre-configured" for the OEM's application via a custom EPROM and no programming will be required.

For more information regarding this factory pre-configuration, contact Horner Electric or your distributor.

APPENDIX D: OIU152/175 SUPPLEMENT

The OIU152/175 is typically powered by 24VDC. There is a jumper assembly (JP1) which allows the user to select 24V or 5V (from the Series 90 PLC through the communications port) operation. The jumper settings are as follows:

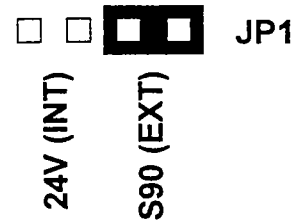
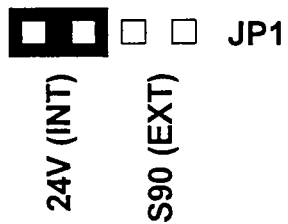

The OIU175 vacuum fluorescent display must be powered by 24VDC. The OIU152 however can be powered by 24V or 5V.

APPENDIX E: MEMORY STORAGE

Battery-backed static RAM sockets for program storage have been replaced by FLASH EPROM (similar to EEPROM) memory. After the OIU150/152/175 has been configured, prior to permanent installation, DIP switch 1 (NVE) on the OIU should be moved to the "open" position to prevent the memory stored in the FLASH EPROM from being changed. This DIP switch is located on the main circuit board of the OIU, and is defined below:

Switch #	Name	Definition when Closed	Default
1	NVE	Flash Not Protected	Closed
2	NVD	Not Used	Closed
3	NVF	Not Used	Closed
4	C64	System EPROM size 64K	Closed
5	WDE	Watchdog Timer Enabled	Closed
6	SW6	Not Used	Closed