



EXL10 OCS DATASHEET

MODEL 5

12 DC In, 12 DC Out, 2 - 14/16-bit Analog In (mA/V/Tc/mV/RTD), 2 - 12-bit Analog Out

1 TECHNICAL SPECIFICATIONS

1.1 General Specifications

Required Power (Steady State)	650mA @ 24VDC
Required Power (Inrush)	25A for < 1ms @ 24VDC, DC switched
Primary Power Range	10 - 30VDC
Relative Humidity	5 to 95% non-condensing
Typical Power Backlight 100%	12.432W @ 24VDC
Power Backlight 50%	9.312W @ 24VDC
Power Backlight OFF	6.048W @ 24VDC
Clock Accuracy	+ / - 20 ppm maximum at 25°C (+/- 1 min/month)
Real Time Clock	Battery Backed, Rechargeable Lithium
Operating Air Temp	-10°C to +60°C
Storage Temp	-20°C to +60°C
Weight (without I/O)	3.9375 lbs (1786g)
Altitude	Up to 2000m
Rated Pollution Degree	Evaluated for Pollution Degree 2 Rating
Certifications (UL/CE)	North America: https://hornerautomation.com/certifications/ Europe: http://www.horner-apg.com/en/support/certification.aspx

1.2 Control & Logic

Control Language Support	Advanced Ladder Logic Full IEC 61131-3 Languages Tag-Based Editor
Logic Program Size	1 MB, maximum
Logic Scan Rate	0.013ms/kB
Digital Inputs	2048
Digital Outputs	2048
Analog Inputs	512
Analog Outputs	512
Gen. Purpose Registers	50,000 (words) Retentive 16,384 (bits) Retentive 16,384 (bits) Non-retentive

1.3 Connectivity

Serial Ports	1 RS-232 and 1 RS-485 on first Modular Jack (MJ1/2) 1 RS-232 or 1 RS-485 on second Modular Jack
USB mini-B	USB 2.0 (480MHz) Programming & Data Access
USB A	USB 2.0 (480MHz) for USB flash drives (2TB)
CAN Port Isolated 1 kV	Remote I/O, Peer-to-peer Comms, Cscape
CAN Protocols	CsCAN, CANopen, DeviceNet, J1939
2 x Ethernet	10/100 Mb (Auto-MDX)
Ethernet Protocols	TCP/IP, Modbus TCP, FTP, SMTP, EGD, ICMP, ASCII, Cscape, Ethernet IP, HTTP
Remote I/O	SmartRail, SmartStix, SmartBlock, SmartMod
Removable Memory	microSD, SDHC, SDXC IN FAT32 format, support for 32GB max. Application Updates, Datalogging, and more
Audio	Mic In, Line In, Line Out

1.4 User Interface

Display Type	10.4" VGA TFT (550 nit typical)
Resolution	640 x 480
Color	16-bit (65,536)
Screen Memory	27MB
User-Program. Screens	1023 max pages; 1023 objects per page
Backlight	LED - 50,000 hour life

1.5 High-Speed Inputs

Number of Counters	4
Maximum Frequency	1MHz Max
Accumulator Size	32-bits each
Modes Supported	Totalizer, quadrature, pulse measurement, frequency measurement, set-point controlled outputs

1.6 High-Speed Outputs

Modes Supported	Stepper, PWM
Output Frequency	500kHz

technical specifications continued...

1.7 Digital DC Inputs

Inputs per Module	12 Including 4 Configurable HSC Inputs	
Commons per Module	1	
Input Voltage Range	12VDC / 24VDC	
Absolute Max. Voltage	35VDC Max.	
Input Impedance	10kΩ	
Input Current	Positive Logic	Negative Logic
Upper Threshold	0.8mA	-1.6mA
Lower Threshold	0.3mA	-2.1mA
Max. Upper Threshold	8VDC	
Min. Lower Threshold	3VDC	
OFF to ON Response	1ms	
ON to OFF Response	1ms	
High Speed Counter Max Freq*	1MHz	

*See I/O info below for detail regarding HSC and PWM

1.8 Digital DC Outputs

Outputs per Module	16 Including 2 Configurable PWM Outputs
Commons per Module	1
Output Type	Sourcing / 10kΩ Pull-Down
Output Frequency	500kHz
Absolute Max. Voltage	28VDC Max.
Output Protection	Short Circuit
Max. Output Current/Point	0.5A
Max. Total Current	4A Continuous
Max. Output Supply Voltage	30VDC
Min. Output Supply Voltage	10VDC
Max. Voltage Drop at Rated Current	0.25VDC
Max. Inrush Current	650mA per Channel
Min. Load	None
OFF to ON Response	1ms
ON to OFF Response	1ms
Output Characteristics	Current Sourcing (Pos. Logic)
PWM Out	≈ 5kHz
Rise Time	50 - 115μs
Fall Time	8-20μs

1.9 Analog Inputs, High Resolution

Number of Channels	2	Thermocouple: B / R / S E T J K / N	Temperature Range:
Input Ranges (Selectable)	0-10VDC; 0-20mA; 4-20mA; 100mV PT100; and J, K, N, T, E, R, S, B Thermocouples		32°F to 2,912°F (0°C to 1,600°C) -328°F to 1,652°F (-200°C to 900°C) -400°F to 752°F (-240°C to 400°C) -346°F to 1,382°F (-210°C to 750°C) -400°F to 2,498°F (-240°C to 1,370°C)
Safe Input Voltage Range	10VDC: -0.5V to +15V 20mA: -0.5V to +6V RTD / T/C: +/- 24VDC	Thermocouple Common Mode Range	+/- 10V
Nominal Resolution	10V, 20mA, 100mV: 14 Bits RTD, Thermocouple: 16 Bits	Converter Type	Delta Sigma
Input Impedance (Clamped @ -0.5 Vdc to 12 Vdc)	Current Mode: 100Ω, 35mA Max. Continuous Voltage Mode: 500kΩ, 25mA Max. Continuous	Max. Error at 25°C (*excluding zero)	*4-20mA +/- 0.10% of full scale *0-20mA +/- 0.10% of full scale *0-10VDC +/- 0.10% of full scale RTD (PT100) +/- 1.0 C° of full scale 0-100mV +/- 0.05% of full scale (*excluding zero)
%AI Full Scale	10V, 20mA, 100mV: 32,000 counts full scale RTD / T/C: 20 Counts / °C	Max. Thermocouple Error (After Warm up Time of One Hour)	+/-0.2% (+/-0.3% below -100°C) of full scale
Max. Over-Current	35mA	Conversion Speed, Both Channels Converted	10V, 20mA, 100mV: 30 Times/Second RTD Thermocouple: 7.5 Times/Second
Open Thermocouple Detec Current	50nA	Conversion Time per Channel	10V, 20mA, 100mV: 16.7 ms RTD, Thermocouple: 66.7 ms
		RTD Excitation Current	250μA

1.10 Analog Outputs

Number of Channels	2	Minimum 10V Load	1kΩ
Output Ranges	0-10VDC , 0-20mA	Minimum Resistance Load	500Ω
Nominal Resolution	12 Bits	Analog Outputs; Output Points Required	2
Update Rate	Once per PLC scan		
Max. Error at 25°C (Exluding Zero)	20mA 0.1% of full scale 0 - 10V 0.1% of full scale	Addtnl. Error for Temp. Other Than 25°C	20mA 0.000143%/ °C 0 - 10V 0.000151%/ °C

2 CONTROLLER OVERVIEW

3 WIRING: INPUTS AND OUTPUTS

2.1 - Overview of EXL10

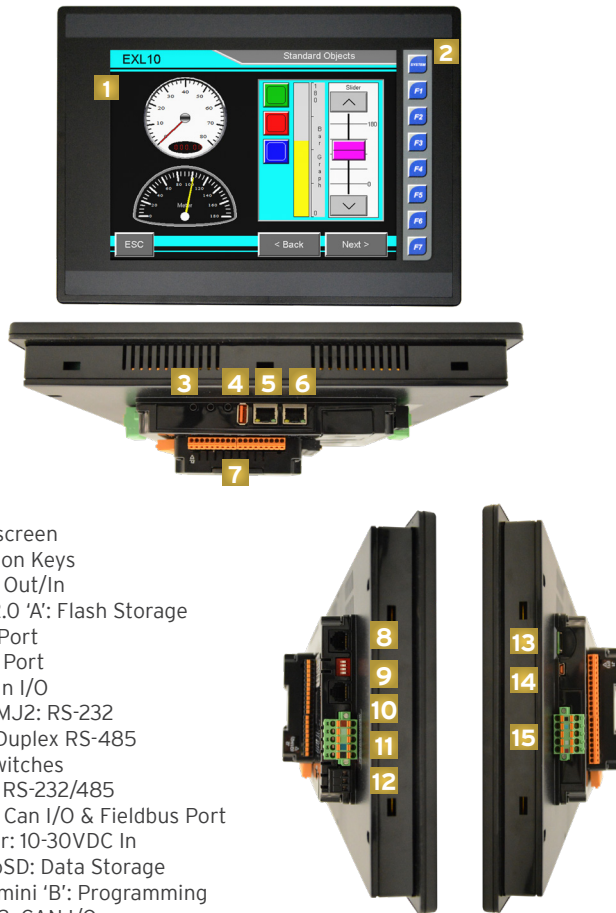

1. Touchscreen
2. Function Keys
3. Audio Out/In
4. USB 2.0 'A': Flash Storage
5. LAN1 Port
6. LAN2 Port
7. Built-In I/O
8. MJ1/MJ2: RS-232 & 1/2 Duplex RS-485
9. Dip Switches
10. MJ3: RS-232/485
11. CAN1: Can I/O & Fieldbus Port
12. Power: 10-30VDC In
13. microSD: Data Storage
14. USB mini 'B': Programming
15. CAN 2: CAN I/O

NOTE: See Precaution #12 on page 6 about USB and grounding.

2.2 - Power Wiring

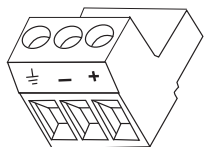

Primary Power Port Pins		
PIN	SIGNAL	DESCRIPTION
1	Ground	Frame Ground
2	DC-	Input Power Supply Ground
3	DC+	Input Power Supply Voltage

DC Input / Frame

Solid/Stranded Wire: 12-24 awg (2.5-0.2mm).
Strip Length: 0.28" (7mm).
Torque Rating: 4.5 - 7 in-lbs (0.50 - 0.78 N-m).
 DC- is internally connected to I/O V-, but is isolated from CAN V-.
 A Class 2 power supply must be used.

POWER UP

1. Attach included ferrite core with a minimum of two turns of the DC+ and DC- signals from the DC supply that is powering the controller.
2. Connect to Earth Ground
3. Apply recommended power.

3.1 - Digital Input & Output Information

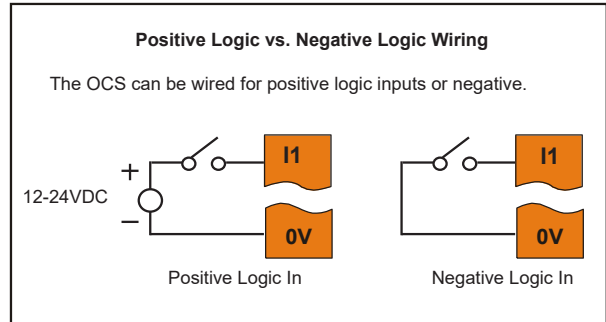

Digital inputs may be wired in either a Positive Logic or Negative Logic fashion as shown. The setting in the Cscape Hardware Configuration for the Digital Inputs must match the wiring used in order for the correct input states to be registered. When used as a normal input and not for high speed functions, the state of the input is reflected in registers %I1 - %I12.

Digital inputs may alternately be specified for use with High Speed Counter functions, also found in the Hardware Configuration for Digital Inputs. Refer to the EXL10 User Manual [MAN1029] for full details.

3.2 - Analog Input Information

Raw input values for channels 12 are found in the registers as Integer-type data with a range from 0 - 32000.

Analog inputs may be filtered digitally with the Filter Constant found in the Cscape Hardware Configuration for Analog Inputs. Valid filter values are 0 - 7 and act according to the following chart.

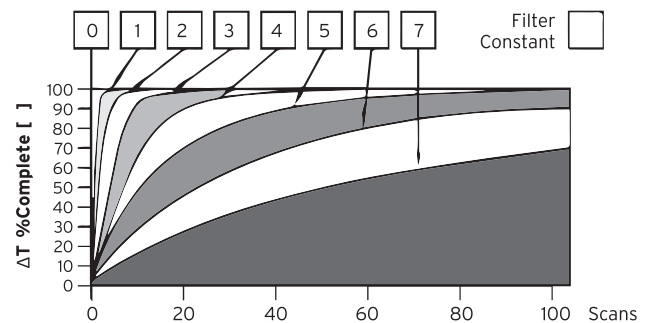

Data Values	
INPUT MODE:	DATA FORMAT, 12-bit INT:
0-20mA, 4-20mA	0-32000
0-10V	0-32000
T/C & RTD	Temperature in °C or °F to 1 decimal place (xxx.y) NOTE: °C or °F may be selected in the Hardware Configuration section in Cscape. The value is an integer, so the user should divide by 20.

Wiring Details:
 Solid/Stranded wire - 12-24 awg (2.5-0.2mm²).
 Strip length - 0.28" (7mm).
 Torque rating: 4.5 - 7 in-lbs (0.50 - 0.78 N-m).

wiring: I-O continued...

3.3- Jumper Setting Details

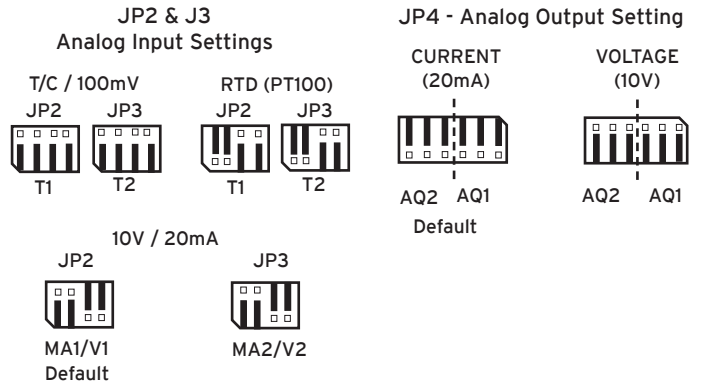
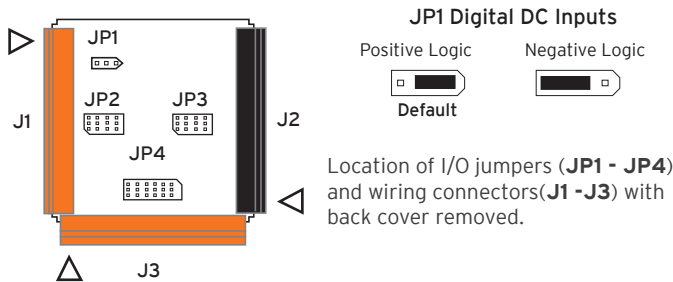

3.4 - Digital In & Out Wiring

Positive Logic - Digital Inputs - J1 Wiring

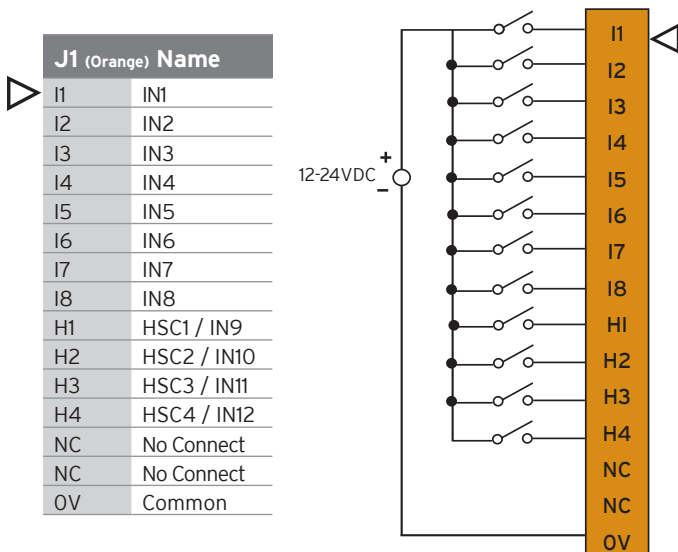

Positive Logic - Digital Outputs - J2 Wiring

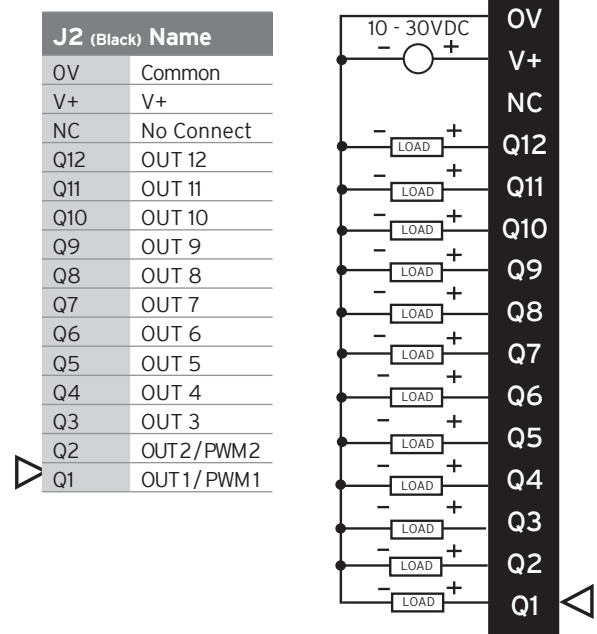

Model 5 - J3 Wiring

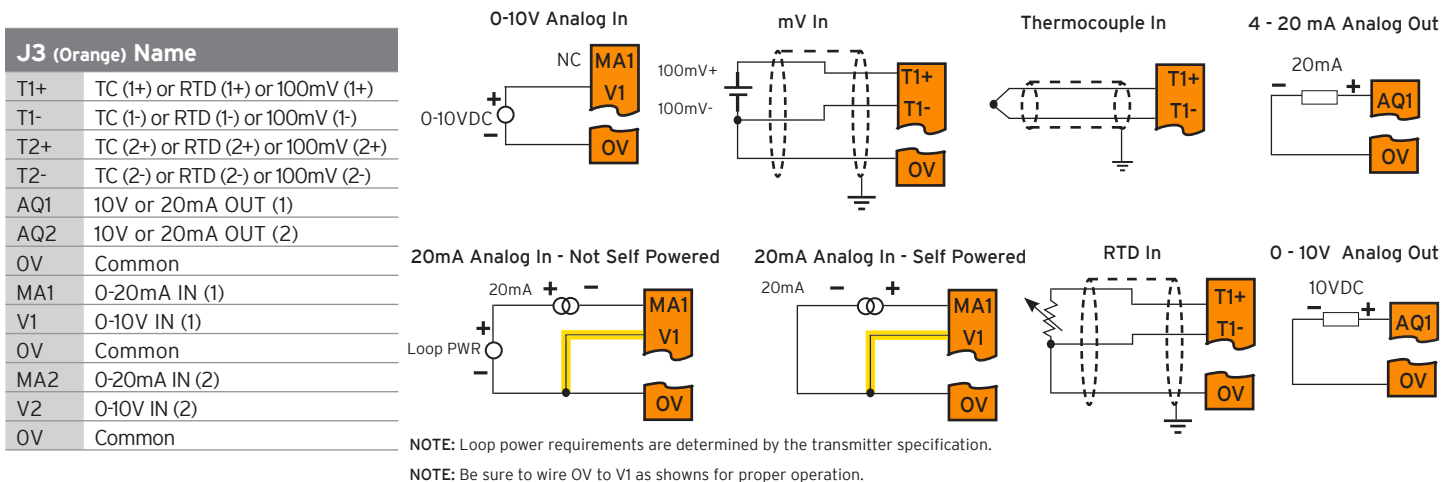

4 COMMUNICATIONS

4.1 - CAN Communications

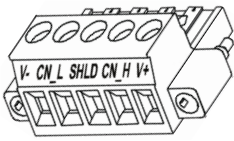

CAN Pin Assignments		
PIN	SIGNAL	DESCRIPTION
1	V-	CAN Ground - Black
2	CN L	CAN Data Low - Blue
3	SHLD	Shield Ground - None
4	CN H	CAN Data High - White
5	V+ (NC)	No Connect - Red

Solid/Stranded Wire: 12-24 awg (2.5-0.2mm).
 Strip Length: 0.28" (7mm).
 Locking spring-clamp, two-terminators per conductor.
 Torque Rating: 4.5 in-lbs (0.50 N-m).
 V+ pin is not internally connected, the SHLD pin is connected to Earth ground via a 1 MΩ resistor and 10nF capacitor.

4.2 - Serial Communications

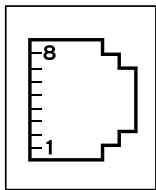

MJ1/2 SERIAL PORTS
 Two Serial Ports on One Module Jack (8posn)
MJ1: RS-232 w/Full Handshaking
MJ2: RS-232 Half-Duplex

MJ1 PINS			MJ2 PINS	
PIN	SIGNAL	DIRECTION	SIGNAL	DIRECTION
8	TXD	OUT	--	--
7	RXD	IN	--	--
6	OV	GROUND	OV	GROUND
5	+5V @ 60mA	OUT	+5V @ 60mA	OUT
4	RTS	OUT	--	--
3	CTS	IN	--	--
2	--	--	RX- / TX-	IN / OUT
1	--	--	RX+ / TX+	IN / OUT

MJ3 SERIAL PORT
 2 Multiplexed Serial Ports on One Modular Jack (8posn)

MJ3 PINS		
PIN	SIGNAL	DIRECTION
8	TXD RS232	OUT
7	RXD RS232	IN
6	OV	GROUND
5	+5V @ 60mA	OUT
4	TX- RS485	OUT
3	TX+ RS485	OUT
2	RX- RS485	IN
1	RX+ RS485-	IN

4.3 - Dip Switches

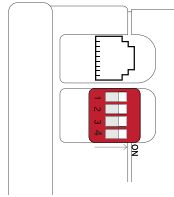

DIP SWITCHES			
PIN	NAME	FUNCTION	DEFAULT
1	MJ3 RS485 Termination	ON = Terminated	OFF
2	MJ3 Duplex	ON = Half	OFF
3		OFF = Full	OFF
4	MJ2 RS485 Termination	ON = Terminated	OFF

The DIP switches are used to provide a built-in termination to both the MJ1, MJ2 & MJ3 ports if needed. The termination for these ports should only be used if this device is located at either end of the multidrop/daisy-chained RS-485 network.

4.4 - Ethernet Communications

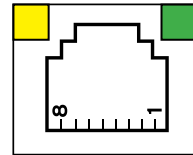

Green LED indicates link - when illuminated, data communication is available.
 Yellow LED indicates activity - when flashing, data is in transmission.

5 BUILT-IN I/O

5.1 Built-In I/O (EXL10, Model 5)

All EXL10 models (except the Model 0) feature built-in I/O. The I/O is mapped into OCS Register space, in three separate areas - digital/analog I/O, high-speed counter I/O, and high-speed output I/O. Digital/analog I/O location is fixed starting at 1, but the high-speed counter and high-speed output references may be mapped to any open register location. For more details, see the EXL10 OCS User's Manual [MAN1029].

5.2 Digital and Analog I/O Functions

Digital Inputs	%I1-24
Reserved	%I125-31
ESCP Alarm	%I32
Digital Outputs	%Q1-16
Reserved	%Q17-24
Analog Inputs	%AI1-2
Reserved	%AI3-12
Analog Outputs	%AQ9-10
Reserved	%AQ1-8

6 BATTERY MAINTENANCE

The EXL10 has an advanced battery system that uses a rechargeable lithium battery. The battery powers the real time clock when power is removed, and it is needed for register data retention. Please reference the EXL10 User Manual [MAN1029] which provides instructions on how to replace the battery.

NOTE: For detailed rechargeable battery information, refer to the Battery Manual [MAN1142].

7 DIMENSIONS & INSTALLATION

7.1 - Dimensions

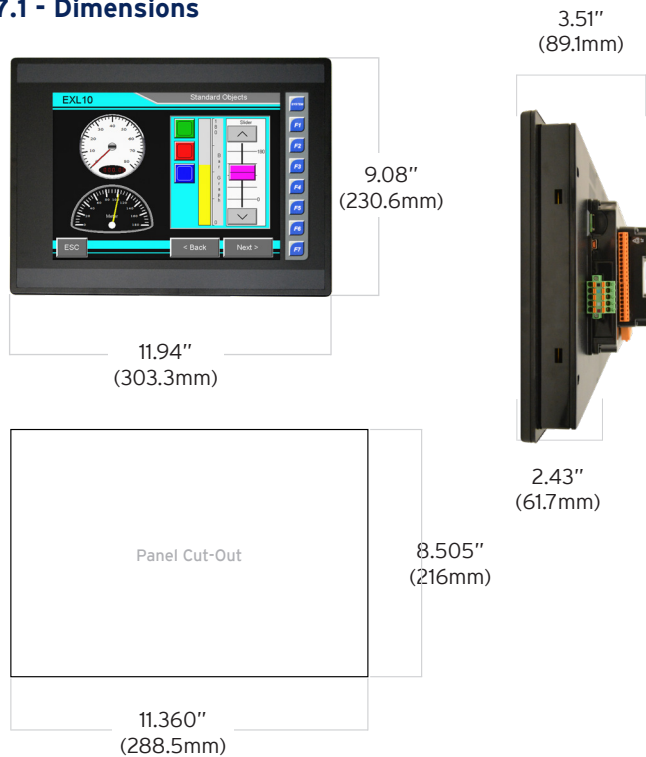

7.2 - Installation Procedure

- The EXL10 utilizes a clip installation method to ensure a robust and watertight seal to the enclosure. Please follow the steps below for the proper installation and operation of the unit.
 - This equipment is suitable for Class I, Division 2, Groups A, B, C and D or non-hazardous locations only.
 - Digital outputs shall be supplied from the same source as the operator control station.
 - Jumpers on connector JPI shall not be removed or replaced while the circuit is live unless the area is known to be free of ignitable concentrations of flammable gases or vapors.
- Carefully locate an appropriate place to mount the EXL10. Be sure to leave enough room at the top of the unit for insertion and removal of the microSD™ card.
 - Carefully cut the host panel per the diagram, creating a 216mm x 288.5mm +/-0.1 mm opening into which the EXL10 may be installed. If the opening is too large, water may leak into the enclosure, potentially damaging the unit. If the opening is too small, the OCS may not fit through the hole without damage.
 - Remove any burrs and or sharp edges and ensure the panel is not warped in the cutting process.
 - Remove all Removable Terminals from the EXL10. Insert the EXL10 through the panel cutout (from the front). The gasket must be between the host panel and the EXL10.
 - Install and tighten the four mounting clips (provided in the box) until the gasket forms a tight seal.
NOTE: Max torque is 0.8 to 1.13 N m, or 7-10 in-lbs.
 - Reinstall the EXL10 I/O Removable Terminal Blocks. Connect communications cables to the serial port, USB ports, Ethernet port, and CAN port as required.

EXL10 User Manual [MAN1029]

The User Manual includes extensive information on Built-in I/O, Common %S & %SR Registers, HSC/PWM/Totalizer/Quadrature & Accumulator Registers & Resource Limit.

page 6 of 6

8 ANALOG IN TRANZORB FAILURE

A common cause of Analog Input Tranzorb Failure on Analog Inputs Model 2, 3, 4 & 5: If a 4-20mA circuit is initially wired with loop power, but without a load, the Analog input could see 24VDC. This is higher than the rating of the tranzorb. This can be solved by NOT connecting loop power prior to load connection, or by installing a low-cost PTC in series between the load and analog input.

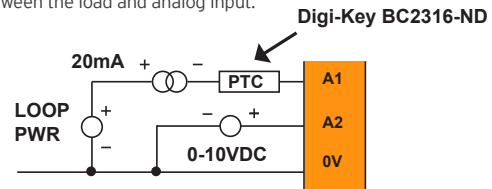

9 SAFETY & WARNINGS

9.1 - WARNINGS

- To avoid the risk of electric shock or burns, always connect the safety (or earth) ground before making any other connections.
- To reduce the risk of fire, electrical shock, or physical injury, it is strongly recommended to fuse the voltage measurement inputs. Be sure to locate fuses as close to the source as possible.
- Replace fuse with the same type and rating to provide protection against risk of fire and shock hazards.
- In the event of repeated failure, do NOT replace the fuse again as repeated failure indicates a defective condition that will NOT clear by replacing the fuse.
- Only qualified electrical personnel familiar with the construction and operation of this equipment and the hazards involved should install, adjust, operate, or service this equipment. Read and understand this manual and other applicable manuals in their entirety before proceeding. Failure to observe this precaution could result in severe bodily injury or loss of life.
- WARNING - Battery may explode if mistreated.** Do not recharge, disassemble, or dispose of in fire.
- WARNING - EXPLOSION HAZARD - Batteries must only be changed in an area known to be non-hazardous.**

9.2 - FCC COMPLIANCE

This device complies with Part 15 of the FCC Rules. Operation is subject to the following two conditions:

- This device may not cause harmful interference
- This device must accept any interference received, including interference that may cause undesired operation

9.3 - PRECAUTIONS

All applicable codes and standards need to be followed in the installation of this product. Adhere to the following safety precautions whenever any type of connection is made to the module:

- Connect the safety (earth) ground on the power connector first before making any other connections.
- When connecting to the electric circuits or pulse-initiating equipment, open their related breakers.
- Do NOT make connection to live power lines.
- Make connections to the module first; then connect to the circuit to be monitored.
- Route power wires in a safe manner in accordance with good practice and local codes.
- Wear proper personal protective equipment including safety glasses and insulated gloves when making connections to power circuits.
- Ensure hands, shoes, and floor are dry before making any connection to a power line.
- Make sure the unit is turned OFF before making connection to terminals.
- Make sure all circuits are de-energized before making connections.
- Before each use, inspect all cables for breaks or cracks in the insulation. Replace immediately if defective.
- Use copper conductors in Field Wiring only, 60/75°C.
- Use caution when connecting controllers to PCs via serial or USB. PCs, especially laptops may use "floating power supplies" that are ungrounded. This could cause a damaging voltage potential between the laptop and controller. Ensure the controller and laptop are grounded for maximum protection. Consider using a USB isolator due to voltage potential differences as a preventative measure.

10 PART NUMBER

	Global	European
Model 5	HE-EXV1E5	HEXT505C115

11 TECHNICAL SUPPORT

For assistance and manual updates, contact Technical Support at the following locations:

North America
(317) 916-4274
www.hornerautomation.com
techsppt@heapg.com

Europe
(+) 353-21-4321-266
www.hornerautomation.eu
technical.support@horner-apg.com