



XL4 OCS DATASHEET

MODEL 4
24 DC In, 16 DC Out, 2 - 12-bit Analog In

1 TECHNICAL SPECIFICATIONS

1.1 General

Typical Power-Backlight 100%	276mA @ 10V (2.76W), 171mA @ 24V (4.10W)
Power Backlight Off	-24mA @ 24VDC (0.58W)
Power Backlight @ 50%	-18mA @ 24VDC (0.43W)
Required Power (Steady State)	171mA @ 24VDC (1.71W) 276mA @ 10 VDC (2.76W)
Heater Option	250mA with heater operating (24VDC) *Heater Option (Model# plus "-22")
Required Power (Inrush)	2A for < 1ms @ 24VDC, DC switched
Primary Power Range	10 - 30VDC 10 - 24VDC (with heater option)
Relative Humidity	5 to 95% non-condensing
Real Time Clock	Battery Backed, Rechargeable Lithium
Clock Accuracy	+ / - 20 ppm maximum at 25°C (+/- 2 min/month)
Operating Temperature	-10°C to +60°C (-22 Heater Option range is -40°C to +60°C)
Storage Temperature	-20°C to +60°C
Weight	12 oz / 340g (without I/O)
Altitude	Up to 2000m
Rated Pollution Degree	Evaluated for Pollution Degree 2 Rating
Certifications (UL/CE)	North America Europe

1.2 User Interface

Display Type	3.5" TFT Color
Screen Brightness	640cd/m ² (nits)
Resolution	QVGA (320 x 240)
Color	16-bit (65,535)
User-Program. Screens	1023 max pages; 1023 objects per page
Backlight	LED - 50,000 hour life
Brightness Control	0-100% via System Register %SR57
Screen Update Rate	User configurable within the scan time
Number of Keys	5

1.3 Connectivity

Serial Ports	1 RS-232 and 1 RS-485 on singular Modular Jack (MJI)
USB mini-B	USB 2.0 (480MHz) Programming & Data Access
USB A (500mA max)	USB 2.0 (480MHz) for USB flash drives (2TB)
CAN Port Isolated 1 kV	Remote I/O, Peer-to-peer Comms, Cscope
CAN Protocols	CsCAN, CANopen, DeviceNet, J1939
Ethernet	10/100 Mb (Auto-MDX)
Ethernet Protocols	TCP/IP, Modbus TCP, FTP, SRTP, EGD, ICMP, ASCII
Remote I/O	SmartRail, SmartStix, SmartBlock, SmartMod
Removable Memory	microSD, SDHC, SDXC IN FAT32 format, support for 32GB max. Application Updates, Datalogging, and more

1.4 Control & Logic

Control Language Support	Advanced Ladder Logic Full IEC 61131-3 Languages
Logic Program Size	1 MB, maximum
Logic Scan Rate	0.013ms/kB
Digital Inputs	2048
Digital Outputs	2048
Analog Inputs	512
Analog Outputs	512
Gen. Purpose Registers	50,000 (words) Retentive 16,384 (bits) Retentive 16,384 (bits) Non-retentive

1.5 High-Speed Inputs

Number of Counters	4
Maximum Frequency	1MHz each
Accumulator Size	32-bits each
Modes Supported	Totalizer, quadrature, pulse measurement, frequency measurement, set-point controlled outputs

1.6 High-Speed Outputs

Modes Supported	Stepper, PWM
Output Frequency	500kHz

technical specifications continued...

1.7 Digital DC Inputs

Inputs per Module	24 Including 4 Configurable HSC Inputs	
Commons per Module	1	
Input Voltage Range	12VDC / 24VDC	
Absolute Max. Voltage	30VDC Max.	
Input Impedance	10kΩ	
Input Current	Positive Logic	Negative Logic
Upper Threshold	0.8mA	-1.6mA
Lower Threshold	0.3mA	-2.1mA
Max. Upper Threshold	8VDC	
Min. Lower Threshold	3VDC	
OFF to ON Response	1ms	
ON to OFF Response	1ms	
High Speed Counter Max Freq*	1MHz	

*See I/O info below for detail regarding HSC and PWM

1.8 Digital DC Outputs

Outputs per Module	16 Including 2 Configurable PWM Outputs
Commons per Module	1
Output Type	Sourcing / 10kΩ Pull-Down
Output Frequency	500kHz
Absolute Max. Voltage	28VDC Max.
Output Protection	Short Circuit
Max. Output Current/Point	0.5A
Max. Total Current	4A Continuous
Max. Output Supply Voltage	30VDC
Min. Output Supply Voltage	10VDC
Max. Voltage Drop at Rated Current	0.25VDC
Max. Inrush Current	650mA per Channel
Min. Load	None
OFF to ON Response	1ms
ON to OFF Response	1ms
Output Characteristics	Current Sourcing (Pos. Logic)
PWM Out	≈ 5kHz
Rise Time	50 - 115μs
Fall Time	8-20μs

1.9 Analog Inputs

Number of Channels	2
Input Ranges	0 - 10VDC 0 - 20mA 4 - 20mA
Safe Input Range	-0.5V to +12V
Input Impedance (Clamped @ -0.5 VDC to 12 VDC)	Current Mode: 100Ω Voltage Mode: 500kΩ
Nominal Resolution	12 Bits
%AI full scale	0V, 20mA, 100mV: 32,000 counts full scale
Max. Over-Current	35mA
Conversion Speed	All channels converted once per ladder scan
Max. Error @25°C (excluding zero)	4-20mA 1.00% 0-20mA 1.00% 0-10VDC 0.50%
Filtering	160Hz hash (noise) filter 1128 scan digital running average filter

2 CONTROLLER OVERVIEW

2.1 - Port Connectors



NOTE: See Precaution #12 on page 6 about USB and grounding.

2.2 - Power Wiring

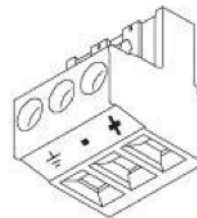

DC Input / Frame

Solid/Stranded Wire: 12-24 awg (2.5-0.2mm).
Strip Length: 0.28" (7mm).
Torque Rating: 4.5 - 7 in-lbs (0.50 - 0.78 N-m).
DC- is internally connected to I/O V-, but is isolated from CAN V-.
A Class 2 power supply must be used.

POWER UP

1. Attach included ferrite core with a minimum of two turns of the DC+ and DC- signals from the DC supply that is powering the controller.
2. Connect to Earth Ground
3. Apply recommended power.



Primary Power Port Pins

PIN	SIGNAL	DESCRIPTION
1	Ground	Frame Ground
2	DC-	Input Power Supply Ground
3	DC+	Input Power Supply Voltage

3 WIRING: INPUTS AND OUTPUTS

3.1 - Digital Input & Output Information

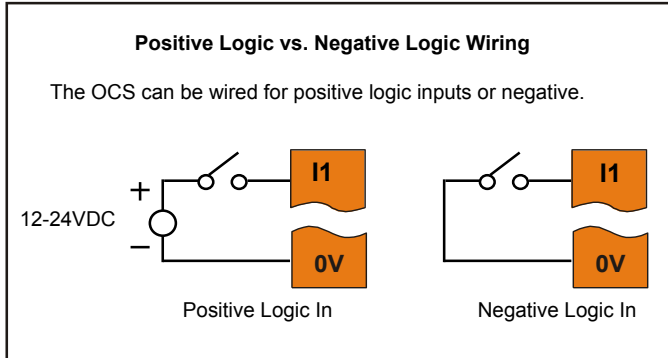

Digital inputs may be wired in either a Positive Logic or Negative Logic fashion as shown. The setting in the Cscape Hardware Configuration for the Digital Inputs must match the wiring used in order for the correct input states to be registered. No jumper settings are required for XL4. When used as a normal input and not for high speed functions, the state of the input is reflected in registers %I1 - %I12.

Digital inputs may alternately be specified for use with High Speed Counter functions, also found in the Hardware Configuration for Digital Inputs. Refer to the XL4 User Manual [MAN0964] for full details.

3.2 - Analog Input Information

Raw input values for channels 1 - 2 are found in the registers as Integer-type data with a range from 0 - 32000.

Analog inputs may be filtered digitally with the Filter Constant found in the Cscape Hardware Configuration for Analog Inputs. Valid filter values are 0 - 7 and act according to the following chart.

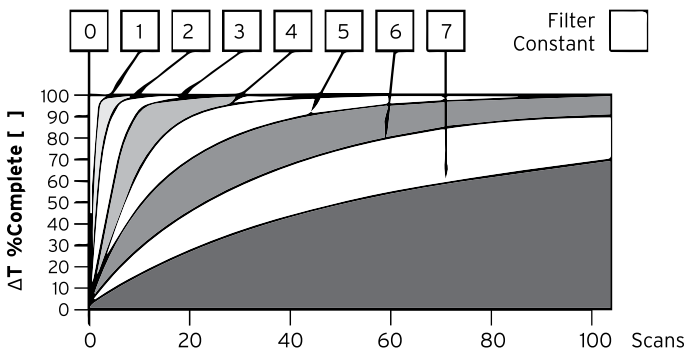

Data Values	
INPUT MODE:	DATA FORMAT, 12-bit INT:
0-20mA, 4-20mA	0-32000
0-10V	0-32000

3.3 - Jumper Setting Details

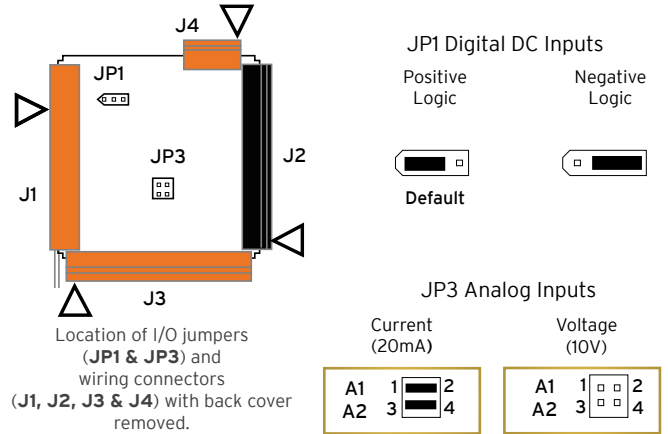

NOTE: The Cscape Module Configuration must match the selected I/O (JP) jumper settings. Cscape Path: **Controller > Hardware Configuration > Local I/O > Config > Module Setup > Analog In**

NOTE: When using JP3 (A1-A2), each channel can be independently configured.

Back Panel Torque Rating for XL4: 3.5 - 4.0 in-lbs (0.40 - 0.45 N-m)

3.4 - Wiring Connectors

J1 - Orange - Digital In / Analog In

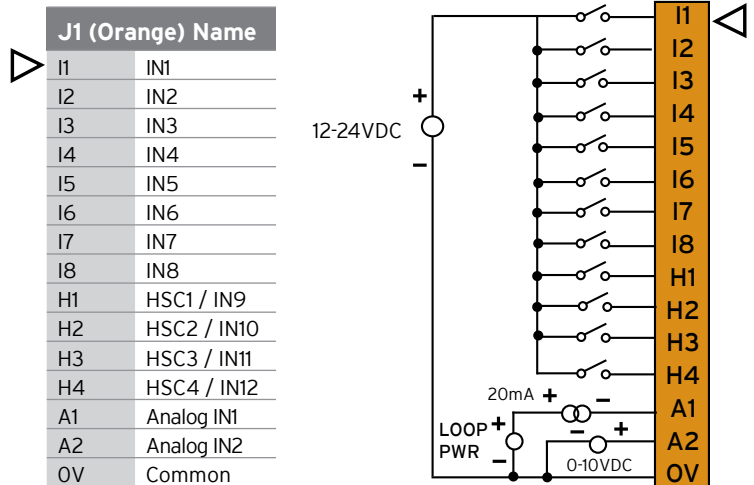

20mA Analog In - Not Self Powered

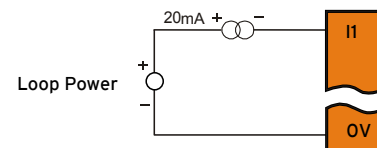

20mA Analog In - Self Powered

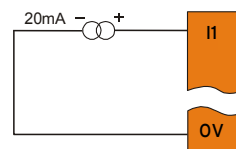

0-10VDC IN

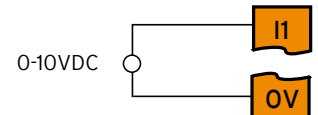

wiring: I-O continued on next page...

wiring: I-O continued...

J2 - Black - Relay Out / Digital In

J2 (Black) Name	
OV	Common
V+	V+
NC	No Connect
Q12	OUT 12
Q11	OUT 11
Q10	OUT 10
Q9	OUT 9
Q8	OUT 8
Q7	OUT 7
Q6	OUT 6
Q5	OUT 5
Q4	OUT 4
Q3	OUT 3
Q2	OUT2/PWM2
Q1	OUT1/PWM1

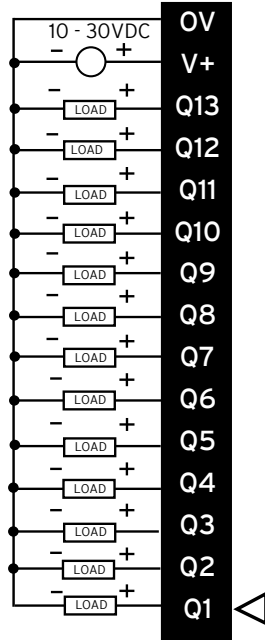

J4 - Orange

Positive Logic / Digital Out

J4 (Orange) Name	
Q16	OUT16
Q15	OUT15
Q14	OUT14

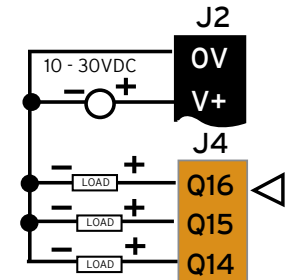

4 COMMUNICATIONS

4.1 - CAN Communications

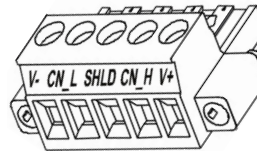

CAN Pin Assignments

PIN	SIGNAL	DESCRIPTION
1	V-	CAN Ground - Black
2	CN L	CAN Data Low - Blue
3	SHLD	Shield Ground - None
4	CN H	CAN Data High - White
5	V+ (NC)	No Connect - Red

CAN

Solid/Stranded Wire: 12-24 awg (2.5-0.2mm).

Strip Length: 0.28" (7mm).

Locking spring-clamp, two-terminators per conductor.

Torque, Terminal Hold-Down Screws: 4.5 - 7 in-lbs (0.50 - 0.78 N-m).

V+ pin is not internally connected, the SHLD pin is connected to Earth ground via a 1MΩ resistor and 10 nF capacitor.

4.2 - Ethernet Communications

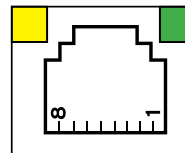

Green LED indicates link - when illuminated, data communication is available.

Yellow LED indicates activity - when flashing, data is in transmission.

J3 - Orange - Positive Logic / Digital In

J3 (Orange) Name

I13	IN13
I14	IN14
I15	IN15
I16	IN16
I17	IN17
I18	IN18
I19	IN19
I20	IN20
I21	IN21
I22	IN22
I23	IN23
I24	IN24
OV	Common

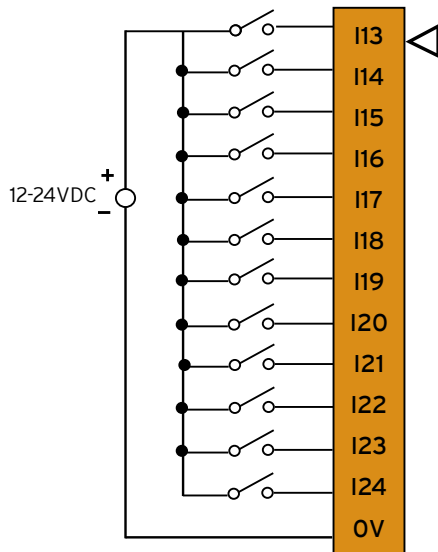

Wiring Details:

Solid/Stranded Wire: 12-24 awg (2.5-0.2mm²).

Strip Length: 0.28" (7mm).

Torque, Terminal Hold-Down Screws: 4.5 - 7 in-lbs (0.50 - 0.78 N-m).

communications continued...

5 BUILT-IN I/O for Model 4

4.3 - Serial Communications

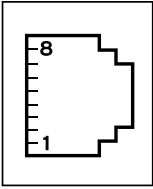

MJ1/2 SERIAL PORTS

Two Serial Ports on One Module Jack (8posn)

MJ1: RS-232 w/Full Handshaking

MJ2: RS-485 Half-Duplex

All XL4 models (except the Model 0) feature built-in I/O. The I/O is mapped into OCS Register space, in three separate areas - Digital/Analog I/O, High-Speed Counter I/O, and High-Speed Output I/O. Digital/Analog I/O location is fixed starting at 1, but the high-speed counter and high-speed output references may be mapped to any open register location. For more details, see the XL4 OCS User's Manual [MAN0964].

Digital and Analog I/O Functions	
Digital Inputs	%I1-24
Reserved	%I25-31
ESCP Alarm	%I32
Digital Outputs	%Q1-16
Reserved	%Q17-24
Analog Inputs	%A11-2
Reserved	%A13-12
Analog Outputs	n/a
Reserved	%AQ1-8

MJ1 PINS			MJ2 PINS	
PIN	SIGNAL	DIRECTION	SIGNAL	DIRECTION
8	TXD	OUT	--	--
7	RXD	IN	--	--
6	0V	GROUND	0V	GROUND
5	+5V @ 60mA	OUT	+5V @ 60mA	OUT
4	RTS	OUT	--	--
3	CTS	IN	--	--
2	--	--	RX- / TX-	IN / OUT
1	--	--	RX+ / TX+	IN / OUT

Attach optional ferrite core with a minimum of two turns of serial cable. See website for more details. [Part #: HE-FBD001]

6 ANALOG IN TRANZORB FAILURE

A common cause of Analog Input Tranzorb Failure on Analog Inputs Model 2, 3, 4 & 5: If a 4- 20mA circuit is initially wired with loop power, but without a load, the Analog input could see 24VDC. This is higher than the rating of the tranzorb. This can be solved by NOT connecting loop power prior to load connection, or by installing a low-cost PTC in series between the load and analog input.

4.4 - Dip Switches

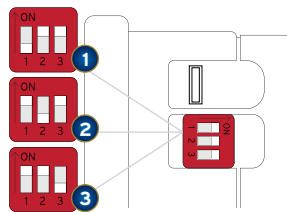

The DIP switches are used to provide a built-in termination to the MJ2 port if needed. The termination for these ports should only be used if this device is located at either end of the multidrop/daisy-chained RS-485 network.

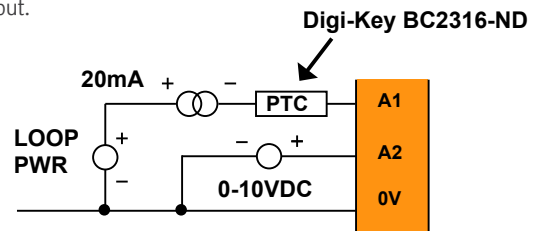

DIP SWITCHES			
PIN	NAME	FUNCTION	DEFAULT
1	MJ1 RS-485 Termination	ON = Terminated	OFF
2	Spare	Always OFF	OFF
3	Factory Use	Always OFF	OFF

7 DIMENSIONS & INSTALLATION

7.1 - Dimensions

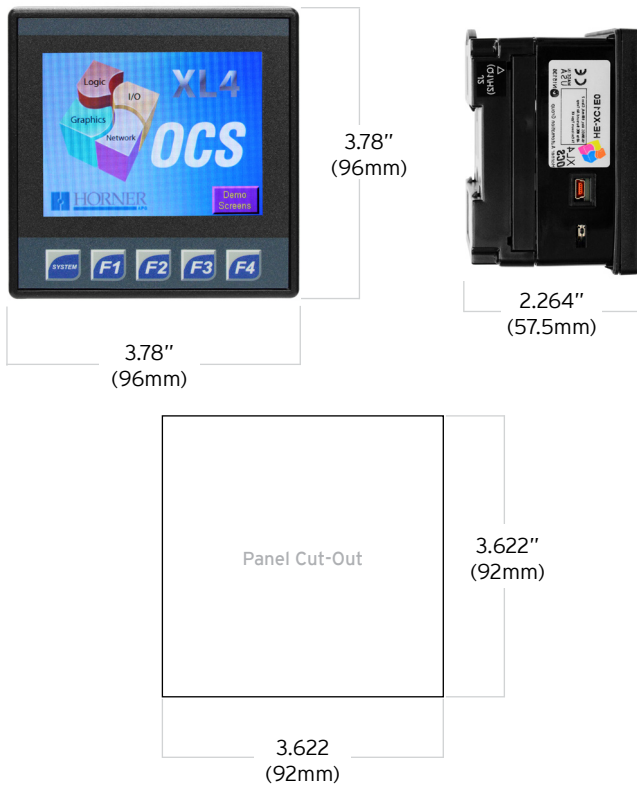

* +/- 0.1mm cutout tolerance

7.2 - Installation Procedure

- The XL4 utilizes a clip installation method to ensure a robust and watertight seal to the enclosure. Please follow the steps below for the proper installation and operation of the unit.
 - This equipment is suitable for Class I, Division 2, Groups A, B, C and D or non-hazardous locations only.
 - Digital outputs shall be supplied from the same source as the operator control station.
 - Jumpers on connector JP1 shall not be removed or replaced while the circuit is live unless the area is known to be free of ignitable concentrations of flammable gases or vapors.
1. Carefully locate an appropriate place to mount the XL4. Be sure to leave enough room at the top of the unit for insertion and removal of the microSD™ card.
 2. Carefully cut the host panel per the diagram, creating a 92mm x 92mm +/-0.1mm opening into which the XL4 may be installed. If the opening is too large, water may leak into the enclosure, potentially damaging the unit. If the opening is too small, the OCS may not fit through the hole without damage.
 3. Remove any burrs and or sharp edges and ensure the panel is not warped in the cutting process.
 4. Remove all Removable Terminals from the XL4. Insert the XL4 through the panel cutout (from the front). The gasket must be between the host panel and the XL4.
 5. Install and tighten the four mounting clips (provided in the box) until the gasket forms a tight seal
NOTE: Max torque is 0.8 to 1.13Nm, 7 to 10 in-lbs.
 6. Reinstall the XL4 I/O Removable Terminal Blocks. Connect communications cables to the serial port, USB ports, Ethernet port, and CAN port as required.

XL4 User Manual [MAN0964]

The User Manual includes extensive information on:

- Built-in I/O
- Common %S & %SR Registers
- HSC/PWM/Totalizer/Quadrature & Accumulator Registers
- Resource Limits

8 SAFETY

8.1 - WARNINGS

1. To avoid the risk of electric shock or burns, always connect the safety (or earth) ground before making any other connections.
2. To reduce the risk of fire, electrical shock, or physical injury, it is strongly recommended to fuse the voltage measurement inputs. Be sure to locate fuses as close to the source as possible.
3. Replace fuse with the same type and rating to provide protection against risk of fire and shock hazards.
4. In the event of repeated failure, do NOT replace the fuse again as repeated failure indicates a defective condition that will NOT clear by replacing the fuse.
5. Only qualified electrical personnel familiar with the construction and operation of this equipment and the hazards involved should install, adjust, operate, or service this equipment. Read and understand this manual and other applicable manuals in their entirety before proceeding. Failure to observe this precaution could result in severe bodily injury or loss of life.
6. **WARNING** - Battery may explode if mistreated. Do not recharge, disassemble, or dispose of in fire.
7. **WARNING - EXPLOSION HAZARD** - Batteries must only be changed in an area known to be non-hazardous.

8.2 - FCC COMPLIANCE

This device complies with Part 15 of the FCC Rules. Operation is subject to the following two conditions:

1. This device may not cause harmful interference
2. This device must accept any interference received, including interference that may cause undesired operation

8.3 - PRECAUTIONS

All applicable codes and standards need to be followed in the installation of this product. Adhere to the following safety precautions whenever any type of connection is made to the module:

1. Connect the safety (earth) ground on the power connector first before making any other connections.
2. When connecting to the electric circuits or pulse-initiating equipment, open their related breakers.
3. Do NOT make connection to live power lines.
4. Make connections to the module first; then connect to the circuit to be monitored.
5. Route power wires in a safe manner in accordance with good practice and local codes.
6. Wear proper personal protective equipment including safety glasses and insulated gloves when making connections to power circuits.
7. Ensure hands, shoes, and floor are dry before making any connection to a power line.
8. Make sure the unit is turned OFF before making connection to terminals.
9. Make sure all circuits are de-energized before making connections.
10. Before each use, inspect all cables for breaks or cracks in the insulation. Replace immediately if defective.
11. Use copper conductors in Field Wiring only, 60/75°C.
12. Use caution when connecting controllers to PCs via serial or USB. PCs, especially laptops may use "floating power supplies" that are ungrounded. This could cause a damaging voltage potential between the laptop and controller. Ensure the controller and laptop are grounded for maximum protection. Consider using a USB isolator due to voltage potential differences as a preventative measure.

9 BATTERY MAINTENANCE

The XL4 has an advanced battery system that uses a rechargeable lithium battery. The battery powers the real time clock when power is removed, and it is needed for register data retention. Please reference the XL4 User Manual [MAN0964] which provides instructions on how to replace the battery.

NOTE: For detailed rechargeable battery information, refer to the Battery Manual [MAN1142].

10 ACCESSORIES

10.1 Backup Battery: HE-BAT00019

The XL4 uses rechargeable 3.6V lithium battery to run the Real-Time Clock and to maintain the retained register values. This battery is designed to maintain the clock and memory for 7-10 years.

10.2 Programming Cables Kit: HE-XCK

This programming cable kit includes the following adapter cables:

- USB to MiniUSB
- USB to RS-232 Serial
- RS-232 Serial to RJ45 Ethernet

10.3 2/4 Channel Analog Output Kit

- HE-XDAC007 - 2 Channel Analog Output I/O Kit
- HE-XDAC107 - 4 Channel Analog Output I/O Kit

Visit the Horner Website to purchase accessories.

11 PART NUMBER

	Global	European
Model 4	HE-XC1E4	HEXT251C114

12 TECHNICAL SUPPORT

For assistance and manual updates, contact Technical Support at the following locations:

North America

+1 (317) 916-4274
 (877) 665-5666
www.hornerautomation.com
 techsppt@heapg.com

Europe

+353 (21) 4321-266
www.hornerautomation.eu
 technical.support@horner-apg.com