

# XL4 OCS DATASHEET



**MODEL 2**  
12 DC In, 6 Relay Out, 4 - 12-bit Analog In

## 1 TECHNICAL SPECIFICATIONS

### 1.1 General

|                               |   |
|-------------------------------|---|
| Typical Power-Backlight 100%  | 370mA @ 10V (3.70W), 160mA @ 24V (3.84W)                                  |
| Power Backlight Off           | -24mA @ 24VDC (0.58W)   |
| Power Backlight @ 50%         | -18mA @ 24VDC (0.43W)   |
| Required Power (Steady State) | 160mA @ 24VDC (1.6W)<br>370mA @ 10VDC (3.7W)                              |
| Heater Option                 | 250mA with heater operating (24VDC)<br>*Heater Option (Model# plus "-22") |
| Required Power (Inrush)       | 2A for < 1ms @ 24 VDC, DC switched  |
| Primary Power Range           | 10 - 30VDC<br>10 - 24VDC (with heater option)                             |
| Relative Humidity             | 5 to 95%, Non-Condensing  |
| Real Time Clock               | Battery Backed, Rechargeable Lithium                                      |
| Clock Accuracy                | + / - 20 ppm maximum at 25°C<br>(+/- 1 min/month)                         |
| Operating Temperature         | -10°C to +60°C (-22 Heater Option range is<br>-40°C to +60°C)             |
| Storage Temperature           | -20°C to +60°C  |
| Weight                        | 12 oz / 340g (without I/O)  |
| Altitude                      | Up to 2000m   |
| Rated Pollution Degree        | Evaluated for Pollution Degree 2 Rating                                   |
| Certifications (UL/CE)        | <a href="#">North America</a><br><a href="#">Europe</a>                   |

### 1.4 User Interface

|                       |  |
|-----------------------|--|
| Display Type          | 3.5" TFT Color                         |
| Screen Brightness     | 640cd/m <sup>2</sup> (nits)            |
| Resolution            | QVGA (320 x 240)                       |
| Color                 | 16-bit (65,535)                        |
| User-Program. Screens | 1023 max pages; 1023 objects per page  |
| Backlight             | LED - 50,000 hour life                 |
| Brightness Control    | 0-100% via System Register %SR57       |
| Screen Update Rate    | User Configurable within the scan time |
| Number of Keys        | 5                                      |

### 1.2 Connectivity

|                        |  |
|------------------------|--|
| Serial Ports           | 1 RS-232 and 1 RS-485 on singular Modular Jack (MJ1)   |
| USB mini-B             | USB 2.0 (480MHz) Programming & Data Access   |
| USB A (500mA max)      | USB 2.0 (480 MHz) for USB flash drives (2TB)   |
| CAN Port Isolated 1 kV | Remote I/O, Peer-to-peer Comms, Cscape   |
| CAN Protocols          | CsCAN, CANopen, DeviceNet, J1939   |
| Ethernet               | 10/100Mb (Auto-MDX)  |
| Ethernet Protocols     | TCP/IP, Modbus TCP, FTP, SRTP, EGD, ICMP, ASCII  |
| Remote I/O             | SmartRail, SmartStix, SmartBlock, SmartMod   |
| Removable Memory       | microSD, SDHC, SDXC IN FAT32 format, support for 32 GB max. Application Updates, Datalogging, and more |

### 1.3 Control & Logic

|                          |  |
|--------------------------|--|
| Control Language Support | Advanced Ladder Logic Full IEC 61131-3 Languages                                   |
| Logic Program Size       | 1MB, maximum   |
| Logic Scan Rate          | 0.013ms/kB   |
| Digital Inputs           | 2048   |
| Digital Outputs          | 2048   |
| Analog Inputs            | 512  |
| Analog Outputs           | 512  |
| Gen. Purpose Registers   | 50,000 (words) Retentive<br>16,384 (bits) Retentive<br>16,384 (bits) Non-retentive |

### 1.5 High-Speed Inputs

|                    |   |
|--------------------|---|
| Number of Counters | 4   |
| Maximum Frequency  | 1MHz Max  |
| Accumulator Size   | 32-bits each  |
| Modes Supported    | Totalizer, quadrature, pulse measurement, frequency measurement, set-point controlled outputs |

### XL4 User Manual [MAN0964]

The User Manual includes extensive information on:

- Common %S & %SR Registers
- Resource Limits

## technical specifications continued...

### 1.6 Digital DC Inputs

|                              |  |                       |
|------------------------------|--|-----------------------|
| Inputs per Module            | 12 including 4 configurable HSC inputs |                       |
| Commons per Module           | 1                                      |                       |
| Input Voltage Range          | 12VDC / 24VDC                          |                       |
| Absolute Max. Voltage        | 30VDC Max.                             |                       |
| Input Impedance              | 10kΩ                                   |                       |
| <b>Input Current</b>         | <b>Positive Logic</b>                  | <b>Negative Logic</b> |
| Upper Threshold              | 0.8mA                                  | -1.6mA                |
| Lower Threshold              | 0.3mA                                  | -2.1mA                |
| Max. Upper Threshold         | 8VDC                                   |                       |
| Min. Lower Threshold         | 3VDC                                   |                       |
| OFF to ON Response           | 1ms                                    |                       |
| ON to OFF Response           | 1ms                                    |                       |
| High Speed Counter Max Freq* | 1MHz                                   |                       |

### 1.7 Digital Relay Outputs

|   |  |
|---|--|
| Outputs per Module                                  | 6 Relay                                    |
| Commons per Module                                  | 6  |
| Max. Output Current per Relay                       | 3A @ 250VAC, resistive                     |
| Max. Total Output Current                           | 5A continuous                              |
| Max. Output Voltage                                 | 275VAC, 30 VDC                             |
| Max. Switched Power                                 | 1000VAC, 150W                              |
| Contact Isolation to Ground                         | 1000VAC                                    |
| Max. Voltage Drop at Related Current                | 0.5V                                       |
| Expected Life (see below derating chart for detail) | No Load: 5,000,000<br>Rated Load: 100,000  |
| Max. Switching Rate                                 | 300 CPM at no load<br>20 CPM at rated load |
| Type  | Mechanical Contact                         |
| Response Time                                       | One update per ladder scan plus 10ms       |

### 1.8 Analog Inputs, Medium Resolution

|  |  |
|--|--|
| Number of Channels   | 4  |
| Input Ranges   | 0-10VDC, 0-20mA, 4-20mA  |
| Safe Input Voltage Range   | -0.5V to 12V   |
| Input Impedance (clamped @ -0.5 VDC to 12 VDC)                     | Current Mode: 100Ω<br>Voltage Mode: 500kΩ                            |
| Nominal Resolution   | 12 Bits  |
| %AI Full Scale   | 0V, 20mA, 100mV: 32,000 counts full scale                            |
| Max. Over Current  | 35mA   |
| Conversion Speed   | Once per Ladder Scan   |
| Max Error at 25°C (excluding Zero) Adjusting Filtering may Tighten | 4-20mA 1.00%<br>0-20mA 1.00%<br>0-10VDC 1.50%                        |
| Filtering  | 160Hz Hash (noise) Filter, 1-128 Scan Digital Running Average Filter |

\*See I/O info below for detail regarding HSC and PWM

## 2 CONTROLLER OVERVIEW

### 2.1 - Overview of XL4



1. Touchscreen
2. Function Keys
3. High Capacity microSD Slot
4. Configuration Switches
5. USB Mini-B Port
6. Wide-Range DC Power
7. CAN Port
8. Ethernet LAN Port
9. USB A Port
10. RS232/RS485 Serial Port

NOTE: See Precaution #12 on page 6 about USB and grounding.

### 2.2 - Power Wiring

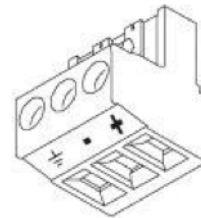

#### Primary Power Port Pins

| PIN | SIGNAL | DESCRIPTION                |
|-----|--------|----------------------------|
| 1   | Ground | Frame Ground               |
| 2   | DC-    | Input Power Supply Ground  |
| 3   | DC+    | Input Power Supply Voltage |

#### DC Input / Frame

Solid/Stranded Wire: 12-24 awg (2.5-0.2mm).

Strip length: 0.28" (7mm).

Torque, Terminal Hold-Down Screws: 4.5 - 7 in-lbs (0.50 - 0.78 N-m).

DC- is internally connected to I/O V-, but is isolated from CAN V-.

A Class 2 power supply must be used.

#### POWER UP

1. OPTION: Attach ferrite core with a minimum of two turns of the DC+ and DC- signals from the DC supply that is powering the controllers.
2. Connect to earth ground.
3. Apply recommended power.



### 3 WIRING: INPUTS & OUTPUTS

#### 3.1 - Analog Input

Raw input values for channels 1 - 2 are found in the registers as Integer-type data with a range from 0 - 32000.

Analog inputs may be filtered digitally with the Filter Constant found in the Cscape Hardware Configuration for Analog Inputs. Valid filter values are 0 - 7 and act according to the following chart.

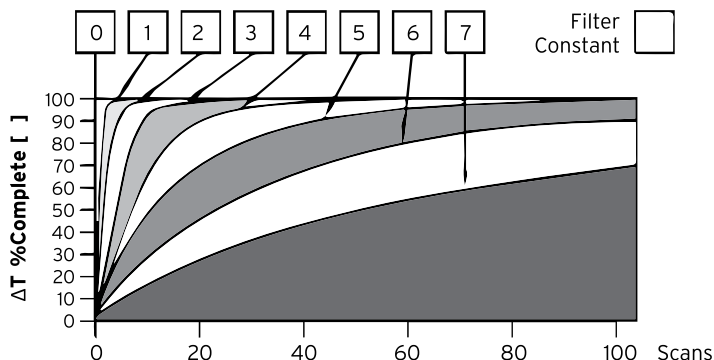

| Data Values    |                          |
|----------------|--------------------------|
| INPUT MODE:    | DATA FORMAT, 12-bit INT: |
| 0-20mA, 4-20mA | 0-32000                  |
| 0-10V          | 0-32000                  |

#### 3.2 - Digital Input

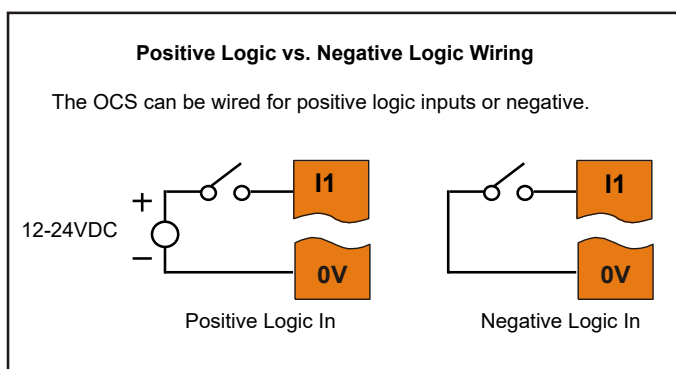

Digital inputs may be wired in either a Positive Logic or Negative Logic fashion as shown. The setting in the Cscape Hardware Configuration for the Digital Inputs must match the wiring used in order for the correct input states to be registered. When used as a normal input and not for high speed functions, the state of the input is reflected in registers %I1 - %I12.

Digital inputs may alternately be specified for use with High Speed Counter functions, also found in the Hardware Configuration for Digital Inputs. Refer to the XL4 User Manual [MANO964] for full details.

#### 3.3 - Relay Out

##### Relay Life Expectancy

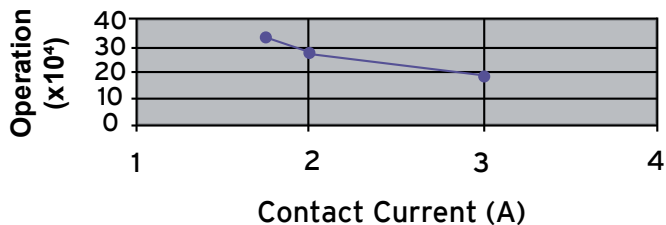

**WARNING:** Exposure to some chemicals may degrade the sealing properties of materials used in the Tyco relay PCJ.

Cover/Case & Base: Mitsubishi engineering Plastics Corp.  
5010GN6-30 or 5010GN6-30 M8 (PBT)

Sealing Material: Kishimoto 4616-50K (1 part epoxy resin)

It is recommended to periodically inspect the relay for any degradation of properties and replace if necessary.

#### 3.4 - Jumper Settings for Model 2

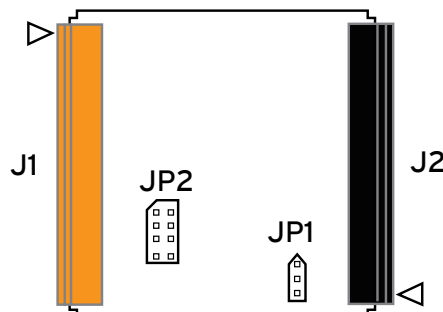

Location of I/O jumpers (JP1 & JP2) and wiring connectors (J1 & J2) with back cover removed.

##### JP1 Digital DC IN/ HSC

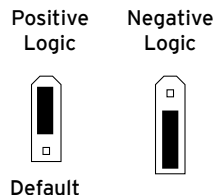

##### JP2 Analog In (A1 - A4)

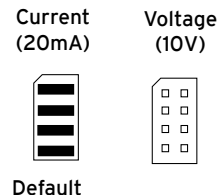

**NOTE:** The Cscape Module Configuration must match the selected I/O (JP) jumper settings.  
(Cscape Path: Controller -> Hardware Configuration -> Local I/O -> Config -> Module Setup -> Analog In)

**NOTE:** When using JP2 (A1-A4), each channel can be independently configured.

**Back Panel Torque Rating for XL4e:** 3.5 - 4.0 in-lbs (0.40 - 0.45 N-m)

## wiring: I-O continued...

### 3.5 - Wiring Connectors

#### Digital In / Analog In J1 Wiring

| J1 (Orange) Name | Name       |
|------------------|------------|
| I1               | IN1        |
| I2               | IN2        |
| I3               | IN3        |
| I4               | IN4        |
| I5               | IN5        |
| I6               | IN6        |
| I7               | IN7        |
| I8               | IN8        |
| H1               | HSC1 / IN9 |
| OV               | Common     |
| A1               | Analog IN1 |
| A2               | Analog IN2 |
| A3               | Analog IN3 |
| A4               | Analog IN4 |
| OV               | Common     |

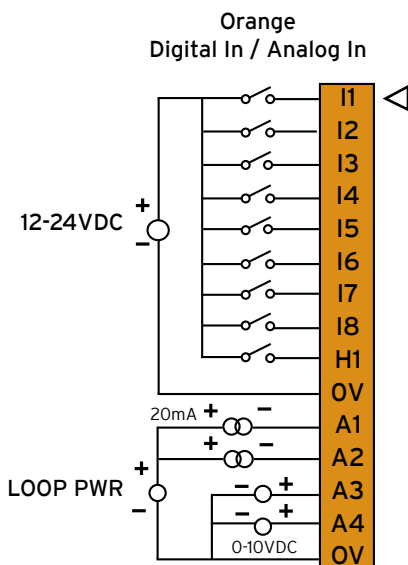

NOTE: The OV terminals are internally connected.

#### Relay Out / Analog Digital In J2 Wiring

| J2 (Black) Name | Name        |
|-----------------|-------------|
| C6              | Relay 6 COM |
| R6              | Relay 6 NO  |
| C5              | Relay 5 COM |
| R5              | Relay 5 NO  |
| C4              | Relay 4 COM |
| R4              | Relay 4 NO  |
| C3              | Relay 3 COM |
| R3              | Relay 3 NO  |
| C2              | Relay 2 COM |
| R2              | Relay 2 NO  |
| C1              | Relay 1 COM |
| R1              | Relay 1 NO  |
| H4              | HSC4 / IN12 |
| H3              | HSC3 / IN11 |
| H2              | HSC2 / IN10 |

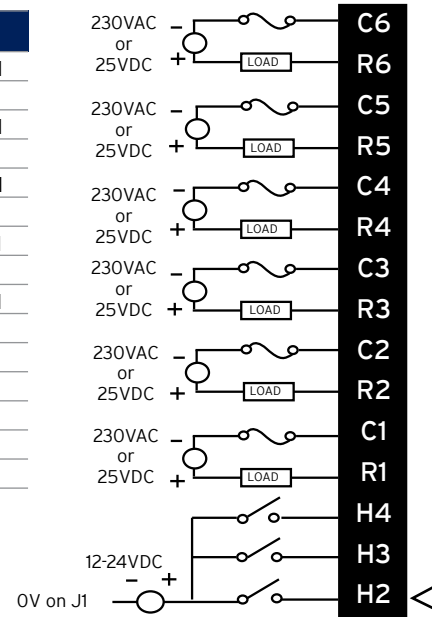

## 4 COMMUNICATIONS

### 4.1 - CAN Communications

#### 20mA Analog In - Not Self Powered

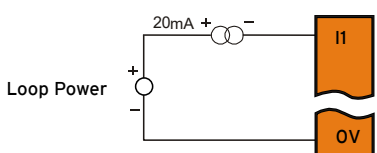

#### 20mA Analog In - Self Powered

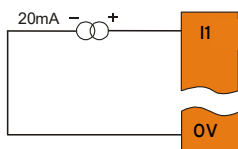

#### 0-10VDC IN

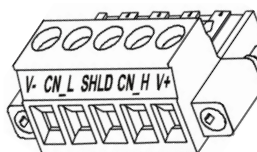
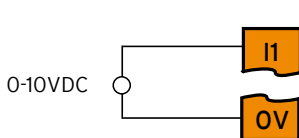

#### CAN Pin Assignments

| PIN | SIGNAL  | DESCRIPTION           |
|-----|---------|-----------------------|
| 1   | V-      | CAN Ground - Black    |
| 2   | CN L    | CAN Data Low - Blue   |
| 3   | SHLD    | Shield Ground - None  |
| 4   | CN H    | CAN Data High - White |
| 5   | V+ (NC) | No Connect - Red      |

#### CAN

Solid/Stranded Wire: 12-24 awg (2.5-0.2mm)

Strip Length: 0.28" (7mm)

Locking spring-clamp, two-terminators per conductor

Torque, Terminal Hold-Down Screws: 4.5 - 7 in-lbs (0.50 - 0.78 N-m)

V+ pin is not internally connected, the SHLD pin is connected to Earth ground via a 1MΩ resistor and 10 nF capacitor.

## communications continued...

## 5 ANALOG IN TRANZORB FAILURE

### 4.2- Serial Communications

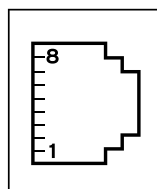

#### MJ1/2 SERIAL PORTS

Two Serial Ports on One Module Jack (8posn)

**MJ1:** RS-232 w/Full Handshaking

**MJ2:** RS-485 Half-Duplex

| MJ1 PINS |            |           | MJ2 PINS   |           |
|----------|------------|-----------|------------|-----------|
| PIN      | SIGNAL     | DIRECTION | SIGNAL     | DIRECTION |
| 8        | TXD        | OUT       | --         | --        |
| 7        | RXD        | IN        | --         | --        |
| 6        | 0V         | GROUND    | 0V         | GROUND    |
| 5        | +5V @ 60mA | OUT       | +5V @ 60mA | OUT       |
| 4        | RTS        | OUT       | --         | --        |
| 3        | CTS        | IN        | --         | --        |
| 2        | --         | --        | RX- / TX-  | IN / OUT  |
| 1        | --         | --        | RX+ / TX+  | IN / OUT  |

Attach optional ferrite core with a minimum of two turns of serial cable. See website for more details. [Part #: HE-FBD001]

### 4.3 - Dip Switches

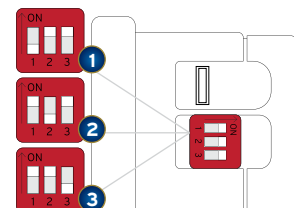

The DIP switches are used to provide a built-in termination to the MJ2 port if needed. The termination for these ports should only be used if this device is located at either end of the multidrop/ daisy-chained RS-485 network.

#### DIP SWITCHES

| PIN | NAME                   | FUNCTION        | DEFAULT |
|-----|------------------------|-----------------|---------|
| 1   | MJ1 RS-485 Termination | ON = Terminated | OFF     |
| 2   | Spare                  | Always OFF      | OFF     |
| 3   | Factory Use            | Always OFF      | OFF     |

### 4.4 - Ethernet Communications

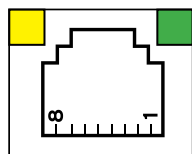

Green LED indicates link - when illuminated, data communication is available.

Yellow LED indicates activity - when flashing, data is in transmission.

A common cause of Analog Input Tranzorb Failure on Analog Inputs Model 2, 3, 4 & 5: If a 4- 20mA circuit is initially wired with loop power, but without a load, the Analog input could see 24VDC. This is higher than the rating of the tranzorb. This can be solved by NOT connecting loop power prior to load connection, or by installing a low-cost PTC in series between the load and Analog input.

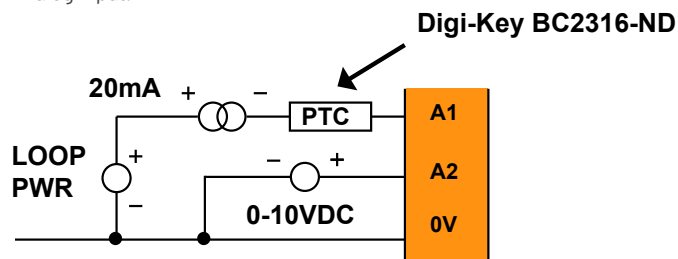

## 6 BUILT-IN I/O for Model 2

All XL4 models (except Model 0) feature built-in I/O. The I/O is mapped into OCS Register space, in three separate areas - Digital/Analog I/O, High-Speed Counter I/O, and High-speed Output I/O. Digital/Analog I/O location is fixed starting at 1, but the High-Speed Counter and High-Speed Output references may be mapped to any open register location. For more details, see the XL4 OCS User's Manual [MAN0964].

#### Digital and Analog I/O Functions

|                 |         |
|-----------------|---------|
| Digital Inputs  | %I1-12  |
| Reserved        | %I13-32 |
| ESCP Alarm      | n/a     |
| Digital Outputs | %Q1-6   |
| Reserved        | %Q7-24  |
| Analog Inputs   | %AI1-4  |
| Reserved        | %AI5-12 |
| Analog Outputs  | n/a     |
| Reserved        | n/a     |

#### Wiring Details:

Solid/Stranded Wire: 12-24 awg (2.5-0.2mm<sup>2</sup>).

Strip Length: 0.28" (7mm).

Torque, Terminal Hold-Down Screws: 4.5 - 7 in-lbs (0.50 - 0.78 N-m).

## 7 DIMENSIONS & INSTALLATION

## 8 BATTERY MAINTENANCE

### 7.1 - Dimensions



The XL4 has an advanced battery system that uses a rechargeable lithium battery. The battery powers the real time clock when power is removed, and it is needed for register data retention. Please reference the XL4 User Manual [MAN0964] which provides instructions on how to replace the battery.

**NOTE:** For detailed rechargeable battery information, refer to the Battery Manual [MAN1142].

## 9 ACCESSORIES

### 9.1 Backup Battery: HE-BAT00019

The XL4 uses rechargeable 3.6V lithium battery to run the Real-Time Clock and to maintain the retained register values. This battery is designed to maintain the clock and memory for 7-10 years.

### 9.2 Programming Cables Kit: HE-XCK

This programming cable kit includes the following adapter cables:

- USB to MiniUSB
- USB to RS-232 Serial
- RS-232 Serial to RJ45 Ethernet

### 9.3 2/4 Channel Analog Output Kit

- HE-XDAC007 - 2 Channel Analog Output I/O Kit
- HE-XDAC107 - 4 Channel Analog Output I/O Kit

Visit the Horner Website to purchase accessories.

### 7.2 - Installation Procedure

- The XL4 utilizes a clip installation method to ensure a robust and watertight seal to the enclosure. Please follow the steps below for the proper installation and operation of the unit.
  - This equipment is suitable for Class I, Division 2, Groups A, B, C and D or non-hazardous locations only.
  - Digital outputs shall be supplied from the same source as the operator control station.
  - Jumpers on connector JP1 shall not be removed or replaced while the circuit is live unless the area is known to be free of ignitable concentrations of flammable gases or vapors.
1. Carefully locate an appropriate place to mount the XL4. Be sure to leave enough room at the top of the unit for insertion and removal of the microSD™ card.
  2. Carefully cut the host panel per the diagram, creating a 92mm x 92mm +/-0.1mm opening into which the XL4 may be installed. If the opening is too large, water may leak into the enclosure, potentially damaging the unit. If the opening is too small, the OCS may not fit through the hole without damage.
  3. Remove any burrs and or sharp edges and ensure the panel is not warped in the cutting process.
  4. Remove all Removable Terminals from the XL4. Insert the XL4 through the panel cutout (from the front). The gasket must be between the host panel and the XL4.
  5. Install and tighten the four mounting clips (provided in the box) until the gasket forms a tight seal  
**NOTE: Max torque is 0.8 to 1.13Nm, 7 to 10 in-lbs.**
  6. Reinstall the XL4e I/O Removable Terminal Blocks. Connect communications cables to the serial port, USB ports, Ethernet port, and CAN port as required.

### XL4 User Manual [MAN0964]

The User Manual includes extensive information on:

- Built-in I/O
- Common %S & %SR Registers
- HSC/PWM/Totalizer/Quadrature & Accumulator Registers
- Resource Limits

## 10 SAFETY

### 10.1 - WARNINGS

1. To avoid the risk of electric shock or burns, always connect the safety (or earth) ground before making any other connections.
2. To reduce the risk of fire, electrical shock, or physical injury, it is strongly recommended to fuse the voltage measurement inputs. Be sure to locate fuses as close to the source as possible.
3. Replace fuse with the same type and rating to provide protection against risk of fire and shock hazards.
4. In the event of repeated failure, do NOT replace the fuse again as repeated failure indicates a defective condition that will NOT clear by replacing the fuse.
5. Only qualified electrical personnel familiar with the construction and operation of this equipment and the hazards involved should install, adjust, operate, or service this equipment. Read and understand this manual and other applicable manuals in their entirety before proceeding. Failure to observe this precaution could result in severe bodily injury or loss of life.
6. **WARNING** - Battery may explode if mistreated. Do not recharge, disassemble, or dispose of in fire.
7. **WARNING - EXPLOSION HAZARD** - Batteries must only be changed in an area known to be non-hazardous.

### 10.2 - FCC COMPLIANCE

This device complies with Part 15 of the FCC Rules. Operation is subject to the following two conditions:

1. This device may not cause harmful interference
2. This device must accept any interference received, including interference that may cause undesired operation

### 10.3 - PRECAUTIONS

All applicable codes and standards need to be followed in the installation of this product. Adhere to the following safety precautions whenever any type of connection is made to the module:

1. Connect the safety (earth) ground on the power connector first before making any other connections.
2. When connecting to the electric circuits or pulse-initiating equipment, open their related breakers.
3. Do NOT make connection to live power lines.
4. Make connections to the module first; then connect to the circuit to be monitored.
5. Route power wires in a safe manner in accordance with good practice and local codes.
6. Wear proper personal protective equipment including safety glasses and insulated gloves when making connections to power circuits.
7. Ensure hands, shoes, and floor are dry before making any connection to a power line.
8. Make sure the unit is turned OFF before making connection to terminals.
9. Make sure all circuits are de-energized before making connections.
10. Before each use, inspect all cables for breaks or cracks in the insulation. Replace immediately if defective.
11. Use copper conductors in Field Wiring only, 60/75°C.
12. Use caution when connecting controllers to PCs via serial or USB. PCs, especially laptops may use "floating power supplies" that are ungrounded. This could cause a damaging voltage potential between the laptop and controller. Ensure the controller and laptop are grounded for maximum protection. Consider using a USB isolator due to voltage potential differences as a preventative measure.

## 11 PART NUMBER

|         | Global   | European    |
|---------|----------|-------------|
| Model 2 | HE-XCIE2 | HEXT251C112 |

## 12 TECHNICAL SUPPORT

For assistance and manual updates, contact Technical Support at the following locations:

### North America

+1 (317) 916-4274  
 (877) 665-5666  
[www.hornerautomation.com](http://www.hornerautomation.com)  
 techsppt@heapg.com

### Europe

+353 (21) 4321-266  
[www.hornerautomation.eu](http://www.hornerautomation.eu)  
 technical.support@horner-apg.com