

X OCS MODEL: HE-X2

MODEL A BUILT-IN I/O: 12 DIGITAL INPUTS, 12 DIGITAL OUTPUTS, 4 ANALOG INPUTS, 2 ANALOG OUTPUTS
MODEL R BUILT-IN I/O: 12 DIGITAL INPUTS, 6 RELAY OUTPUTS, 2 PWM OUTPUTS, 4 ANALOG INPUTS, 2 ANALOG OUTPUTS

1 TECHNICAL SPECIFICATIONS

1.1 General

Primary Pwr. Range	24VDC +/- 20%
Typical power-backlight 100%	64mA @ 24V (1.53W)
Power Backlight Off	15mA @ 24V (0.36W)
Inrush Current	30A for < 1ms
Real Time Clock	Battery backed; lithium coin cell CR2450
Clock Accuracy	+/- 90 Secs/Month
Relative Humidity	5 to 95% Non-condensing
Operating Temp.	-10°C to +60°C
Storage Temp.	-20°C to +70°C
Weight	0.75 lb/ 340g
Mounting Clips	4 composite type
Housing Material	Polycarbonate, UL rated
Panel Seal	Silicone rubber
Packaging	100% recyclable paper fiber materials
Included in Box	Controller, 3 x I/O connectors, 4 x mounting clips, 1 x power connector, Quick Reference Guide

1.3 Connectivity

Serial Ports	1 x RS232, 1 x RS485
485 Terminations	On-board, software controlled
USB	Mini-B
USB Programming Support	Yes
USB Type	USB 2.0
CAN Hardware	Non-isolated
CAN Port Connector	RJ45 (red)
CAN Port Speeds Support	125kB, 250kB, 500kB, 1MB/sec.
CAN Port Termination	On-board, software controlled
CAN Protocols	CsCAN
Removable Memory In	microSD, SDHC, SDXC IN FAT32 format, support for 32GB max. Application Updates, Datalogging, more.

1.5 I/O Connections

Terminal Type	Removable 3.5mm color-coded
I/O Options	Onboard + Remote-SmartMod, SmartRail, SmartBlock, SmartStix
Remote I/O	SmartRail, SmartStix, SmartBlock, SmartMod

1.6 Testing

Shock	IEC 60068-2-27
Vibration	IEC 60068-2-6
Washdown	NEMA 4X
Certifications (UL/CE)	USA: https://hornerautomation.com/certifications/ Europe: http://www.horner-aga.com/en/support/certification.aspx

1.2 User Interface

Display	2.2" Monochrome LCD
Resolution	128 x 64 pixels
Backlight	LED
Backlight Lifetime	50,000 hrs
Backlight Control	Software controlled (ON/OFF)
User-Programmable Screens/Pages	250
No. of Objects/Screens	15
Screen Memory	256kB
Keypad	Membrane type switches w/metal dome
Tactile Feedback	Yes
Number of Keys	4 Soft keys + 16 numeric/function keys

1.4 Control & Logic

Control Language Support	Advanced ladder logic Full IEC 61131-3 languages
Logic Program Size	256kB
Non-Retentive Memory	128kB
Internal Storage Memory	16Mb
Total Program Memory	2.5Mb
Logic Scan Rate	1.2ms/kB
%I (Digital Inputs)	1024
%Q (Digital Outputs)	1024
%AI (Analog Inputs)	256
%AQ (Analog Outputs)	256
%M (Retentive Bits)	1024
%T (Temporary Bits)	1024
%R (Retentive Registers)	5000
%D (Display bits)	250
%K (Function Keys)	10
%S (System Bit)	16
%SR (System Register)	255

1.7 Inputs/Outputs Model Overview

	MODEL R	MODEL A
DC In	12	12
DC Out	2	12
Relays	6	-
HS In	4	4
HS Out	2	2
mA In	4	4
mA Out	2	2

There are four high-speed inputs of the total DC Inputs. There are two high-speed outputs of the total DC outputs.

Model A supports sourcing outputs. Model R DC outputs are sinking with integral pull up resistors.

technical specifications continued...

1.8 Digital DC Inputs: Models R & A

Inputs per Module	12 Including 4 Configurable HSC Inputs	
Commons per Module	1	
Input Voltage Range	12VDC / 24VDC	
Absolute Max. Voltage	35VDC Max.	
Input Impedance	10kΩ	
Input Current:	Positive Logic:	Negative Logic:
Upper Threshold	0.8mA	-1.6mA
Lower Threshold	0.3mA	-2.1mA
Max. Upper Threshold	8VDC	
Min. Lower Threshold	3VDC	
OFF to ON Response	0.1ms	
ON to OFF Response	0.1ms	
Number of Counters	4	
Maximum Frequency	2.5kHz, Quadrature 5kHz, Per Frequency 10kHz, Totalize	
Accumulator Size	32-bits each	
Modes Supported	Totalizer, quadrature, pulse measurement, frequency measurement, set-point controlled outputs	

1.10 Digital DC Outputs, Sinking: Model R

Outputs per Module	2 (PWM or HSC)
Commons per Module	1
Type	Sinking w/optional 10kΩ pull-up
Absolute Max. Voltage	28VDC
Output Protection	Short circuit
Max. Output per Point: Sinking	500mA
Max. Voltage Drop at Rated Current	0.25VDC
Max Inrush	650mA
OFF to ON Time	20μs
ON to OFF Time	10μs
PWM Out	65kHz
Rise Time	10μs
Fall Time	20μs

1.12 Analog Inputs: Models R & A

Number of Channels	4
Input Ranges	0-20mA, 4-20mA
Nominal Resolution	12 Bits
Safe Input Voltage Range	-0.5V to 12V, protection up to 24V
Input Impedance (clamped @ -0.5 VDC to 12 VDC)	Current Mode: 100Ω
Nominal Resolution	12 Bits
%AI Full Scale	32,000
Max. Over Current	35mA
Max Error at 25°C (excluding Zero) Adjusting Filtering may improve error	< 1.5%
Filtering	160Hz Hash (noise) Filter, 1-128 Scan Digital Running Average Filter

1.9 Relay Outputs: Model R

Outputs per Module	6 Relay
Commons per Module	6
Max. Current & Voltage per Relay	3A @ 60VAC, resistive 3A @ 30VDC, resistive
Max. Total Output Current	5A continuous
Max. Switched Power	150W
Contact Isolation to Ground	1000VAC
Max. Voltage Drop at Related Current	0.5V
Expected Life (see below derating chart for detail)	No Load: 5,000,000 Rated Load: 100,000
Max. Switching Rate	300 CPM at no load 20 CPM at rated load
Type	Mechanical Contact
Response Time	One update per ladder scan plus 10ms

1.11 Digital DC Outputs, Sourcing: Model A

Outputs per Module	12 Including 2 Configurable PWM Outputs
Commons per Module	2
Type	Sourcing / 10kΩ Pull-Down
Absolute Max. Voltage	28VDC
Output Protection	Short circuit
Max. Voltage Drop at Rated Current	0.25VDC
Max Inrush	650mA
Max Output per Point: Sourcing	2.4mA @ 24VDC
OFF to ON Time	1μs
ON to OFF Time	1μs
PWM Out	65kHz
Rise Time	150ns
Fall Time	150ns

1.13 Analog Outputs: Models R & A

Number of Channels	2
Output Ranges	4-20mA
Nominal Resolution	12 Bits
Update Rate	Once per PLC scan
Max. Error at 25°C (Excluding Zero)	< 1.5%
Maximum 20 mA Load	500Ω
% AQ Full Scale	32,000
Protection	Protect against miswire up to 24VDC auto-recover

2 WIRING & CONNECTIONS

wiring & connections continued...

2.1 - Port Connectors



- | | |
|---------------------------------|---------------|
| 1. Function Keys | 6. Analog I/O |
| 2. High Capacity microSD Slot | 7. DC Inputs |
| 3. RS232/RS485 Serial Connector | 8. DC Outputs |
| 4. CAN Port (via RJ45) | 9. DC Power |
| 5. USB Mini-B Port | |

2.2 - Power Wiring

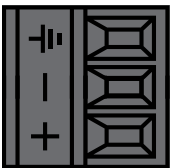

Primary Power Port Pins		
PIN	SIGNAL	DESCRIPTION
1	Ground	Frame Ground
2	DC-	Power Supply Common
3	DC+	Power Supply Voltage

DC Input / Frame

Solid/Stranded wire; 12-24 awg (2.5-0.2mm). Strip length - 0.28" (7mm).
 Torque rating: 4.5 - 7 in-lbs (0.50 - 0.78 Nm).
 DC- is internally connected to I/O OV.
 A Class 2 power supply must be used to meet UL requirements.

2.3 - Wiring Connectors

Model A - Digital Out J1 Wiring

POSITION/PIN	DIGITAL MODEL
1	Q1 Output 1 (PWM)
2	Q2 Output 2 (PWM)
3	Q3 Output 3
4	Q4 Output 4
5	V+ External V+
6	C Common
7	Q5 Output 5
8	Q6 Output 6
9	Q7 Output 7
10	Q8 Output 8
11	Q9 Output 9
12	Q10 Output 10
13	Q11 Output 11
14	Q12 Output 12
15	V+ External V 2 +
16	C Common

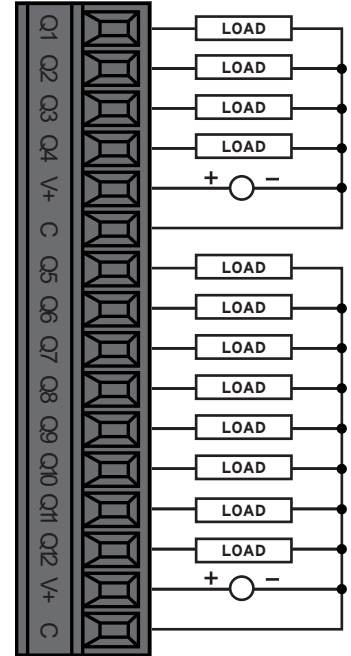

Model R - Relay and Digital Out J1 Wiring

POSITION/PIN	DIGITAL MODEL
1	R1 Relay 1 N.O.
2	C1 Relay 1 C
3	R2 Relay 2 N.O.
4	C2 Relay 2 C
5	R3 Relay 3 N.O.
6	C3 Relay 3 C
7	R4 Relay 4 N.O.
8	C4 Relay 4 C
9	R5 Relay 5 N.O.
10	C5 Relay 5 C
11	R6 Relay 6 N.O.
12	C6 Relay 6 C
13	Q1 Output 1
14	Q2 Output 2
15	V+ External V+
16	C Common

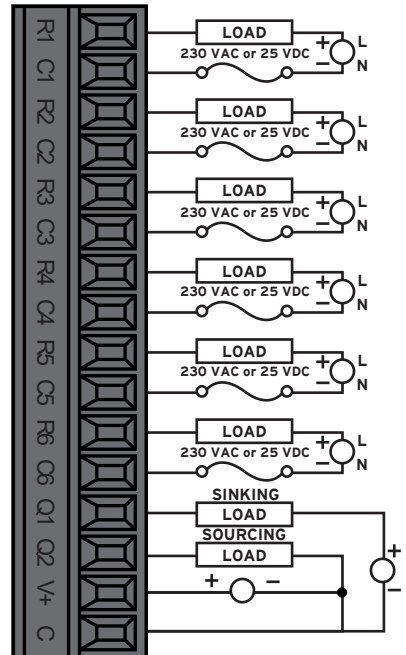

NOTE: Internal 10kΩ resistors between: V+ and Q1; V+ and Q2

wiring & connections continued...

Model R Sinking and Sourcing Outputs

Model R: Sinking Outputs

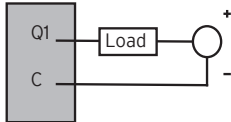

Model R: Sourcing Outputs

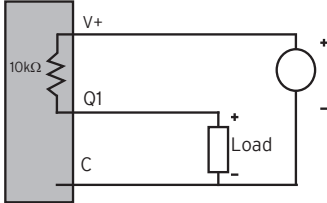

Sinking: Outputs can sink 500mA.
Sourcing: 2.4mA sourcing @ 24mA

wiring & connections continued...

Wiring Details:

Solid/Stranded wire - 12-24 awg (2.5-0.2 mm²).
 Strip length - 0.28" (7 mm).
 Torque rating: 4.5 - 7 in-lbs (0.50 - 0.78 N·m).

ANALOG INPUTS

Raw input values are found in the registers as Integer-type data with a range from 0 - 32000.

Analog inputs may be filtered digitally with the Filter Constant found in the Cscape Hardware Configuration for Analog Inputs. Valid filter values are 0 - 7 and act according to the following chart.

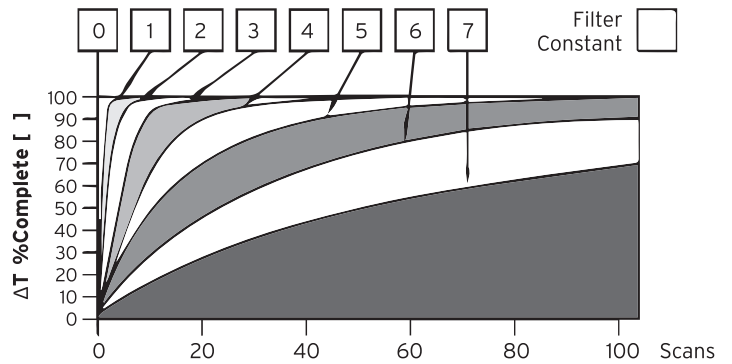

Positive Logic vs. Negative Logic Wiring

The OCS can be wired for positive logic inputs or negative.

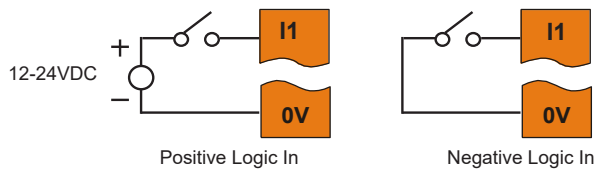

Model R & Model A - Digital Input J2 Wiring

POSITION/PIN	DIGITAL MODEL
1	I1 Input 1 (HSC)
2	I2 Input 2 (HSC)
3	I3 Input 3 (HSC)
4	I4 Input 4 (HSC)
5	I5 Input 5
6	I6 Input 6
7	I7 Input 7
8	I8 Input 8
9	I9 Input 9
10	I10 Input 10
11	I11 Input 11
12	I12 Input 12
13	C Common
14	C Common

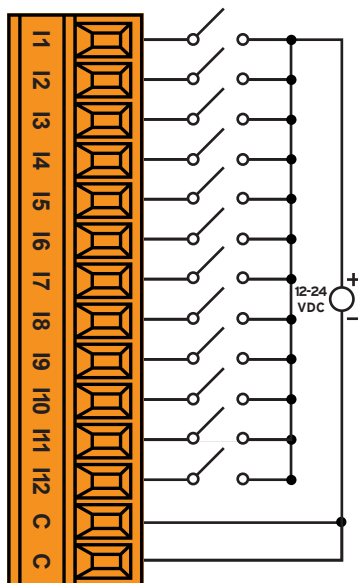

Model R & Model A - Analog Input and Output J3 Wiring

POSITION/PIN	DIGITAL MODEL
1	AI1 Analog Input 1
2	AI2 Analog Input 2
3	AI3 Analog Input 3
4	AI4 Analog Input 4
5	C Common
6	C Common
7	AQ1 Analog Output 1
8	AQ2 Analog Output 2
9	C Common

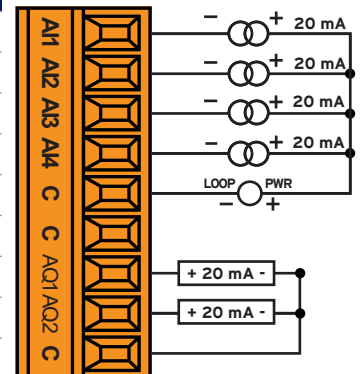

3 COMMUNICATIONS

3.1 - CAN Communications

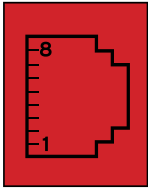

CAN
Modular jack (8posn RJ45)

CAN Pin Assignments	
PIN	SIGNAL
8	No Connection
7	Ground
6	Shield
5	No Connection
4	No Connection
3	Ground
2	CAN Data Low
1	CAN Data High

The CAN port is provided via the single 8-position modular jack labeled "CAN". It may be used to communicate with other OCS products using Horner's CsCAN protocol. Additionally, remote expansion I/O such as SmartRail, SmartBlock, and SmartStix may be implemented using the CsCAN protocol.

Termination for the CAN port may be enabled from the System Menu or System Register. This should only occur if the X2 is at one end of the CAN network or the other. Only the two devices on either end of the CAN network should be terminated.

3.2 - Serial Communications

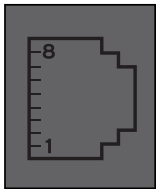

MJ1: RS-232 w/full handshaking

MJ2: RS-485 half-duplex

RS-485 termination and biasing via System Menu or System Register

MJ1 PIN			MJ2 PIN	
PIN	SIGNAL	DIRECTION	SIGNAL	DIRECTION
8	TXD	OUT	--	
7	RXD	IN	--	
6	0V	Common	0 V	Common
5	+5VDC @ 60mA	OUT	+5VDC @ +/- 60mA	OUT
4	RTS	OUT	--	--
3	CTS	IN	--	--
2	--	--	RX- / TX-	IN / OUT
1	--	--	RX+ / TX+	IN / OUT

4 BUILT-IN I/O

4.1 - Built-in I/O (Model R & Model A)

Both X2 feature built-in I/O. The I/O is mapped into OCS Register space, in three separate areas - Digital/Analog I/O, High-Speed Counter I/O, and High-speed Output I/O. Digital/Analog I/O location is fixed starting at 1, but the high-speed counter and high-speed output references may be mapped to any open register location. For more details on using the high-speed counter and high-speed outputs, see the X2 OCS User's Manual (MAN1130).

FIXED ADDRESS	DIGITAL/ANALOG I/O FUNCTION	MODEL R	MODEL A
%I	Digital Inputs	1-12	1-12
	Reserved	13-32	13-32
%Q	Digital Outputs	1-6	1-12
	Reserved	7-16	13-16
%AI	Analog Inputs	1-4	1-4
	Reserved	5-12	5-12
%AQ	Analog Outputs	1-2	1-2
	Reserved	3-6	3-6

Reserved areas maintain backward compatibility with other models.

5 INSTALLATION DIMENSIONS

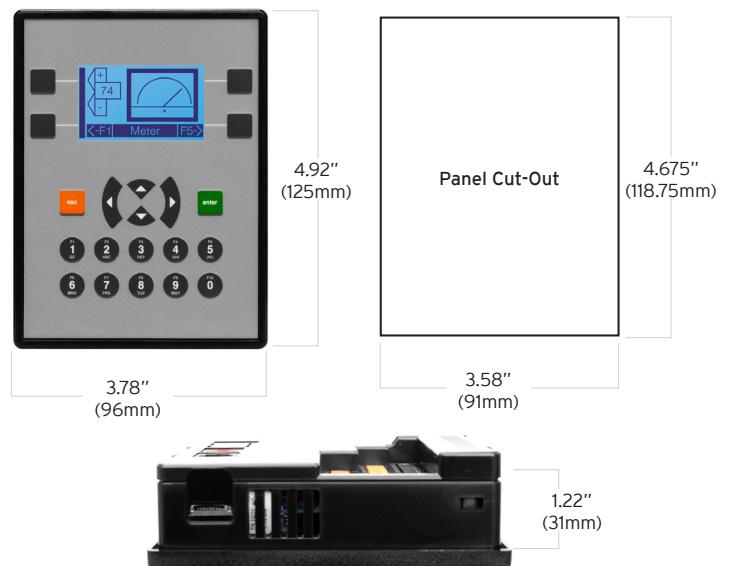

installation continued...

7 BATTERY

5.1 - Installation Procedure

The X2 utilizes a clip installation method to ensure a robust and watertight seal to the enclosure. Please follow the steps below for the proper installation and operation of the unit.

1. Carefully locate an appropriate place to mount the X2. Be sure to leave enough room at the top of the unit for insertion and removal of the microSD™ card.
2. Carefully cut the host panel per the diagram, creating a 91mm x 118.75mm +/-0.1mm opening into which the X2 is to be installed. If the opening is too large, water may leak into the enclosure, potentially damaging the unit. If the opening is too small, the OCS may not fit through the hole without damage.
3. Remove any burrs/sharp edges and ensure the panel is not warped in the cutting process.
4. Install and tighten the four mounting clips (provided in the box) until the gasket forms a tight seal. For standard composite mounting clips (included with product), use a torque rating of 2-3 in-lbs (0.23-0.34 Nm). For optional metal mounting clips, use a torque rating of 4-8 in-lbs (0.45-0.90 Nm).
5. Connect communications cables to the serial port, USB ports, and CAN port as required.

6 SAFETY

6.1 - WARNINGS

1. To avoid the risk of electric shock or burns, always connect the safety (or earth) ground before making any other connections.
2. To reduce the risk of fire, electrical shock, or physical injury, it is strongly recommended to fuse the voltage measurement inputs. Be sure to locate fuses as close to the source as possible.
3. Replace fuse with the same type and rating to provide protection against risk of fire and shock hazards.
4. In the event of repeated failure, do NOT replace the fuse again as repeated failure indicates a defective condition that will NOT clear by replacing the fuse.
5. Only qualified electrical personnel familiar with the construction and operation of this equipment and the hazards involved should install, adjust, operate, or service this equipment. Read and understand this manual and other applicable manuals in their entirety before proceeding. Failure to observe this precaution could result in severe bodily injury or loss of life.

6.2 - FCC COMPLIANCE

This device complies with Part 15 of the FCC Rules. Operation is subject to the following two conditions:

1. This device may not cause harmful interference
2. This device must accept any interference received, including interference that may cause undesired operation.

7.3 - PRECAUTIONS

All applicable codes and standards need to be followed in the installation of this product. Adhere to the following safety precautions whenever any type of connection is made to the module:

1. Connect the safety (earth) ground on the power connector first before making any other connections.
2. When connecting to the electric circuits or pulse-initiating equipment, open their related breakers.
3. Do NOT make connection to live power lines.
4. Make connections to the module first; then connect to the circuit to be monitored.
5. Route power wires in a safe manner in accordance with good practice and local codes.
6. Wear proper personal protective equipment including safety glasses and insulated gloves when making connections to power circuits.
7. Ensure hands, shoes, and floor are dry before making any connection to a power line.
8. Make sure the unit is turned OFF before making connection to terminals.
9. Make sure all circuits are de-energized before making connections.
10. Before each use, inspect all cables for breaks or cracks in the insulation. Replace immediately if defective.
11. Use copper conductors in Field Wiring only, 60/75°C.

The X2 uses a replaceable non-rechargeable 3 V Lithium coin-cell battery (CR2450) to run the Real-Time Clock and to maintain the retained register values. This battery is designed to maintain the clock and retained registers for 7-10 years. Please reference MAN1130 for instructions on how to replace the battery.

8 TECHNICAL SUPPORT

For assistance and manual updates, contact Technical Support at the following locations:

North America

(877) 665-5666
(317) 916-4274
www.hornerautomation.com
techsppt@heapg.com

Europe

(+) 353-21-4321-266
www.horner-apg.com
techsppt@horner-apg.com

9 PART NUMBER BUILDER

EXAMPLE PART NUMBERS

GLOBAL MODEL NUMBERS

model

HE-X2

R relay and solid state outputs
A solid state output