

# EXL10 OCS DATASHEET

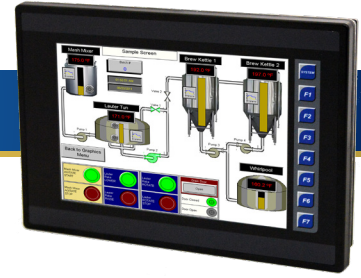

**MODEL 4**  
24 DC In, 16 DC Out, 2 - 12-bit Analog In

## 1 TECHNICAL SPECIFICATIONS

### 1.1 General Specifications

Required Power (Steady State)	650mA @ 24VDC
Required Power (Inrush)	25A for < 1ms @ 24VDC, DC switched
Primary Power Range	10 - 30VDC
Relative Humidity	5 to 95% non-condensing
Clock Accuracy	+ / - 20 ppm maximum at 25°C (+/- 1 min/month)
Real Time Clock	Battery Backed, Rechargeable Lithium
Surrounding Air Temp	-10°C to +60°C
Storage Temp	-20°C to +60°C
Weight	4.375 lbs. / 1984.45g
Certifications (UL/CE)	North America: <a href="https://hornerautomation.com/certifications/">https://hornerautomation.com/certifications/</a> Europe: <a href="http://www.horner-apg.com/en/support/certification.aspx">http://www.horner-apg.com/en/support/certification.aspx</a>

### 1.2 Connectivity

Serial Ports	1 RS-232 and 1 RS-485 on first Modular Jack (MJ1/2) 1 RS-232 or 1 RS-485 on second Modular Jack
USB mini-B	USB 2.0 (480MHz) Programming & Data Access
USB A	USB 2.0 (480MHz) for USB flash drives (2TB)
CAN Port Isolated 1 kV	Remote I/O, Peer-to-peer Comms, Cscape
CAN Protocols	CsCAN, CANopen, DeviceNet, J1939
2 x Ethernet	10/100 Mb (Auto-MDX)
Ethernet Protocols	TCP/IP, Modbus TCP, FTP, SMTP, EGD, ICMP, ASCII, Cscape, Ethernet IP, HTTP
Remote I/O	SmartRail, SmartStix, SmartBlock, SmartMod
Removable Memory	microSD, SDHC, SDXC IN FAT32 format, support for 32GB max. Application Updates, Datalogging, and more
Audio	Mic In, Line In, Line Out

### 1.3 Control & Logic

Control Language Support	Advanced Ladder Logic Full IEC 61131-3 Languages Tag-Based Editor
Logic Program Size	1 MB, maximum
Logic Scan Rate	0.013ms/kB
Digital Inputs	2048
Digital Outputs	2048
Analog Inputs	512
Analog Outputs	512
Gen. Purpose Registers	50,000 (words) Retentive 16,384 (bits) Retentive 16,384 (bits) Non-retentive

### 1.4 User Interface

Display Type	10.4" VGA TFT (550 nit typical)
Resolution	640 x 480
Color	16-bit (65,536)
Screen Memory	27MB
User-Program. Screens	1023
Backlight	LED - 50,000 hour life
Screen Update Rate	User Configurable within the scan time. (Perceived as instantaneous in many cases.)

### 1.5 High-Speed Inputs

Number of Counters	4
Maximum Frequency	1MHz Max
Accumulator Size	32-bits each
Modes Supported	Totalizer, quadrature, pulse measurement, frequency measurement, set-point controlled outputs

### 1.6 High-Speed Outputs

Modes Supported	Stepper, PWM
Output Frequency	500kHz

## technical specifications continued...

### 1.7 Digital DC Inputs

Inputs per Module	24 Including 4 Configurable HSC Inputs	
Commons per Module	1	
Input Voltage Range	12VDC / 24VDC	
Absolute Max. Voltage	35VDC Max.	
Input Impedance	10kΩ	
Input Current	Positive Logic	Negative Logic
Upper Threshold	0.8mA	-1.6mA
Lower Threshold	0.3mA	-2.1mA
Max. Upper Threshold	8VDC	
Min. Lower Threshold	3VDC	
OFF to ON Response	1ms	
ON to OFF Response	1ms	
High Speed Counter Max Freq*	1MHz	

\*See I/O info below for detail regarding HSC and PWM

### 1.8 Digital DC Outputs

Outputs per Module	16 Including 2 Configurable PWM Outputs
Commons per Module	1
Output Type	Sourcing / 10kΩ Pull-Down
Output Frequency	500kHz
Absolute Max. Voltage	28VDC Max.
Output Protection	Short Circuit
Max. Output Current/Point	0.5A
Max. Total Current	4A Continuous
Max. Output Supply Voltage	30VDC
Min. Output Supply Voltage	10VDC
Max. Voltage Drop at Rated Current	0.25VDC
Max. Inrush Current	650mA per Channel
Min. Load	None
OFF to ON Response	1ms
ON to OFF Response	1ms
Output Characteristics	Current Sourcing (Pos. Logic)
PWM Out	≈ 5kHz
Rise Time	50 - 115μs
Fall Time	8-20μs

### 1.9 Analog Inputs

Number of Channels	2
Input Ranges	0 - 10VDC 0 - 20mA 4 - 20mA
Safe Input Range	-0.5V to +12V
Input Impedance (Clamped @ -0.5 VDC to 12 VDC)	Current Mode: 100Ω Voltage Mode: 500Ω
Nominal Resolution	12 Bits
%AI full scale	32,000 counts
Max. Over-Current	35mA
Conversion Speed	All channels converted once per ladder scan
Max. Error @25°C (excluding zero)	4-20mA 1.00% 0-20mA 1.00% 0-10VDC 0.50%
Filtering	160Hz hash (noise) filter 1/28 scan digital running average filter

## 2 CONTROLLER OVERVIEW

### 2.1 - Overview of EXL10



1. Touchscreen
2. Function Keys
3. Audio Out/In
4. USB 2.0 'A': Flash Storage
5. LAN1 Port
6. LAN2 Port
7. Built-In I/O
8. MJ1/MJ2: RS-232 & 1/2 Duplex RS-485
9. Dip Switches
10. MJ3: RS-232/485
11. CAN1: Can I/O & Fieldbus Port
12. Power: 10-30VDC In
13. microSD: Data Storage
14. USB mini 'B': Programming
15. CAN 2: CAN I/O

## controller overview continued...

### 2.2 - Power Wiring

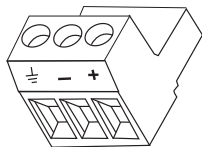

Primary Power Port Pins		
PIN	SIGNAL	DESCRIPTION
1	Ground	Frame Ground
2	DC-	Input Power Supply Ground
3	DC+	Input Power Supply Voltage

#### DC Input / Frame

Solid/Stranded wire: 12-24 awg (2.5-0.2mm).  
 Strip length: 0.28" (7mm).  
 Torque rating: 4.5 - 7 in-lbs (0.50 - 0.78 N-m).  
 DC- is internally connected to I/O V-, but is isolated from CAN V-.  
 A Class 2 power supply must be used.

## 3 WIRING: INPUTS AND OUTPUTS

### 3.1 - Digital Input & Output Information

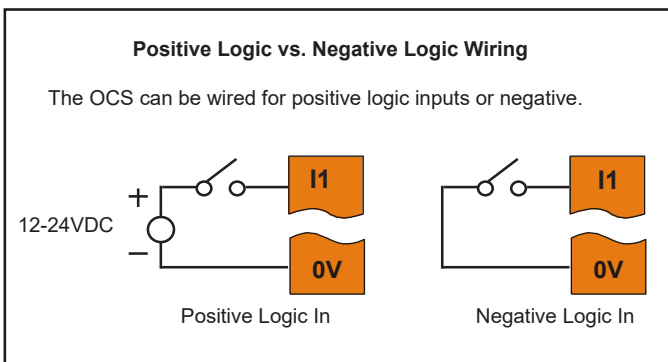

#### DIGITAL INPUTS

Digital inputs may be wired in either a Positive Logic or Negative Logic fashion as shown. The setting in the Cscape Hardware Configuration for the Digital Inputs must match the wiring used in order for the correct input states to be registered. No jumper settings are required for EXL10. When used as a normal input and not for high speed functions, the state of the input is reflected in registers %I1 - %I12.

Digital inputs may alternately be specified for use with High Speed Counter functions, also found in the Hardware Configuration for Digital Inputs. Refer to the EXL10 User Manual [MAN1029] for full details.

## wiring: I-O continued...

### 3.2 - Analog Input Information

#### ANALOG INPUTS

Raw input values for channels 1-4 are found in the registers as Integer-type data with a range from 0 - 32000.

Analog inputs may be filtered digitally with the Filter Constant found in the Cscape Hardware Configuration for Analog Inputs. Valid filter values are 0 - 7 and act according to the following chart.

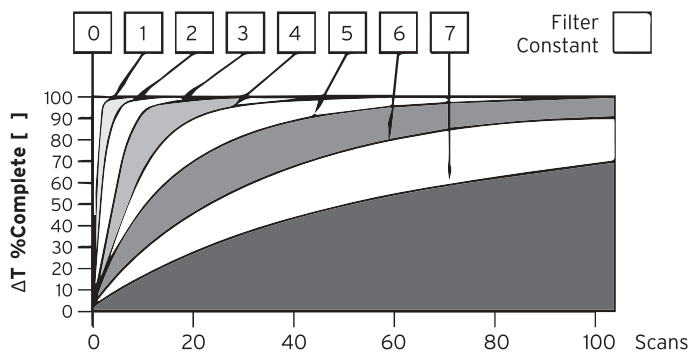

Data Values	
INPUT MODE:	DATA FORMAT, 12-bit INT:
0-20mA, 4-20mA	0-32000
0-10V	0-32000

### 3.3 - Jumper Setting Details

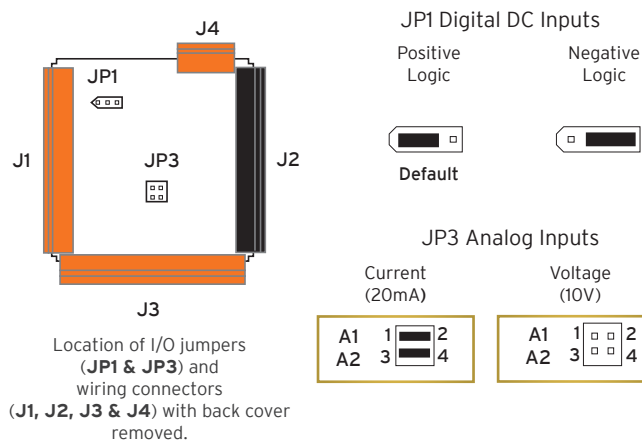

**NOTE:** The Cscape Module Configuration must match the selected I/O (JP) jumper settings.  
 (Cscape Path: **Controller** -> **Hardware Configuration** -> **Local I/O** -> **Config** -> **Module Setup** -> **Analog In**)

**NOTE:** When using JP3 (A1-A2), each channel can be independently configured.

wiring: I-O continued on next page...

## wiring: I-O continued...

### 3.4 - Digital In / Analog In Wiring

#### Digital In / Analog In J1 Wiring

J1 (Orange) Name	
I1	IN1
I2	IN2
I3	IN3
I4	IN4
I5	IN5
I6	IN6
I7	IN7
I8	IN8
H1	HSC1 / IN9
H2	HSC2 / IN10
H3	HSC3 / IN11
H4	HSC4 / IN12
A1	Analog IN1
A2	Analog IN2
OV	Common

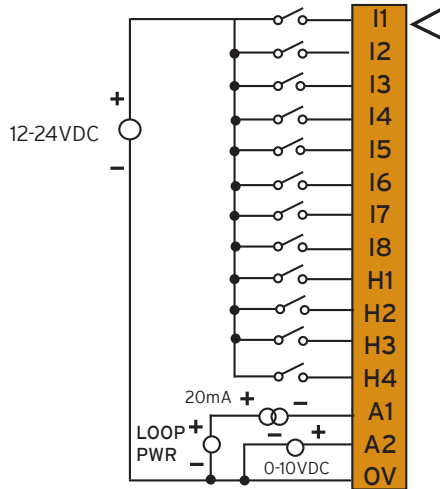

#### Digital In J3 Wiring

J3 (Orange) Name	
I13	IN13
I14	IN14
I15	IN15
I16	IN16
I17	IN17
I18	IN18
I19	IN19
I20	IN20
I21	IN21
I22	IN22
I23	IN23
I24	IN24
OV	Common

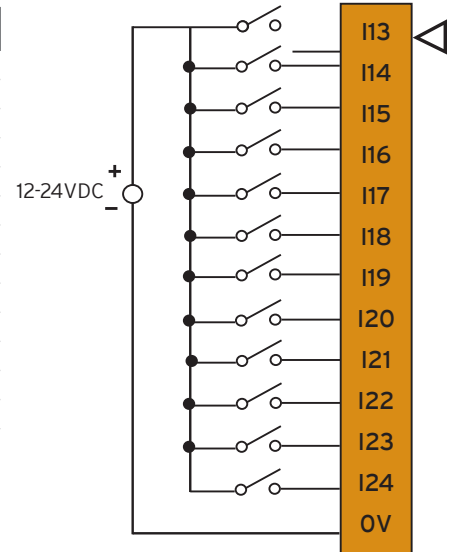

### 3.5 - Relay Out / Digital In & Out Wiring

#### Relay Out / Digital In J2 Wiring

J2 (Black) Name	
OV	Common
V+	V+
NC	No Connect
Q12	OUT 12
Q11	OUT 11
Q10	OUT 10
Q9	OUT 9
Q8	OUT 8
Q7	OUT 7
Q6	OUT 6
Q5	OUT 5
Q4	OUT 4
Q3	OUT 3
Q2	OUT2/PWM2
Q1	OUT1/PWM1

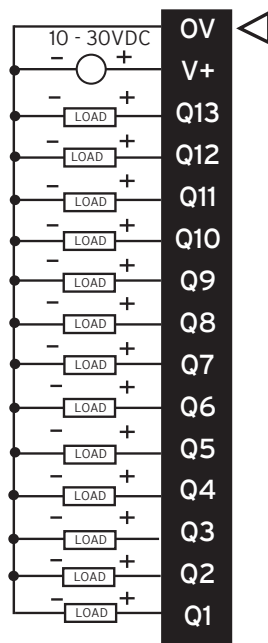

#### Positive Logic - Digital Out J4 Wiring

J4 (Orange) Name	
Q16	OUT16
Q15	OUT15
Q14	OUT14

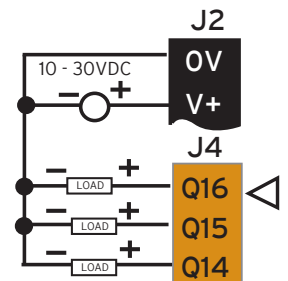

#### Wiring Details:

Solid/Stranded wire - 12-24 awg (2.5-0.2 mm<sup>2</sup>).  
Strip length - 0.28" (7 mm).  
Torque rating: 4.5 - 7 in-lbs (0.50 - 0.78 N-m).

## 4 COMMUNICATIONS

## communications continued...

### 4.1 - CAN Communications

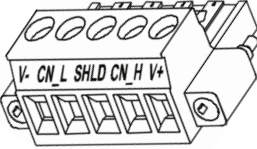

CAN Pin Assignments		
PIN	SIGNAL	DESCRIPTION
1	V-	CAN Ground - Black
2	CN L	CAN Data Low - Blue
3	SHLD	Shield Ground - None
4	CN H	CAN Data High - White
5	V+ (NC)	No Connect - Red

#### CAN

Solid/Stranded wire: 12-24 awg (2.5-0.2mm).  
 Strip length: 0.28" (7mm).  
 Locking spring-clamp, two-terminators per conductor.  
 Torque Rating: 4.5 in-lbs (0.50 N-m).  
 V+ pin is not internally connected, the SHLD pin is connected to Earth ground via a 1 MΩ resistor and 10nF capacitor.

### serial communications continued...

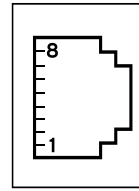

#### MJ3 SERIAL PORT

2 Multiplexed Serial Ports on One Modular Jack (8posn)

MJ3 PINS		
PIN	SIGNAL	DIRECTION
8	TXD RS232	OUT
7	RXD RS232	IN
6	0V	GROUND
5	+5V @ 60mA	OUT
4	TX- RS485	OUT
3	TX+ RS485	OUT
2	RX- RS485	IN
1	RX+ RS485-	IN

### 4.2 - Serial Communications

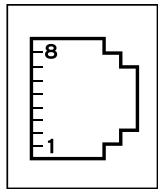

#### MJ1/2 SERIAL PORTS

Two Serial Ports on One Module Jack (8posn)

MJ1: RS-232 w/Full Handshaking  
 J2: RS-232 Half-Duplex

MJ1 PINS			MJ2 PINS	
PIN	SIGNAL	DIRECTION	SIGNAL	DIRECTION
8	TXD	OUT	--	--
7	RXD	IN	--	--
6	0V	GROUND	0V	GROUND
5	+5V @ 60mA	OUT	+5V @ 60mA	OUT
4	RTS	OUT	--	--
3	CTS	IN	--	--
2	--	--	RX- / TX-	IN / OUT
1	--	--	RX+ / TX+	IN / OUT

#### EXL10 User Manual [MAN1029]

The User Manual includes extensive information on:

- Built-in I/O
- Common %S & %SR Registers
- HSC/PWM/Totalizer/Quadrature & Accumulator Registers
- Resource Limits

### 4.3 - Dip Switches

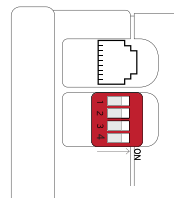

#### DIP SWITCHES

PIN	NAME	FUNCTION	DEFAULT
1	MJ3 RS485 Termination	ON = Terminated	OFF
2	MJ3 Duplex	ON = Half	OFF
3		OFF = Full	OFF
4	MJ2 RS485 Termination	ON = Terminated	OFF

The DIP switches are used to provide a built-in termination to both the MJ1, MJ2 & MJ3 ports if needed. The termination for these ports should only be used if this device is located at either end of the multidrop/daisy-chained RS-485 network.

### 4.4 - Ethernet Communications

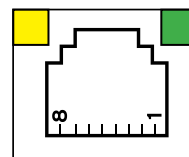

Green LED indicates link - when illuminated, data communication is available.

Yellow LED indicates activity - when flashing, data is in transmission.

## 5 BUILT-IN I/O

### Built-In I/O ( EXL10, Model 4)

All EXL10 models (except the Model 0) feature built-in I/O. The I/O is mapped into OCS Register space, in three separate areas - digital/analog I/O, high-speed counter I/O, and high-speed output I/O. Digital/analog I/O location is fixed starting at 1, but the high-speed counter and high-speed output references may be mapped to any open register location. For more details, see the EXL10 OCS User's Manual [MAN1029].

#### 5.1 Digital and Analog I/O Functions

Digital Inputs	%I1-24
Reserved	%I25-31
ESCP Alarm	%I32
Digital Outputs	%Q1-16
Reserved	%Q17-24
Analog Inputs	%AI1-2
Reserved	%AI3-12
Analog Outputs	n/a
Reserved	%AQ1-8

## 6 ANALOG IN TRANZORB FAILURE

A common cause of Analog Input Tranzorb Failure on Analog Inputs Model 2, 3, 4 & 5: If a 4- 20mA circuit is initially wired with loop power, but without a load, the Analog input could see 24VDC. This is higher than the rating of the tranzorb. This can be solved by NOT connecting loop power prior to load connection, or by installing a low-cost PTC in series between the load and analog input.

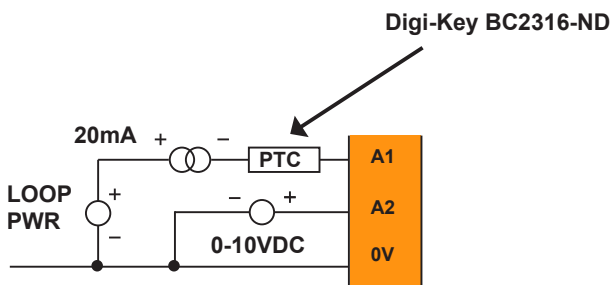

## 7 BATTERY

The EXL10 has an advanced battery system that uses a rechargeable lithium battery. The battery powers the real time clock when power is removed, and it is needed for register data retention. Please reference the EXL10 User Manual [MAN1029] which provides instructions on how to replace the battery.

## 8 INSTALLATION & DIMENSIONS

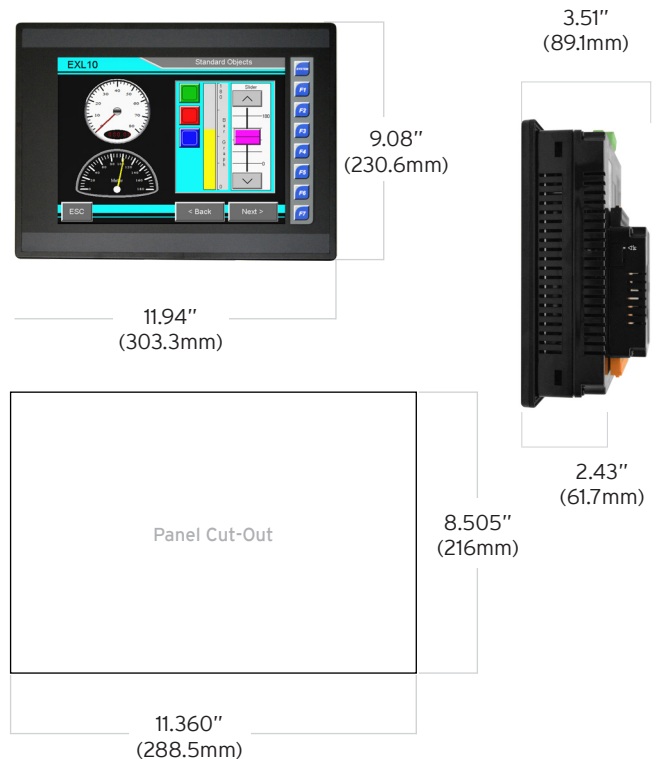

### 7.1 - Installation Procedure

The EXL10 utilizes a clip installation method to ensure a robust and watertight seal to the enclosure. Please follow the steps below for the proper installation and operation of the unit.

- Carefully locate an appropriate place to mount the EXL10. Be sure to leave enough room at the top of the unit for insertion and removal of the microSD™ card.
- Carefully cut the host panel per the diagram, creating a 216mm x 288.5mm +/-0.1 mm opening into which the EXL10 may be installed. If the opening is too large, water may leak into the enclosure, potentially damaging the unit. If the opening is too small, the OCS may not fit through the hole without damage.
- Remove any burrs and or sharp edges and ensure the panel is not warped in the cutting process.
- Remove all Removable Terminals from the EXL10. Insert the EXL10 through the panel cutout (from the front). The gasket must be between the host panel and the EXL10.
- Install and tighten the four mounting clips (provided in the box) until the gasket forms a tight seal (max torque 0.8 to 1.13 N m, or 7-10 in-lbs).
- Reinstall the EXL10 I/O Removable Terminal Blocks. Connect communications cables to the serial port, USB ports, Ethernet port, and CAN port as required.



## 9 SAFETY & WARNINGS

### 9.1 - WARNINGS

- To avoid the risk of electric shock or burns, always connect the safety (or earth) ground before making any other connections.
- To reduce the risk of fire, electrical shock, or physical injury, it is strongly recommended to fuse the voltage measurement inputs. Be sure to locate fuses as close to the source as possible.
- Replace fuse with the same type and rating to provide protection against risk of fire and shock hazards.
- In the event of repeated failure, do NOT replace the fuse again as repeated failure indicates a defective condition that will NOT clear by replacing the fuse.
- Only qualified electrical personnel familiar with the construction and operation of this equipment and the hazards involved should install, adjust, operate, or service this equipment. Read and understand this manual and other applicable manuals in their entirety before proceeding. Failure to observe this precaution could result in severe bodily injury or loss of life.

### 9.2 - FCC COMPLIANCE

This device complies with Part 15 of the FCC Rules. Operation is subject to the following two conditions:

- This device may not cause harmful interference
- This device must accept any interference received, including interference that may cause undesired operation

### 9.3 - PRECAUTIONS

All applicable codes and standards need to be followed in the installation of this product. Adhere to the following safety precautions whenever any type of connection is made to the module:

- Connect the safety (earth) ground on the power connector first before making any other connections.
- When connecting to the electric circuits or pulse-initiating equipment, open their related breakers.
- Do NOT make connection to live power lines.
- Make connections to the module first; then connect to the circuit to be monitored.
- Route power wires in a safe manner in accordance with good practice and local codes.
- Wear proper personal protective equipment including safety glasses and insulated gloves when making connections to power circuits.
- Ensure hands, shoes, and floor are dry before making any connection to a power line.
- Make sure the unit is turned OFF before making connection to terminals.
- Make sure all circuits are de-energized before making connections.
- Before each use, inspect all cables for breaks or cracks in the insulation. Replace immediately if defective.
- Use copper conductors in Field Wiring only, 60/75°C.

## 10 TECHNICAL SUPPORT

For assistance and manual updates, contact Technical Support at the following locations:

**North America**  
 (317) 916-4274  
 www.hornerautomation.com  
 techspt@heapg.com

**Europe**  
 (+) 353-21-4321-266  
 www.horner-apg.com  
 technical.support@horner-apg.com

## 11 PART NUMBER BUILDER

### EXAMPLE PART NUMBERS

#### GLOBAL MODEL NUMBERS

	screen	Ethernet	I/O
HE-X	<input type="text"/>	<input type="text"/>	<input type="text"/>
	E (no touchscreen) T (touchscreen)	O (no Ethernet) E (Ethernet)	0 (model 0) 2 (model 2) 3 (model 3) 4 (model 4) 5 (model 5) 6 (model 6)

#### EUROPEAN MODEL NUMBERS

	screen	Ethernet	CAN option	I/O	overlay type
HEX	<input type="text"/>	<input type="text"/>	C <input type="text"/>	<input type="text"/>	<input type="text"/>
	E22 (no touchscreen) T24 (touchscreen)	0 (no Ethernet) 1 (Ethernet)	0 (no CAN*) 1 (CSCAN) 2 (CANopen) 4 (DeviceNet) 5 (J1939)	00 (model 0) 12 (model 2) 13 (model 3) 14 (model 4) 15 (model 5) 16 (model 6)	00 (dark colour) 01 (light colour) 02 (blank) 03-99 (custom)