



XL4 OCS DATASHEET

MODEL 5

12 DC In, 12 DC Out, 2 - 14/16-bit Analog In (mA/V/Tc/mV/RTD), 2 - 12-bit Analog Out

1 TECHNICAL SPECIFICATIONS

1.1 General

Typical Power-Backlight 100%	442mA @ 10V (4.42W), 221mA @ 24V (5.30W)
Power Backlight Off	-24mA @ 24VDC (.58W)
Power Backlight @50%	-18mA @ 24VDC (0.43W)
Required Power (Steady State)	221mA @ 24VDC (2.21W) 442mA @ 10VDC (4.42W)
Heater Option	355mA with heater operating (24VDC) 520mA with heater operating (12VDC) *Heater option (Model# plus "-22") requires VDC for -40°
Required Power (Inrush)	2A for < 1ms @ 24VDC, DC switched
Primary Power Range	10 - 30VDC 10 - 24VDC (with Heater Option)
Relative Humidity	5 to 95% non-condensing
Real Time Clock	Battery Backed, lithium coin cell CR2450
Clock Accuracy	+ / - 20 ppm maximum at 25°C (+/- 1 min/month)
Operating Temperature	-10°C to +60°C (-22 Heater Option range is -40°C to +60°C)
Storage Temperature	-20°C to +60°C
Weight	12 oz / 340g (without I/O)
Certifications (UL/CE)	North America: https://hornerautomation.com/certifications/ Europe: http://www.horner-apg.com/en/support/certification.aspx

1.2 Control & Logic

Control Language Support	Advanced Ladder Logic Full IEC 61131-3 Languages
Logic Program Size	1 MB, maximum
Logic Scan Rate	0.013ms/kB
Digital Inputs	2048
Digital Outputs	2048
Analog Inputs	512
Analog Outputs	512
Gen. Purpose Registers	50,000 (words) Retentive 16,384 (bits) Retentive 16,384 (bits) Non-retentive

1.3 Connectivity

Serial Ports	1 RS-232 and 1 RS-485 on singular Modular Jack (MJ1)
USB mini-B	USB 2.0 (480MHz) Programming & Data Access
USB A	USB 2.0 (480 MHz) for USB flash drives (2TB)
CAN Port Isolated 1 kV	Remote I/O, Peer-to-peer Comms, Cscope
CAN Protocols	CsCAN, CANopen, DeviceNet, J1939
Ethernet	10/100 Mb (Auto-MDX)
Ethernet Protocols	TCP/IP, Modbus TCP, FTP, SRTP, EGD, ICMP, ASCII
Remote I/O	SmartRail, SmartStix, SmartBlock, SmartMod
Removable Memory	microSD, SDHC, SDXC IN FAT32 format, support for 32GB max. Application Updates, Datalogging, and more

1.4 User Interface

Display Type	3.5" TFT Transmissive Color
Resolution	QVGA (320 x 240)
Color	16-bit (65,535)
User-Program. Screens	1023
Backlight	LED - 50,000 hour life
Screen Update Rate	User Configurable within the scan time.

1.5 High-Speed Inputs

Number of Counters	4
Maximum Frequency	1MHz each
Accumulator Size	32-bits each
Modes Supported	Totalizer, quadrature, pulse measurement, frequency measurement, set-point controlled outputs

1.6 High-Speed Outputs

Modes Supported	Stepper, PWM
Output Frequency	500kHz

technical specifications continued...

1.7 Digital DC Inputs

Inputs per Module	12 Including 4 Configurable HSC Inputs	
Commons per Module	1	
Input Voltage Range	12VDC / 24VDC	
Absolute Max. Voltage	35VDC Max.	
Input Impedance	10kΩ	
Input Current	Positive Logic	Negative Logic
Upper Threshold	0.8mA	-1.6mA
Lower Threshold	0.3mA	-2.1mA
Max. Upper Threshold	8VDC	
Min. Lower Threshold	3VDC	
OFF to ON Response	1ms	
ON to OFF Response	1ms	
High Speed Counter Max Freq*	1MHz	

*See I/O info below for detail regarding HSC and PWM

1.8 Digital DC Outputs

Outputs per Module	16 Including 2 Configurable PWM Outputs
Commons per Module	1
Output Type	Sourcing / 10kΩ Pull-Down
Output Frequency	500kHz
Absolute Max. Voltage	28VDC Max.
Output Protection	Short Circuit
Max. Output Current/Point	0.5A
Max. Total Current	4A Continuous
Max. Output Supply Voltage	30VDC
Min. Output Supply Voltage	10VDC
Max. Voltage Drop at Rated Current	0.25VDC
Max. Inrush Current	650mA per Channel
Min. Load	None
OFF to ON Response	1ms
ON to OFF Response	1ms
Output Characteristics	Current Sourcing (Pos. Logic)
PWM Out	≈ 5kHz
Rise Time	50 - 115μs
Fall Time	8-20μs

1.9 Analog Inputs, High Resolution

Number of Channels	2	Thermocouple: B / R / S E T J K / N	Temperature Range: 32°F to 2,912°F (0°C to 1,600°C) -328°F to 1,652°F (-200°C to 900°C) -400°F to 752°F (-240°C to 400°C) -346°F to 1,382°F (-210°C to 750°C) -400°F to 2,498°F (-240°C to 1,370°C)
Input Ranges (Selectable)	0-10VDC; 0-20mA; 4-20mA; 100mV PT100; and J, K, N, T, E, R, S, B Thermocouples	Thermocouple Common Mode Range	+/- 10V
Safe Input Voltage Range	10VDC: -0.5V to +15V 20mA: -0.5V to +6V RTD / T/C: +/- 24VDC	Converter Type	Delta Sigma
Nominal Resolution	10V, 20mA, 100mV: 14 Bits RTD, Thermocouple: 16 Bits	Max. Error at 25°C (*excluding zero)	*4-20mA +/- 0.10% of full scale *0-20mA +/- 0.10% of full scale *0-10VDC +/- 0.10% of full scale RTD (PT100) +/- 1.0 C° of full scale 0-100mV +/- 0.05% of full scale (*excluding zero)
Input Impedance (Clamped @ -0.5 Vdc to 12 Vdc)	Current Mode: 100Ω, 35mA Max. Continuous Voltage Mode: 500kΩ, 25mA Max. Continuous	Max. Thermocouple Error (After Warm up Time of One Hour)	+/-0.2% (+/-0.3% below -100°C) of full scale
%AI Full Scale	10V, 20mA, 100mV: 32,000 counts full scale RTD / T/C: 20 Counts / °C	Conversion Speed, Both Channels Converted	10V, 20mA, 100mV: 30 Times/Second RTD Thermocouple: 7.5 Times/Second
Max. Over-Current	35mA	Conversion Time per Channel	10V, 20mA, 100mV: 16.7 ms RTD, Thermocouple: 66.7 ms
Open Thermocouple Detec Current	50nA	RTD Excitation Current	250μA

1.10 Analog Outputs

Number of Channels	2	Minimum 10V Load	1kΩ
Output Ranges	0-10VDC , 0-20mA	Minimum Resistance Load	500Ω
Nominal Resolution	12 Bits	Analog Outputs; Output Points Required	2
Update Rate	Once per PLC scan	Addnl. Error for Temp. Other Than 25°C	20mA 0.000143%/ °C 0 - 10V 0.000151%/ °C
Max. Error at 25°C (Excluding Zero)	20mA 0.1% of full scale 0 - 10V 0.1% of full scale		

2 CONTROLLER OVERVIEW

2.1 - Overview of XL4



1. Touchscreen
2. Function Keys
3. High Capacity microSD Slot
4. Configuration Switchest
5. USB Mini-B Port
6. Wide-Range DC Power
7. CAN Port
8. Ethernet LAN Port
9. USB A Port
10. RS232/RS485 Serial Port

2.2 - Power Wiring

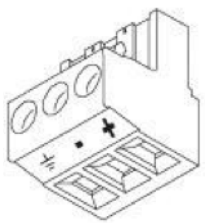

Primary Power Port Pins		
PIN	SIGNAL	DESCRIPTION
1	Ground	Frame Ground
2	DC-	Input Power Supply Ground
3	DC+	Input Power Supply Voltage

DC Input / Frame
 Solid/Stranded wire; 12-24 awg (2.5-0.2mm).
 Strip length - 0.28" (7mm).
 Torque rating: 4.5 - 7 in-lbs (0.50 - 0.78 N-m).
 DC- is internally connected to I/O V-, but is isolated from CAN V-.
 A Class 2 power supply must be used.

3 WIRING: INPUTS AND OUTPUTS

3.1 - Digital Input & Output Information

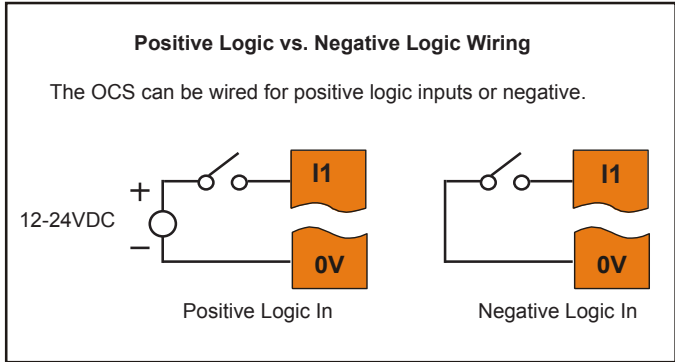

DIGITAL INPUTS
 Digital inputs may be wired in either a Positive Logic or Negative Logic fashion as shown. The setting in the Cscape Hardware Configuration for the Digital Inputs must match the wiring used in order for the correct input states to be registered. When used as a normal input and not for high speed functions, the state of the input is reflected in registers %I1 - %I12.

Digital inputs may alternately be specified for use with High Speed Counter functions, also found in the Hardware Configuration for Digital Inputs. Refer to the XL4 User Manual [MAN0964] for full details.

XL4 User Manual [MAN0964]
 The User Manual includes extensive information on:

- Built-in I/O
- Common %S & %SR Registers
- HSC/PWM/Totalizer/Quadrature & Accumulator Registers
- Resource Limits

Wiring Details:
 Solid/Stranded wire - 12-24 awg (2.5-0.2 mm²).
 Strip length - 0.28" (7 mm).
 Torque rating: 4.5 - 7 in-lbs (0.50 - 0.78 N-m).

wiring: I-O continued...

3.2 - Analog Input Information

ANALOG INPUTS

Raw input values for channels 1-4 are found in the registers as Integer-type data with a range from 0 - 32000.

Analog inputs may be filtered digitally with the Filter Constant found in the Cscape Hardware Configuration for Analog Inputs. Valid filter values are 0 - 7 and act according to the following chart.

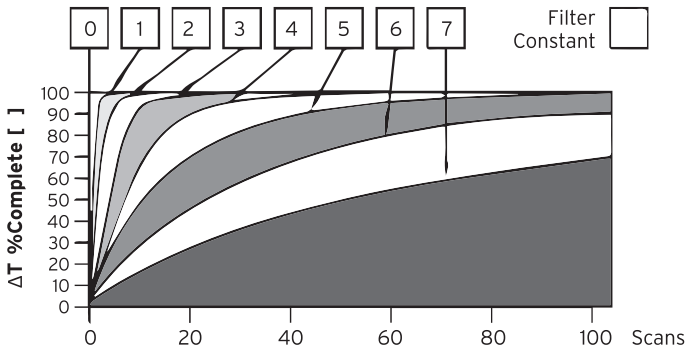

3.4 - Digital In & Out Wiring

J1 Specifications

J1 (Orange) Positive Logic Digital Inputs

J1 (Orange) Name	
I1	IN1
I2	IN2
I3	IN3
I4	IN4
I5	IN5
I6	IN6
I7	IN7
I8	IN8
H1	HSC1 / IN9
H2	HSC2 / IN10
H3	HSC3 / IN11
H4	HSC4 / IN12
NC	No Connect
NC	No Connect
OV	Common

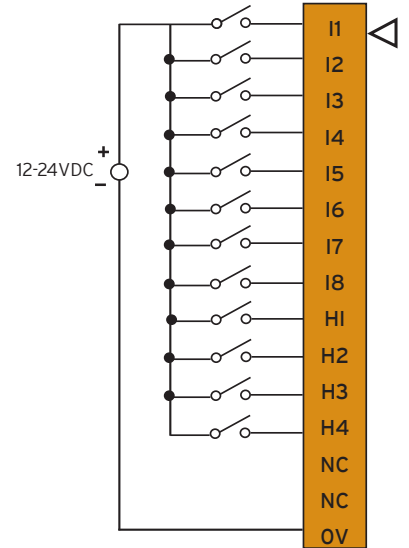

3.3- Jumper Setting Details

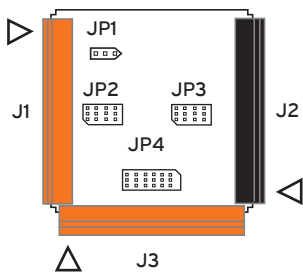

Location of I/O jumpers (JP1 - JP4) and wiring connectors (J1 - J3) with back cover removed.

JP2 & J3 Analog Input Settings

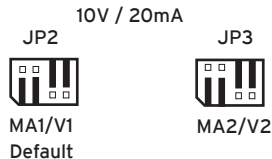
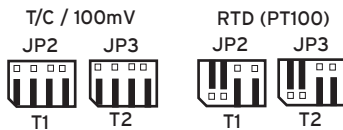

JP4 Analog Output Setting Voltage or Current

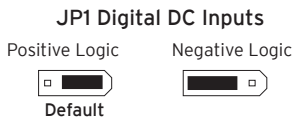
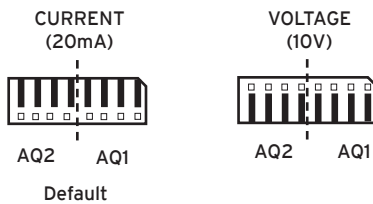

J2 Specifications

J2 (Black) Positive Logic Digital Outputs

J2 (Black) Name	
OV	Common
V+	V+
NC	No Connect
Q12	OUT 12
Q11	OUT 11
Q10	OUT 10
Q9	OUT 9
Q8	OUT 8
Q7	OUT 7
Q6	OUT 6
Q5	OUT 5
Q4	OUT 4
Q3	OUT 3
Q2	OUT2/PWM2
Q1	OUT1/PWM1

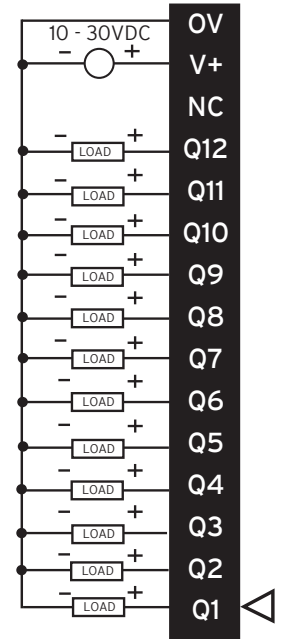

wiring: I-O continued...

J3 Specifications

J3 (Orange) Name

T1+	TC (1+) or RTD (1+) or 100 mV (1+)
T1-	TC (1-) or RTD (1-) or 100 mV (1-)
T2+	TC (2+) or RTD (2+) or 100 mV (2+)
T2-	TC (2-) or RTD (2-) or 100 mV (2-)
AQ1	10 V or 20 mA OUT (1)
AQ2	10 V or 20 mA OUT (2)
OV	Common
MA1	0-20 mA IN (1)
V1	0-10 V IN (1)
OV	Common
MA2	0-20 mA IN (2)
V2	0-10 V IN (2)
OV	Common

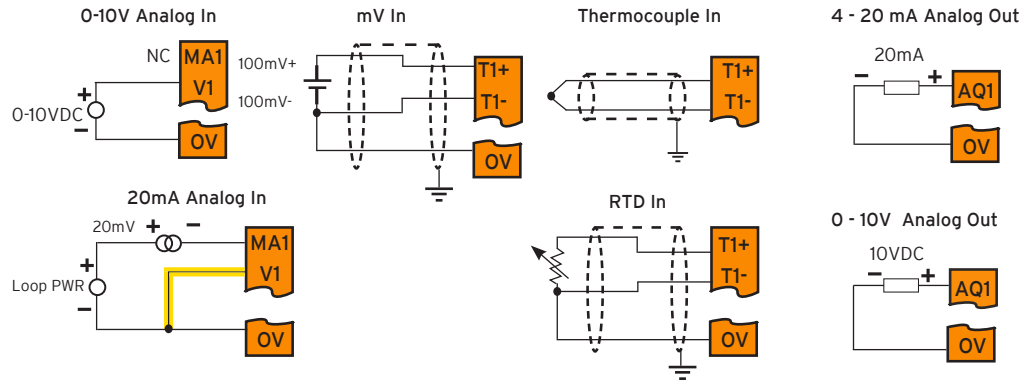

NOTE: Loop power requirements are determined by the transmitter specification.
NOTE: Be sure to wire OV to V1 as shown for proper operation.

4 COMMUNICATIONS

4.1 - CAN Communications

CAN Pin Assignments

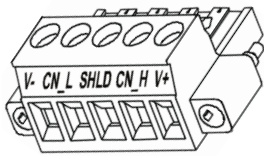

PIN	SIGNAL	DESCRIPTION
1	V-	CAN Ground - Black
2	CN L	CAN Data Low - Blue
3	SHLD	Shield Ground - None
4	CN H	CAN Data High - White
5	V+ (NC)	No Connect - Red

CAN

Solid/Stranded wire: 12-24 awg (2.5-0.2mm)
Strip length: 0.28" (7mm).
Locking spring-clamp, two-terminators per conductor.
Torque Rating: 4.5 in-lbs (0.50 N-m).
V+ pin is not internally connected, the SHLD pin is connected to Earth ground via a 1 MΩ resistor and 10nF capacitor.

4.2 - Serial Communications

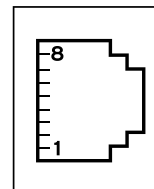

MJ1/2 SERIAL PORTS

Two Serial Ports on One Module Jack (8posn)

MJ1: RS-232 w/Full Handshaking

MJ2: RS-232 Half-Duplex

MJ1 PINS			MJ2 PINS	
PIN	SIGNAL	DIRECTION	SIGNAL	DIRECTION
8	TXD	OUT	--	--
7	RXD	IN	--	--
6	OV	GROUND	OV	GROUND
5	+5V @ 60mA	OUT	+5V @ 60mA	OUT
4	RTS	OUT	--	--
3	CTS	IN	--	--
2	--	--	RX- / TX-	IN / OUT
1	--	--	RX+ / TX+	IN / OUT

communications continued...

4.3 - Dip Switches

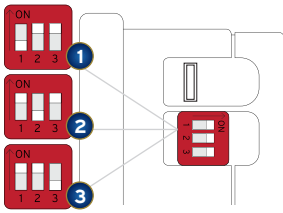

The DIP switches are used to provide a built-in termination to the MJ2 port if needed. The termination for these ports should only be used if this device is located at either end of the multidrop/daisy-chained RS-485 network.

DIP SWITCHES

PIN	NAME	FUNCTION	DEFAULT
1	MJ1 RS-485 Termination	ON = Terminated	OFF
2	Spare	Always OFF	OFF
3	Factory Use	Always OFF	OFF

4.4 - Ethernet Communications

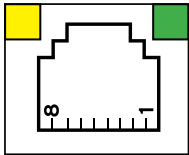

Green LED indicates link - when illuminated, data communication is available.
 Yellow LED indicates activity - when flashing, data is in transmission.

5 BUILT-IN I/O

Built-in I/O (XL4, Model 5)

All XL4 models (except the Model 0) feature built-in I/O. The I/O is mapped into OCS Register space, in three separate areas - Digital/ Analog I/O, High-Speed Counter I/O, and High-Speed Output I/O. Digital/Analog I/O location is fixed starting at 1, but the high-speed counter and high-speed output references may be mapped to any open register location. For more details, see the XL4 OCS User's Manual (MAN0964).

5.1 Digital and Analog I/O Functions

Digital Inputs	%I1-12
Reserved	%I13-31
ESCP Alarm	%I32
Digital Outputs	%Q1-12
Reserved	%Q13-24
Analog Inputs	%AI1-2
Reserved	%AI3-12
Analog Outputs	%AQ9-10
Reserved	%AQ1-8

6 INSTALLATION

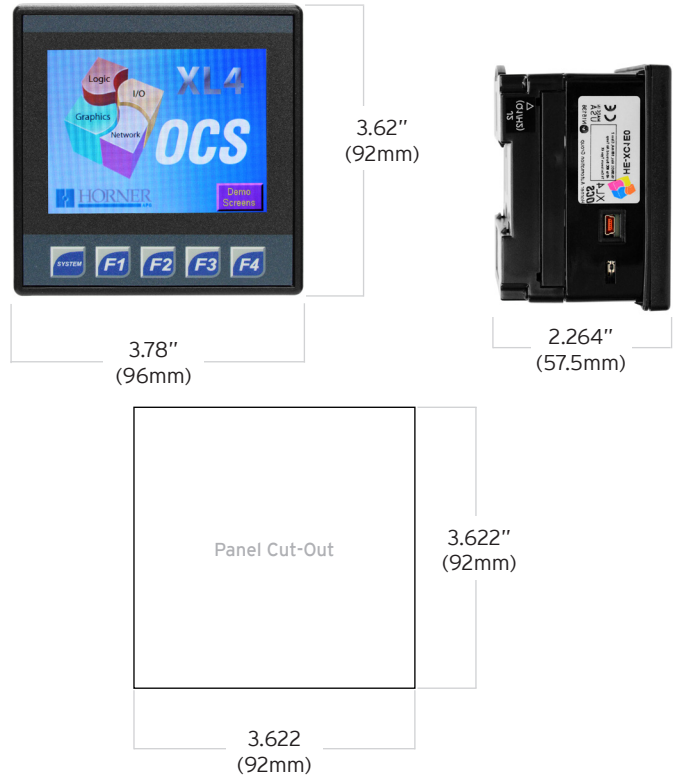

6.1 - Installation Procedure

The XL4 utilizes a clip installation method to ensure a robust and watertight seal to the enclosure. Please follow the steps below for the proper installation and operation of the unit.

- Carefully locate an appropriate place to mount the XL4. Be sure to leave enough room at the top of the unit for insertion and removal of the microSD™ card.
- Carefully cut the host panel per the diagram on Page 1, creating a 92 mm x 92 mm +/-0.1 mm opening into which the XL4 may be installed. If the opening is too large, water may leak into the enclosure, potentially damaging the unit. If the opening is too small, the OCS may not fit through the hole without damage.
- Remove any burrs and or sharp edges and ensure the panel is not warped in the cutting process.
- Remove all Removable Terminals from the XL4. Insert the XL4 through the panel cutout (from the front). The gasket must be between the host panel and the XL4T
- Install and tighten the four mounting clips (provided in the box) until the gasket forms a tight seal (max torque 0.8 to 1.13 N m, or 7-10 in-lbs).
- Reinstall the XL4 I/O Removable Terminal Blocks. Connect communications cables to the serial port, USB ports, Ethernet port, and CAN port as required.

7 SAFETY

7.1 - WARNINGS

- To avoid the risk of electric shock or burns, always connect the safety (or earth) ground before making any other connections.
- To reduce the risk of fire, electrical shock, or physical injury, it is strongly recommended to fuse the voltage measurement inputs. Be sure to locate fuses as close to the source as possible.
- Replace fuse with the same type and rating to provide protection against risk of fire and shock hazards.
- In the event of repeated failure, do NOT replace the fuse again as repeated failure indicates a defective condition that will NOT clear by replacing the fuse.
- Only qualified electrical personnel familiar with the construction and operation of this equipment and the hazards involved should install, adjust, operate, or service this equipment. Read and understand this manual and other applicable manuals in their entirety before proceeding. Failure to observe this precaution could result in severe bodily injury or loss of life.

7.2 - FCC COMPLIANCE

This device complies with Part 15 of the FCC Rules. Operation is subject to the following two conditions:

- This device may not cause harmful interference
- This device must accept any interference received, including interference that may cause undesired operation

7.3 - PRECAUTIONS

All applicable codes and standards need to be followed in the installation of this product. Adhere to the following safety precautions whenever any type of connection is made to the module:

- Connect the safety (earth) ground on the power connector first before making any other connections.
- When connecting to the electric circuits or pulse-initiating equipment, open their related breakers.
- Do NOT make connection to live power lines.
- Make connections to the module first; then connect to the circuit to be monitored.
- Route power wires in a safe manner in accordance with good practice and local codes.
- Wear proper personal protective equipment including safety glasses and insulated gloves when making connections to power circuits.
- Ensure hands, shoes, and floor are dry before making any connection to a power line.
- Make sure the unit is turned OFF before making connection to terminals.
- Make sure all circuits are de-energized before making connections.
- Before each use, inspect all cables for breaks or cracks in the insulation. Replace immediately if defective.
- Use copper conductors in Field Wiring only, 60/75°C.

8 ANALOG IN TRANZORB FAILURE

A common cause of Analog Input Tranzorb Failure on Analog Inputs Model 2, 3, 4 & 5: If a 4- 20mA circuit is initially wired with loop power, but without a load, the Analog input could see 24VDC. This is higher than the rating of the tranzorb. This can be solved by NOT connecting loop power prior to load connection, or by installing a low-cost PTC in series between the load and analog input.

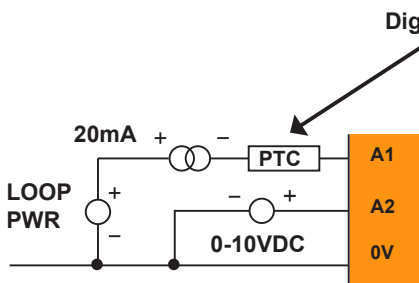

9 BATTERY

The XL4 has an advanced battery system that uses a rechargeable lithium battery. The battery powers the real time clock when power is removed, and it is needed for register data retention. Please reference the XL4 User Manual [MAN0964] which provides instructions on how to replace the battery.

10 TECHNICAL SUPPORT

For assistance and manual updates, contact Technical Support at the following locations:

North America
 (317) 916-4274
www.hornerautomation.com
techsppt@heapg.com

Europe
 (+) 353-21-4321-266
www.horner-apg.com
technical.support@horner-apg.com

11 PART NUMBER BUILDER

EXAMPLE PART NUMBERS

GLOBAL MODEL NUMBERS

	screen	Ethernet	I/O
HE-X	<input type="text"/>	<input type="text"/>	<input type="text"/>
E	(no touchscreen)	O	(no Ethernet)
T	(touchscreen)	E	(Ethernet)
		0	(model 0)
		2	(model 2)
		3	(model 3)
		4	(model 4)
		5	(model 5)
		6	(model 6)

EUROPEAN MODEL NUMBERS

	screen	Ethernet	CAN option	I/O	overlay type	
HEX	<input type="text"/>	<input type="text"/>	<input type="text"/>	<input type="text"/>	<input type="text"/>	
E22	(no touchscreen)	0	(no Ethernet)	0	(no CAN*)	
T24	(touchscreen)	1	(Ethernet)	1	(CsCAN)	
			2	(CANopen)	12	(model 2)
			4	(DeviceNet)	13	(model 3)
			5	(J1939)	14	(model 4)
				15	(model 5)	
				16	(model 6)	
					00	(dark colour)
					01	(light colour)
					02	(blank)
					03-99	(custom)