



# XL10W Prime Datasheet - Model 3

12 DC In, 12 DC Out, 2 – 12-bit Analog In

MAN1512\_00\_EN\_XL10WP\_Mod3



HG-1260

**Part Number: HE-X10PE3**

## User Manual and Add-Ons

Find the documents via the [Documentation Search](#).

Part #	Description
MAN1485	XL10W Prime User Manual
HE-BAT013	Packaged lithium coin cell battery
HE-XCK	Programming Cable Kit
HE-PRGA2C	USB-A to USB-C programming cable
HE-PRGC2C	USB-C to USB-C programming cable
HE-XDAC007	2 channel Analog Output I/O option kit, selectable 0-10V, $\pm 10V$ , 4-20mA.
HE-XDAC107	4 channel Analog Output I/O option kit, selectable 0-10V, $\pm 10V$ , 4-20mA.
HE200MJ2TRM	Adapter, RJ45 (8P8C) male to 8-position terminal strip.
HE-FBD001	Ferrite core for filtering out electrical noise.

## Battery Maintenance

The XL10W Prime uses a packaged lithium coin cell battery to run the Real Time Clock. The battery life is 7-10 years.

For more information, see **MAN1509**.

## Table of Contents

User Manual and Add-Ons .....	1
Battery Maintenance .....	1
<b>TECHNICAL SPECIFICATIONS .....</b>	<b>2</b>
General Specifications .....	2
Backlight .....	2
Control and Logic .....	3
User Interface .....	3
Connectivity .....	3
USB Webcams .....	4
<b>CONTROLLER OVERVIEW .....</b>	<b>5</b>
Overview of the XL10W Prime OCS .....	5
Power Wiring .....	6
<b>MODEL 3 SPECIFICATIONS .....</b>	<b>7</b>
Digital DC Input .....	7
Digital DC Outputs .....	7
Analog Inputs .....	8
<b>WIRING: INPUTS AND OUTPUTS .....</b>	<b>9</b>
Analog Inputs Information .....	9
Digital Inputs .....	9
Positive Logic vs. Negative Logic .....	9
Jumper Settings for Model 3 .....	10
Screw Torque for Reattaching Back Cover After I/O	
Jumper Update .....	10
J1 (Orange) Wiring - Digital In/Analog In .....	11
J2 (Black) Wiring - Digital Out .....	12
Built-In I/O .....	13
Wiring Details .....	13
Analog Input Transient-Voltage-Suppression Diode	
Failure .....	13
<b>COMMUNICATIONS .....</b>	<b>14</b>
Serial Communication .....	14
Ethernet .....	14
DIP Switches .....	15
CAN Communications .....	15
<b>DIMENSIONS &amp; INSTALLATION .....</b>	<b>16</b>
XL10W Prime .....	16
Installation Information .....	17
Installation Procedure .....	17
<b>SAFETY &amp; MAINTENANCE .....</b>	<b>18</b>
Warnings .....	18
FCC Compliance .....	18
Precautions .....	18

## TECHNICAL SPECIFICATIONS

### General Specifications

Inrush Current	25A for < 1ms @ 24VDC, DC switched
Primary Voltage Range	10 - 30VDC
Maximum Current	1100mA, Class 2
Clock Accuracy	± 20 ppm maximum at 25°C (±1 min/month)
Real Time Clock	Battery Backed, Lithium Coin
Operating Temperature	-10°C to +60°C
Storage Temperature	-20°C to +60°C
Relative Humidity	5 to 95%, Non-Condensing
Weight	2.7 lbs.
Altitude	Up to 2000m
Rated Pollution Degree	Degree 2 Rating
Certifications (UL/CE)	<a href="#">North America</a> or <a href="#">Europe</a>
Enclosure Type	1, 3R, 4, 4X, 12, 12K & 13

### Backlight

HE-X10PE0 (Model 0)	Typical Power Backlight at 100%	870mA@10V(8.7W);379mA@24VDC(9.096W)
	Power Backlight at 50%	224mA@24VDC(5.38W)
	Power Backlight Off	214mA@24VDC(5.14W)
HE-X10PE2 (Model 2)	Typical Power Backlight at 100%	1001mA@10V(10.01W);436mA@24VDC(10.464W)
	Power Backlight at 50%	281mA@24VDC(6.74W)
	Power Backlight Off	271mA@24VDC(6.50W)
HE-X10PE3 (Model 3)	Typical Power Backlight at 100%	898mA@10V(8.98W);431mA@24VDC(10.344W)
	Power Backlight at 50%	276mA@24VDC(6.62W)
	Power Backlight Off	266mA@24VDC(6.38W)
HE-X10PE4 (Model 4)	Typical Power Backlight at 100%	907mA@10V(9.07W);447mA@24VDC(10.728W)
	Power Backlight at 50%	292mA@24VDC(7.01W)
	Power Backlight Off	282mA@24VDC(6.77W)
HE-X10PE5 (Model 5)	Typical Power Backlight at 100%	1073mA@10V(10.73W);497mA@24VDC(11.928W)
	Power Backlight at 50%	342mA@24VDC(8.21W)
	Power Backlight Off	332mA@24VDC(7.97W)
HE-X10PE6 (Model 6)	Typical Power Backlight at 100%	1057mA@10V(10.57W);465mA@24VDC(11.16W)
	Power Backlight at 50%	310mA@24VDC(7.44W)
	Power Backlight Off	300mA@24VDC(7.20W)

## Control and Logic

Control Language Support	Register-Based Advanced Ladder Logic; Variable-Based Advanced Ladder; IEC 61131-3 Languages
Logic Program Size	2MB, maximum
Scan Rate	0.02ms/kB
Digital Inputs	2048
Digital Outputs	2048
Analog Inputs	512
Analog Outputs	512
General Purpose Registers	50,000 (words) Retentive 16,384 (bits) Retentive 16,384 (bits) Non-retentive

## User Interface

Display Type	10.1" 65k Color; 300 cd/m <sup>2</sup> (nits)
Resolution	1024x600 pixels
Backlight Type	White LED
Backlight Lifetime	50,000 hrs to reach 50% brightness
Backlight Control	0-100% by system register %SR57
User-Programmable Screens / Pages	1023
Number of Objects / Screens	1023
Screen Memory	17MB
Keypad	Touch screen
Tactile Feedback	Optional Sound
Number of Keys	System, seven function keys, and hide key

## Connectivity

Serial Ports	1 RS-232 & 1 RS-485 on first Modular Jack (MJ1/2); 1 RS-232 or 1 RS-485 on second Modular Jack (MJ3)
USB C	PD Capable Port Required for USB-C Power. USB 2.0 (480Mbps) Programming & Data Access, & Device Power
USB A (1000mA max)	USB 2.0 (480Mbps) for USB flash drives (≤2TB)
CAN Port (Independently Isolated)	Remote I/O, Peer-to-peer Comms, Cscape
CAN Protocols	CsCAN, CANopen, DeviceNet, J1939
Ethernet	Two 10/100 Mbps, Auto-MDX
Ethernet Protocols	TCP/IP, Modbus TCP, FTP, SMTP, EGD, ICMP, ASCII
Remote I/O	SmartRail, SmartStix, SmartBlock, SmartMod, OCS-I/O
Removable Memory	microSD, SDHC, SDXC (Formatted as FAT32)
Maximum Capacity	Support for 32GB max.
Removable Media	Application Updates, Firmware Updates, and Datalogging
Audio	Line out and microphone in



## **USB Webcams**

USB Webcams supported should support the UVC (USB Video class) protocol for the OCS to be able to display video. Most USB based video devices support this today. Special features such as zoom and high definition are not supported by the OCS.

## CONTROLLER OVERVIEW

### Overview of the XL10W Prime OCS



HG-1262

<ul style="list-style-type: none"> <li>1. Touchscreen</li> <li>2. microSD: Data Storage</li> <li>3. USB Type C 2.0 Port</li> <li>4. CAN 2 Port</li> <li>5. MJ1/2 Port</li> <li>6. DIP Switches</li> <li>7. MJ3 Port</li> <li>8. CAN 1 Port</li> </ul>	<ul style="list-style-type: none"> <li>9. Power In</li> <li>10. LAN2 Port</li> <li>11. LAN1 Port</li> <li>12. Audio Line Out/Mic In</li> <li>13. USB Type A 2.0 Port</li> <li>14. OCS-I/O Port (for future support)</li> </ul>
---	--

**NOTE:** Use caution when connecting controllers to PCs via serial or USB. PCs, especially laptops may use “floating power supplies” that are ungrounded. This could cause a damaging voltage potential between the laptop and controller. Ensure the controller and laptop are grounded for maximum protection. Consider using a USB isolator due to voltage potential differences as a preventative measure.

## Power Wiring

**NOTE:** The Primary Power Range is 10VDC to 30VDC.

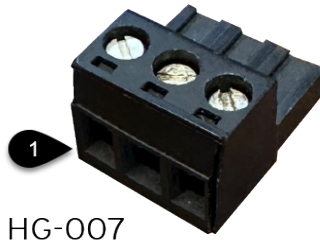

HG-007

Primary Power Port Pins		
PIN	Signal	Description
1	Ground	Frame Ground
2	DC-	Input Power Supply Ground
3	DC+	Input Power Supply Voltage

### DC Input/Frame

- Solid/Stranded Wire: 12-24 AWG (2.5-0.2mm<sup>2</sup>)
- Strip length: 0.28" (7mm)
- Torque, Terminal Hold-Down Screws: 4.5 – 7 in•lbs (0.50 – 0.78 N•m)
- DC- is internally connected to I/O V-, but is isolated from either CAN V-. A Class 2 power supply must be used.

### Power UP

1. **OPTION:** Attach ferrite core with a minimum of two turns of the DC+ and DC- signals from the DC supply that is powering the controllers.

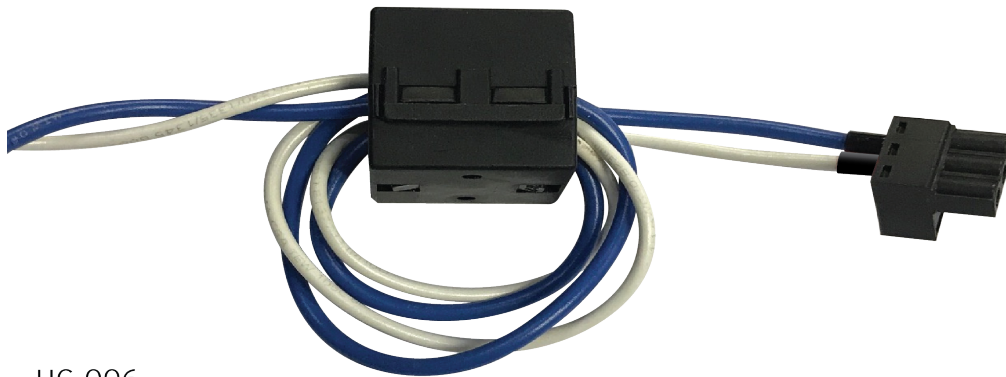

HG-006

2. Connect to earth ground.
3. Apply recommended power.

## MODEL 3 SPECIFICATIONS

### Digital DC Input

Inputs per Module	12 Including 4 Configurable HSC Inputs	
Commons per Module	1	
Input Voltage Range	12VDC/24VDC	
Absolute Maximum Voltage	30VDC	
Input Impedance	10k $\Omega$	
Input Current	Positive Logic	Negative Logic
Upper Threshold	0.8mA	-1.6mA
Lower Threshold	0.3mA	-2.1mA
Maximum Upper Threshold	8VDC	
Minimum Lower Threshold	3VDC	
OFF to ON Response	1ms	
ON to OFF Response	1ms	
High Speed Counter Maximum Frequency	1MHz (Quadrature Frequency 500kHz)	

### Digital DC Outputs

Outputs per Module	12 Including 2 Configurable PWM Outputs	
Commons per Module	1	
Output Type	Sourcing/10k $\Omega$ Pull-Down	
Output Frequency	10kHz (up to 500kHz when using the HE-XHSQ add-on module)	
Absolute Maximum Voltage	28VDC	
Output Protection	Short Circuit	
Maximum Output Current/Point	0.5A	
Maximum Total Current	4A Continuous	
Maximum Output Supply Voltage	30VDC	
Minimum Output Supply Voltage	10VDC	
Maximum Voltage Drop at Rated Current	0.25VDC	
Maximum Inrush Current	650mA per Channel	
Minimum Load	None	
OFF to ON Response	1ms	
ON to OFF Response	1ms	
Output Characteristics	Current Sourcing (Positive Logic)	
Rise Time	50 - 115 $\mu$ s	
Fall Time	8-20 $\mu$ s	

## Analog Inputs

Number of Channels	2
Input Ranges	0 – 10VDC; 0 – 20mA; 4 – 20mA
Safe Input Range	-0.5V to +12V
Input Impedance (Clamped @ -0.5 VDC to 12 VDC)	Current Mode: 100Ω Voltage Mode: 500kΩ
Nominal Resolution	12 Bits
%AI full scale	10V, 20mA: 32,000 counts full scale
Maximum Over-Current	35mA
Conversion Speed	All channels converted once per ladder scan
Maximum Error @ 25°C (excluding zero)	4-20mA 1.00% 0-20mA 1.00% 0-10VDC 0.50%
Filtering	160Hz hash (noise) filter 1-128 scan digital running average filter



# WIRING: INPUTS AND OUTPUTS

## Analog Inputs Information

Raw input values for channels 1-4 are found in the registers as Integer-type data with a range from 0 – 32000. Analog inputs may be filtered digitally with the Filter Constant found in the Cscape Hardware Configuration for Analog Inputs. Valid filter values are 0-7 and act according to the following chart:

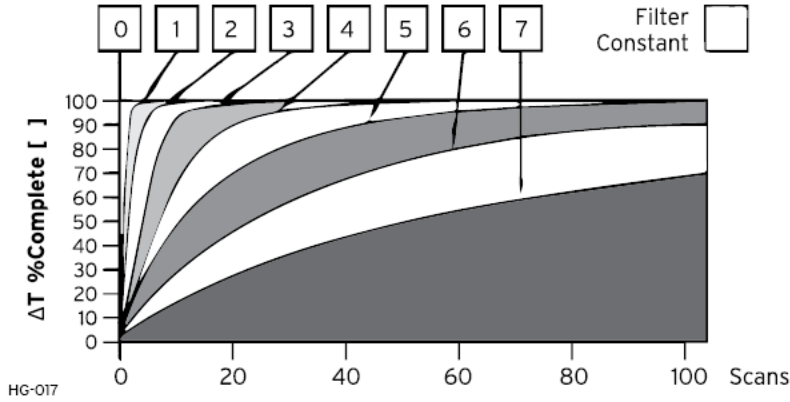

Data Values	
Input Mode:	Data Format, 12-bit INT:
0-20mA, 4-20mA	0-32000
0-10V	0-32000

## Digital Inputs

### Positive Logic vs. Negative Logic

The OCS can be wired for positive logic inputs or negative

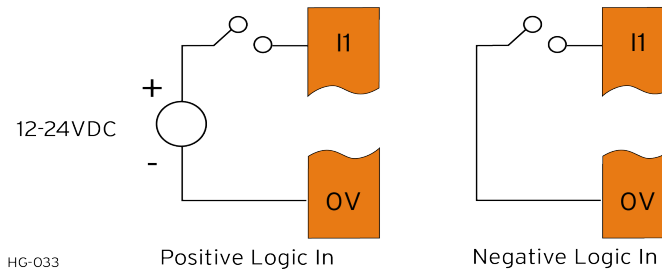

Digital inputs may be wired in either a Positive Logic or Negative Logic fashion as shown. The setting in the Cscape Hardware Configuration for the Digital Inputs must match the wiring used and JP1 jumper position in order for the correct input states to be registered. When used as a normal input and not for high speed functions, the state of the input is reflected in registers %I1 – %I12.

## Jumper Settings for Model 3

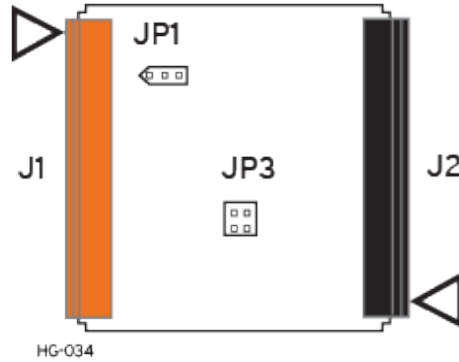

Location of I/O jumpers (JP1 & JP3) and wiring connectors (J1, J2, J3 & J4) with back cover removed.

### JP1 Digital DC Inputs

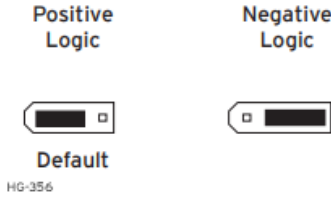

### JP3 Analog In

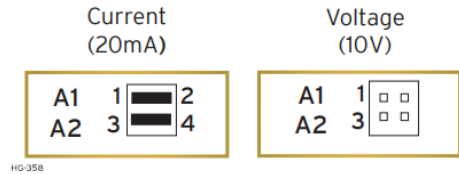

**NOTE:** The Cscape Module Configuration must match the selected I/O (JP) jumper settings.

**NOTE:** When using JP3 (A1-A2), each channel can be independently configured.

## Screw Torque for Reattaching Back Cover After I/O Jumper Update

XLE/XLT, XL4/XL4 Prime, EXL6/XL6 Prime, Canvas 4	3.0 - 4.0 in•lbs (0.34 - 0.45 N•m)
XL 15Prime, EXLW/ XLW Prime, XL15 Prime, XL7/XL7 Prime, EXL10/XL10 Prime, Canvas 7, Canvas 7D, Canvas 10D	3.0 - 3.5 in•lbs (0.34 - 0.40 N•m)

# J1 (Orange) Wiring - Digital In/Analog In

Pin	Signal Name
I1 (%I1)	Digital In 1
I2 (%I2)	Digital In 2
I3 (%I3)	Digital In 3
I4 (%I4)	Digital In 4
I5 (%I5)	Digital In 5
I6 (%I6)	Digital In 6
I7 (%I7)	Digital In 7
I8 (%I8)	Digital In 8
H1 (%I9)	HSC1/Digital In. 9
H2 (%I10)	HSC2/Digital In. 10
H3 (%I11)	HSC3/Digital In. 11
H4 (%I12)	HSC4/Digital In. 12
A1 (%AI1)	Analog In 1
A2 (%AI2)	Analog In 2
OV	Common

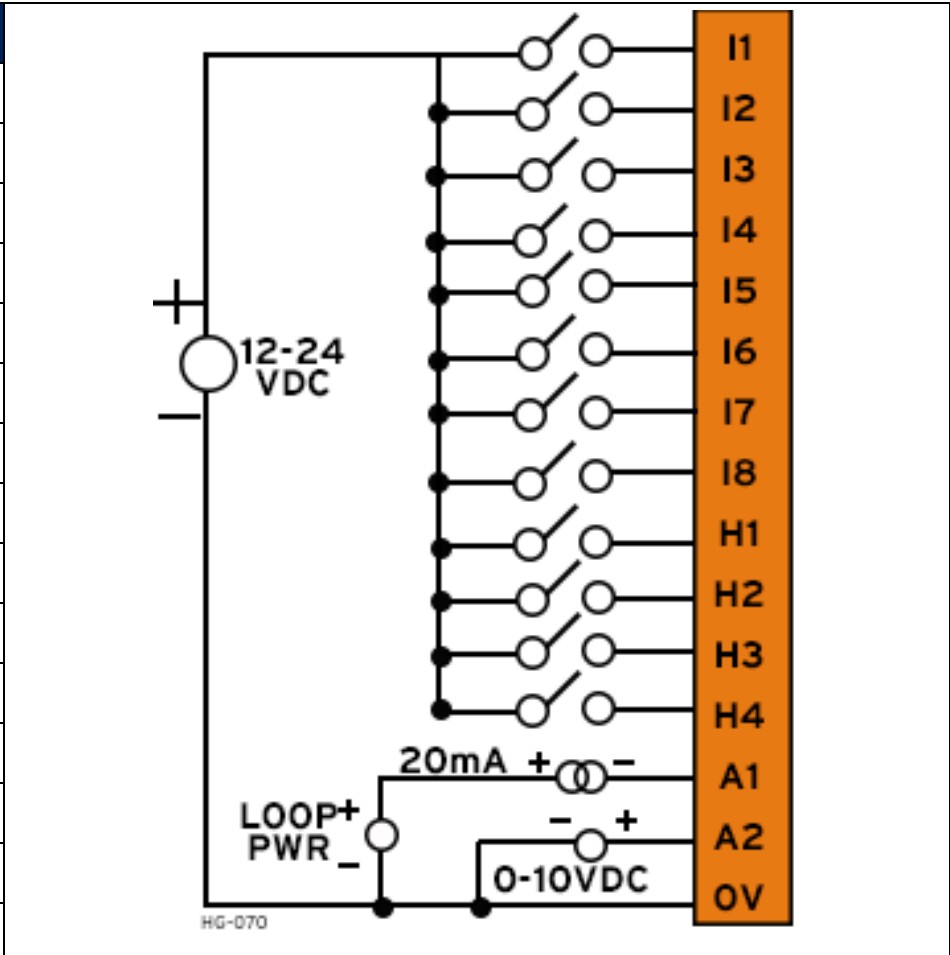

**20mA Analog In - Not Self-Powered**

HG-222

**20mA Analog In - Self-Powered**

HG-221

**0-10VDC IN**

HG-355

## J2 (Black) Wiring - Digital Out

Pin	Signal Name
0V	Common
V+	V+
NC	No Connect
Q12 (%Q12)	Digital Out 12
Q11 (%Q11)	Digital Out 11
Q10 (%Q10)	Digital Out 10
Q9 (%Q9)	Digital Out 9
Q8 (%Q8)	Digital Out 8
Q7 (%Q7)	Digital Out 7
Q6 (%Q6)	Digital Out 6
Q5 (%Q5)	Digital Out 5
Q4 (%Q4)	Digital Out 4
Q3 (%Q3)	Digital Out 3
Q2 (%Q2)	Digital Out/PWM2
Q1 (%Q1)	Dig. Out/PWM1

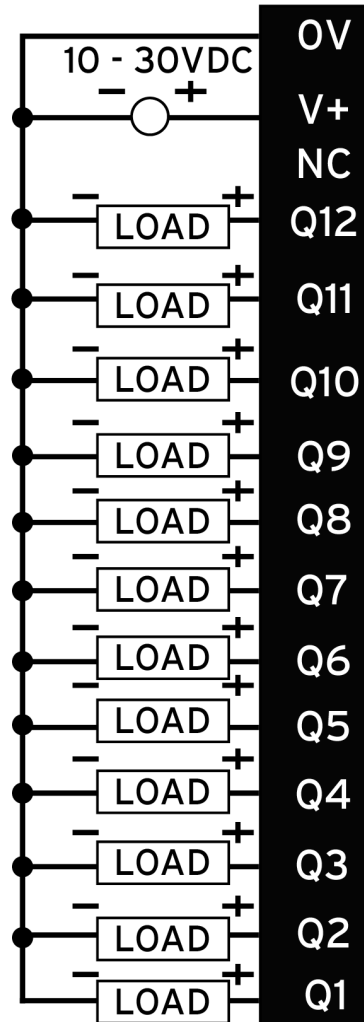

HG-072

## Built-In I/O

The I/O is mapped into OCS Register space, in three separate areas: Digital/Analog I/O, High-Speed Counter I/O, and High-speed Output I/O. Digital/Analog I/O location is fixed starting at 1, but the high-speed counter and high-speed output references may be mapped to any open register location.

Digital and Analog I/O Function Registers	
Digital Inputs	%I1-12
Reserved	%I13-31
ESCP Alarm	%I32
Digital Outputs	%Q1-12
Reserved	%Q13-24
Analog Inputs	%AI1-2
Reserved	%AI3-12
Analog Outputs	n/a
Reserved	%AQ1-8

## Wiring Details

**Solid/Stranded Wire:** 12-24 AWG (2.5-0.2mm<sup>2</sup>).

**Strip Length:** 0.28" (7mm).

**Torque, Terminal Hold-Down Screws:** 4.5 – 7 in•lbs (0.50 – 0.78 N•m).

## Analog Input Transient-Voltage-Suppression Diode Failure

A common cause of Analog Input Transient-Voltage-Suppression Diode Failure on Analog Inputs Model 2, 3, 4 & 5: If a 4- 20mA circuit is initially wired with loop power, but without a load, the analog input could see 24VDC. This is higher than the rating of the Transient-Voltage-Suppression Diode. This can be solved by NOT connecting loop power prior to load connection, or by installing a low-cost PTC in series between the load and analog input.

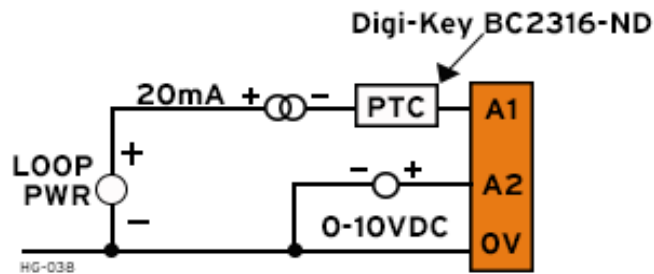

# COMMUNICATIONS

## Serial Communication

### MJ1/2 Serial Ports

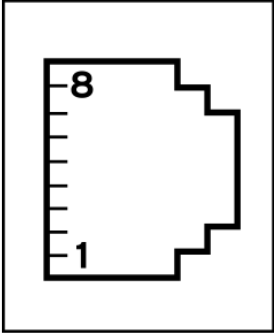
 <p>HG-008</p>	<p><b>MJ1:</b> RS-232 w/Full Handshaking  <b>MJ2:</b> RS-485 Half-Duplex</p>	MJ1 Pins		MJ2 Pins		
		PIN	SIGNAL	DIRECTION	SIGNAL	DIRECTION
		8	TXD	OUT	--	--
		7	RXD	IN	--	--
		6	0V	COMMON	0V	COMMON
		5	+5V @ 60mA	OUT	+5V @ 60mA	OUT
		4	RTS	OUT	--	--
		3	CTS	IN	--	--
		2	--	--	RX-/TX-	IN/OUT
		1	--	--	RX+/TX+	IN/OUT

### MJ3 Serial Port

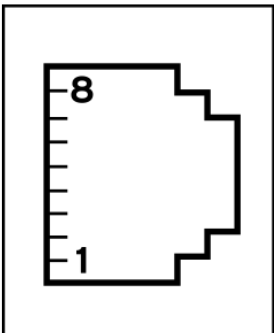
 <p>HG-008</p>	<p>2 Multiplexed Serial Ports on One Modular Jack (8 position)</p>	MJ3 PINS		
		PIN	SIGNAL	DIRECTION
		8	TXD RS-232	OUT
		7	RXD RS-232	IN
		6	0V	COMMON
		5	+5V @ 60mA	OUT
		4	TX- RS-485	OUT
		3	TX+ RS-485	OUT
		2	RX- RS-485	IN
		1	RX+ RS-485	IN

**NOTE:** Attach optional [ferrite core](#) with a minimum of two turns of serial cable.

## Ethernet

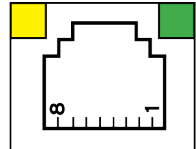
	<p><b>Green LED indicates link</b> - when illuminated, data communication is available.  <b>Yellow LED indicates activity</b> - when flashing, data is in transmission.</p>
---	---

## DIP Switches

SWITCH	DIP Switches		
	NAME	FUNCTION	DEFAULT
1	MJ3 RS-485 Termination	ON = Terminated	OFF
2	MJ3 Duplex	Both ON = Half	OFF
3		Both OFF = Full	OFF
4	MJ2 RS-485 Termination	ON = Terminated	OFF

The DIP switches are used to provide a built-in termination and duplex configuration for the modular jacks. The termination for these ports should only be used if this device is located at either end of the multidrop / daisy-chained RS-485 network.

## CAN Communications

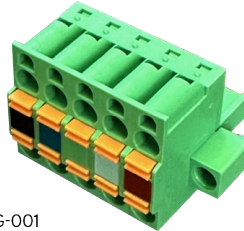

HG-001

CAN Network & Power Port Pin Assignment		
Pin	Signal	Signal Description
1	V-	CAN Ground – Black
2	CN_L	CAN Data Low – Blue
3	SHLD	Shield Ground – None
4	CN_H	CAN Data High – White
5	V+ (NC)	No Connect – Red

- **Solid/Stranded Wire:** 12-24 AWG (2.5-0.2mm<sup>2</sup>).
- **Strip Length:** 0.28" (7mm).
- Locking spring-clamp, two terminators per conductor.
- **Torque, Terminal Hold-Down Screws:** 4.5 – 7 in•lbs (0.50 – 0.78 N•m).
- V+ pin is not internally connected, the SHLD pin is connected to Earth ground via a 1MΩ resistor and 10 nF capacitor.

## DIMENSIONS & INSTALLATION

### XL10W Prime

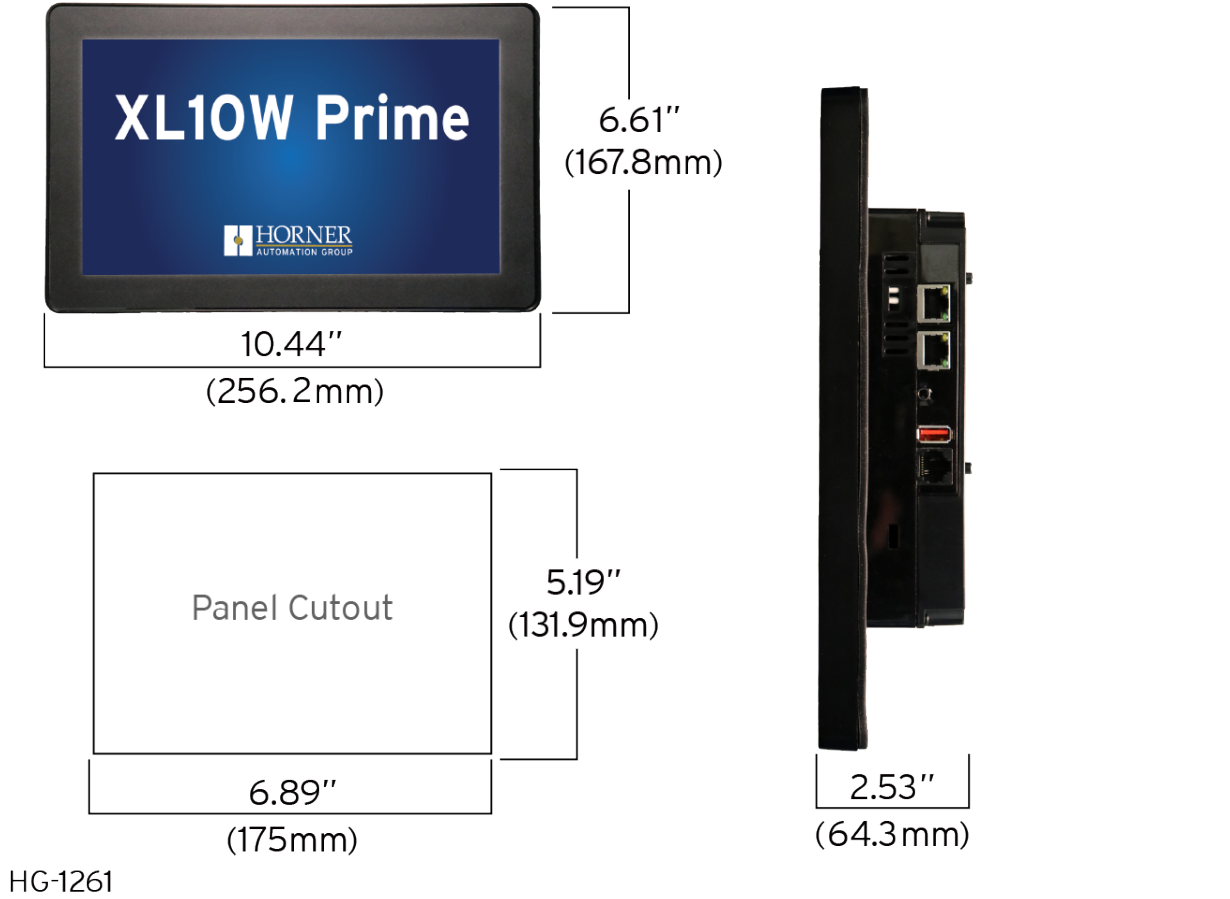

**+1.0 mm / -0 mm cutout tolerance**

**NOTE:** With the addition of an I/O module (models 2-6 only) add +0.78" (19.8mm) to the depth.



## Installation Information

- The XL10W Prime uses a clip installation method to ensure a robust and watertight seal to the enclosure. Use the following Installation Procedure steps to ensure the correct installation and operation of the unit.
- This equipment is suitable for Class I, Division 2, Groups A, B, C, and D or non-hazardous locations only.
- Digital outputs shall be supplied from the same source as the operator control station.
- Jumpers on connector JP1 must not be removed or replaced while the circuit is live unless the area is known to be free of ignitable concentrations of flammable gases or vapors.

**WARNING:** The USB ports are for operational maintenance only. Do not leave permanently connected unless area is known to be non-hazardous.

## Installation Procedure

1. Download and print the panel stud diagram from the XL10W Prime Quick Reference Guide, part number MAN1394.
2. Remove all connectors from the XL10W Prime
3. Locate an appropriate place to mount the XL10W Prime. Be sure to leave enough room for insertion and removal of the microSD card, USB flash drives, and wiring.
4. Cut the host panel per the diagram, with a tolerance of +1.0 mm / -0 mm. Remove any burrs/sharp edges and ensure the panel is not warped in the cutting process.
  - If the opening is too large, water may leak into the enclosure, potentially damaging the OCS.
  - If the opening is too small, the OCS may not fit through the hole without damage.
5. Drill holes per the panel stud diagram from the XL10W Prime Quick Reference Guide to accommodate the panel studs. Drill the holes just large enough for the panel studs to pass through.
6. Push the studs through the rubber gasket at the four indentions so that the studs can be screwed into the plastics base.
7. Install the four studs directly to the XL10W Prime unit until tight.
8. Confirm the gasket is installed on the XL10W Prime and that it is free from dust and debris. Confirm that the corners are secure, and then insert the unit into the cutout; the studs must go into their drilled holes.
9. Inserts the four mounting clips into the XL10W Prime unit. Lightly tighten each screw so that the unit is held in place.
10. Tighten the screws on each evenly so that the gasket is compressed against the wall. Recommended Torque is 7-10 in•lbs (0.79-1.13 N•m).
11. Attach the nuts to each stud and tighten until they assist in the compression. Recommended Torque is 3-4 in•lbs (0.34-.45 N•m).
12. Reconnect all previously attached connectors.

## SAFETY & MAINTENANCE

### Warnings

1. To avoid the risk of electric shock or burns, always connect the safety (or earth) ground before making any other connections.
2. To reduce the risk of fire, electrical shock, or physical injury, it is strongly recommended to fuse the voltage measurement inputs. Be sure to locate fuses as close to the source as possible.
3. Replace fuse with the same type and rating to provide protection against risk of fire and shock hazards.
4. In the event of repeated failure, do **NOT** replace the fuse again as repeated failure indicates a defective condition that will **NOT** clear by replacing the fuse.
5. Only qualified electrical personnel familiar with the construction and operation of this equipment and the hazards involved should install, adjust, operate, or service this equipment.
6. Read and understand this manual and other applicable manuals in their entirety before proceeding. Failure to observe this precaution could result in severe bodily injury or loss of life.
7. **WARNING:** Battery may explode if mistreated. Do not recharge, disassemble, or dispose of in fire.
8. **WARNING:** EXPLOSION HAZARD- Batteries must only be changed in an area known to be non-hazardous.
9. **WARNING:** Do not disconnect while circuit is live unless area is know to be non-hazardous.

### FCC Compliance

This device complies with Part 15 of the FCC Rules. Operation is subject to the following two conditions:

1. This device may not cause harmful interference.
2. This device must accept any interference received, including interference that may cause undesired operation.

### Precautions

All applicable codes and standards need to be followed in the installation of this product. Adhere to the following safety precautions whenever any type of connection is made to the module:

1. Connect the safety (earth) ground on the power connector first before making any other connections.
2. When connecting to the electric circuits or pulse-initiating equipment, open their related breakers.
3. Do NOT make connection to live power lines.
4. Make connections to the module first; then connect to the circuit to be monitored.
5. Route power wires in a safe manner in accordance with good practice and local codes.
6. Wear proper personal protective equipment including safety glasses and insulated gloves when making connections to power circuits.
7. Ensure hands, shoes, and floor are dry before making any connection to a power line.
8. Make sure the unit is turned OFF before making connections to terminals.
9. Make sure all circuits are de-energized before making connections.
10. Before each use, inspect all cables for breaks or cracks in the insulation. Replace immediately if defective.
11. Use copper conductors in field wiring only, 60/75°C.



- 12. Use caution when connecting controllers to PCs via serial or USB. PCs, especially laptops, may use “floating power supplies” that are ungrounded. This could cause a damaging voltage potential between the laptop and controller. Ensure the controller and laptop are grounded for maximum protection. Consider using a USB isolator due to voltage potential differences as a preventative measure.

## Technical Support

North America	Europe
1 (317) 916-4274 1 (877) 665-5666 <a href="http://www.hornerautomation.com">www.hornerautomation.com</a> <a href="mailto:APGUSATechSupport@heapg.com">APGUSATechSupport@heapg.com</a>	+353 (21) 4321-266 <a href="http://www.hornerautomation.eu">www.hornerautomation.eu</a> <a href="mailto:technical.support@horner-apg.com">technical.support@horner-apg.com</a>