

Canvas 7 Datasheet - Model 6

12 DC In, 12 DC Out, 17-bit Analog In (mA/V/Tc/mV/RTD), 4 – 12-bit Analog Out
MAN1382_00_EN_CV7_Mod6

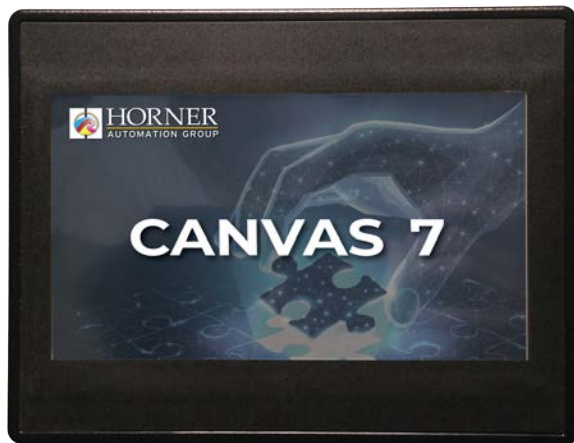

Part Number: HE-CV-070C-06

User Manual and Add-Ons

Find the documents via the [Documentation Search](#).

Part #	Description
MAN1375	Canvas 7 User Manual
MAN1142	Rechargeable Battery Manual
HE-BAT019	Rechargeable 3.6V Lithium Battery
HE-XCK	Programming Cables
HE-XDAC	2 channel Analog Output I/O option kit, selectable 0-10V, +/-10V, 4-20mA.
HE-XDAC107	4 channel Analog Output I/O option kit, selectable 0-10V, +/-10V, 4-20mA.
HE-XKIT	Blank I/O Board
HE200MJ2TRM	Adapter, RJ45 (8P8C) male to 8-position terminal strip.
HE-FBD001	Ferrite core for filtering out electrical noise.

Battery Maintenance

The Canvas 7 uses a Renata CR2032 lithium battery to run the Real Time Clock. The battery life is 7-10 years.

For more information on the battery, see **MAN1375**.

Table of Contents

Part Number: HE-CV-070C-06	1
User Manual and Add-Ons	1
Battery Maintenance	1
TECHNICAL SPECIFICATIONS	2
General Specifications	2
Backlight	2
Control and Logic	3
User Interface	3
Connectivity	3
CONTROLLER OVERVIEW	4
Power Wiring	5
MODEL 6 SPECIFICATIONS	6
Digital DC Input	6
Digital DC Outputs	7
Analog Inputs	8
Analog Outputs	9
WIRING: INPUTS AND OUTPUTS	10
Analog Inputs Information	10
Digital Inputs Information	10
Positive Logic vs. Negative Logic	10
Connector Overview	10
J1 and J2 Wiring	11
J3 Wiring	13
Status Registers	15
Registers	16
COMMUNICATIONS	17
Serial Communication	17
Ethernet	17
DIP Switches	17
CAN Communications	18
DIMENSIONS & INSTALLATION	19
Dimensions & Panel Cutout	19
Installation Information	19
Installation Procedure	20
SAFETY & MAINTENANCE	21
Warnings	21
FCC Compliance	21
Precautions	21

TECHNICAL SPECIFICATIONS

General Specifications

Required Power (Inrush)	25A for < 1ms @ 24VDC, DC switched
Primary Power Range	10 - 30VDC
Maximum Current	1000mA
Relative Humidity	5 to 95%, Non-Condensing
Clock Accuracy	± 20 ppm maximum at 25°C (± 1 min/month)
Real Time Clock	Battery Backed, Lithium Coin
Operating Temperature	-10°C to +60°C
Storage Temperature	-20°C to +60°C
Weight	63.0oz (1785g)
Altitude	Up to 2000m
Rated Pollution Degree	Degree 2 Rating
Certifications (UL/CE)	North America or Europe
Enclosure Type	1, 3R, 4, 4X, 12, 12K, & 13

Backlight

HE-CV-070C-00 (Model 0)	Typical Power Backlight at 100%	415mA@10V(4.15W);191mA@24VDC(4.584W)
	Power Backlight at 50%	111mA@24VDC(2.66W)
	Power Backlight Off	105mA@24VDC(2.52W)
HE-CV-070C-02 (Model 2)	Typical Power Backlight at 100%	546mA@10VDC(5.46W); 248mA@24VDC(5.952W)
	Power Backlight at 50%	168mA@24VDC(4.03W)
	Power Backlight Off	162mA@24VDC(3.89W)
HE-CV-070C-03 (Model 3)	Typical Power Backlight at 100%	443mA@10VDC(4.43W); 243mA@24VDC(5.832W)
	Power Backlight at 50%	163mA@24VDC(3.91W)
	Power Backlight Off	157mA@24VDC(3.77W)
HE-CV-070C-04 (Model 4)	Typical Power Backlight at 100%	452mA@10VDC(4.52W); 259mA@24VDC(6.216W)
	Power Backlight at 50%	179mA@24VDC(4.30W)
	Power Backlight Off	173mA@24VDC(4.15W)
HE-CV-070C-05 (Model 5)	Typical Power Backlight at 100%	618mA@10VDC(6.18W); 309mA@24VDC(7.416W)
	Power Backlight at 50%	229mA@24VDC(5.50W)
	Power Backlight Off	223mA@24VDC(5.35W)
HE-CV-070C-06 (Model 6)	Typical Power Backlight at 100%	602mA@10VDC(6.02W); 277mA@24VDC(6.648W)
	Power Backlight at 50%	197mA@24VDC(4.73W)
	Power Backlight Off	191mA@24VDC(4.58W)

Control and Logic

Control Language Support	Register-Based Advanced Ladder Logic; Variable-Based Advanced Ladder IEC 61131-3 Languages
Logic Program Size	2MB, maximum
Scan Rate	0.02ms/kB
Digital Inputs and Digital Outputs	2048
Analog Inputs and Analog Outputs	512
General Purpose Registers	50,000 (words) Retentive 16,384 (bits) Retentive 16,384 (bits) Non-retentive

User Interface

Display Type	7" TFT Color
Resolution	800 x 480
Color	16-bit (65,536)
Screen Brightness	420 nits
Screen Memory	17MB
User-Program. Screens	1023 max pages; 1023 objects per page
Backlight	LED - 50,000 hour life

Connectivity

Serial Ports	1 RS-232 & 1 RS-485 on first Modular Jack (MJ1/2) 1 RS-232 or 1 RS-485 on second Modular Jack (MJ3)
USB mini-B	USB 2.0 (480Kbps) Programming & Data Access
USB A (500mA max)	USB 2.0 (480Kbps) for USB flash drives (2TB), Wi-Fi, cameras, mice and keyboards
CAN Port Isolated 1kV	Remote I/O, Peer-to-peer Comms, Cscape
CAN Protocols	CsCAN, CANopen, DeviceNet, J1939
Ethernet	10/100 Mb (Auto-MDX)
Ethernet Protocols	TCP/IP, Modbus TCP, FTP, SMTP, EGD, ICMP, ASCII
Remote I/O	OCS-I/O
Removable Memory	microSD, SDHC, SDXC (in FAT32 format), support for 32GB max. Application Updates, Datalogging

USB Webcams

USB Webcams supported should support the UVC (USB Video class) protocol for the OCS to be able to display video. Most USB based video devices support this today. Special feature such as zoom and high definition are not supported by the OCS

CONTROLLER OVERVIEW



HG-745

1. Touchscreen
2. USB Type A 2.0
3. LAN Port
4. Power: 10-30VDC In
5. CAN Port
6. MJ3: RS-232/ RS-485
7. DIP Switches
8. MJ1/MJ2: RJ45 Serial Port
9. microSD: Data Storage
10. USB Type Mini B: Programming

NOTE: Use caution when connecting controllers to PCs by way of serial or USB. PCs, especially laptops may use “floating power supplies” that are ungrounded. This could cause a damaging voltage potential between the laptop and controller. Ensure the controller and laptop are grounded for maximum protection. Consider using a USB isolator due to voltage potential differences as a preventative measure.

Power Wiring

NOTE: The Primary Power Range is 10VDC to 30VDC.

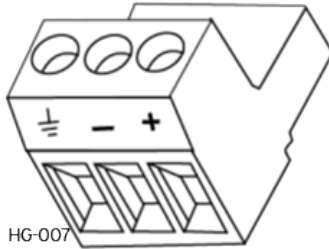

Primary Power Port Pins		
PIN	Signal	Description
1	Ground	Frame Ground
2	DC-	Input Power Supply Ground
3	DC+	Input Power Supply Voltage

DC Input / Frame

- Solid/Stranded Wire: 12-24 AWG (2.5-0.2mm²)
- Strip length: 0.28" (7mm)
- Torque, Terminal Hold-Down Screws: 4.5 – 7 in•lbs (0.50 – 0.78 N•m)
- DC- is internally connected to I/O V-, but is isolated from CAN V-. A Class 2 power supply must be used.

Power Up

1. **OPTION:** Attach ferrite core with a minimum of two turns of the DC+ and DC- signals from the DC supply that is powering the controllers.



2. Connect to earth ground.
3. Apply recommended power.



MODEL 6 SPECIFICATIONS

Digital DC Input

Inputs per Module	12 Including 4 Configurable HSC Inputs	
Commons per Module	1	
Input Voltage Range	12VDC/24VDC	
Absolute Maximum Voltage	30VDC	
Input Impedance	10k Ω	
Input Current	Positive Logic	Negative Logic
Upper Threshold	0.8mA	-1.6mA
Lower Threshold	0.3mA	-2.1mA
Maximum Upper Threshold	8VDC	
Minimum Lower Threshold	3VDC	
OFF to ON Response	1ms	
ON to OFF Response	1ms	
Galvanic Isolation	None	
Logic Polarity	Selectable in Cscope	
I/O Indication	None	
Connector Type	3.5mm Pluggable Cage Clamp Connector	
High Speed Counter Maximum Frequency	1MHz (Quadrature Frequency 500kHz)	



Digital DC Outputs

Outputs per Module	12 Including 2 Configurable PWM Outputs
Commons per Module	1
Output Type	Sourcing/10kΩ Pull-Down
Output Frequency	500kHz (up to 500kHz when using the HE-XHSQ add-on module)
Absolute Maximum Voltage	28VDC
Output Protection	Short Circuit
Maximum Output Current/Point	0.5A
Maximum Total Current	4A Continuous
Maximum Output Supply Voltage	30VDC
Minimum Output Supply Voltage	10VDC
Maximum Voltage Drop at Rated Current	0.25VDC
Maximum Inrush Current	650mA per Channel
Minimum Load	None
OFF to ON Response	1ms
ON to OFF Response	1ms
Output Characteristics	Current Sourcing (Positive Logic)
Rise Time	50 - 115μs
Fall Time	8-20μs

Analog Inputs

Number of Channels	6
Input Ranges (Selectable)	0-20mA; 4-20mA DC; 0-60mV; 0-10VDC; T/C (Ungrounded): J, K, N, T, E, R, S, B RTD: PT100, PT1000
%AI Full Scale	0-10V, 0- 20mA, 0- 100mV: 32,000 counts full scale RTD/TC: 20 counts/ °C
Nominal Resolution	17 Bits
Absolute Maximum Input Voltage	-0.5 to -12VDC (± 30VDC)
Input Impedance (Clamped @ -0.5 to 10.23VDC)	T/C/RTD/ mV > 2MΩ mA: 15Ω + 1.5V / V: 1.1MΩ
Max Over Current	35mA
Galvanic Isolation	None
Conversion Speed	Minimum All Channels Converted in app. < 250ms or 41ms per channel enable

Sensor Range and Accuracy	Input Type:	Range:	Accuracy:
	TC J (Ungrounded)	-120 to 1000°C / -184 to 1832°F	± 0.2% of full scale ± 1°C
	TC K (Ungrounded)	-130 to 1372°C / -202 to 2501.6°F	± 0.2% of full scale ± 1°C
	TC T (Ungrounded)	-130 to 400°C / -202 to 752°F	± 0.2% of full scale ± 1°C
	TC E (Ungrounded)	-130 to 780°C / -202 to 1436°F	± 0.2% of full scale ± 1°C
	TC N (Ungrounded)	-130 to 1300°C / -202 to 2372°F	± 0.2% of full scale ± 1°C
	TC R, S (Ungrounded)	20 to 1768°C / 68 to 3214.4°F	± 0.2% of full scale ± 3°C
	TC B (Ungrounded)	500 to 1820°C / 212 to 3308°F Functions below 500°C with reduced accuracy.	± 0.2% of full scale ± 3°C
	PT100/1000	-200 to 850°C / -328 to 1562°F	± 0.15% of full scale
	0-20mA	0-20mA	± 0.15% of full scale
	0-60mV	0-60mV	± 0.15% of full scale
	0-10V	0-10V	± 0.15% of full scale

The filter on the Model 6 board is based on the following equation:

$$Y = Y_{n-1} + ((Y_{n-1} - X_n) / FV)$$

Where Y is the new filter output Value, Y_{n-1} is the previous value, X is the new value just sampled and FV is the filter value. From the equation it can be seen that the larger the filter value (range 0-20) is, the smaller the portion of the new value is added to the previous value and the longer it takes to converge on the final value. A filter Value of 0 means no filter and the full new sample is used. Valid filter values are 0-20.

Analog Outputs

Number of Channels	4
Output Ranges	0-10VDC, 0-20mA, 4-20mA
Nominal Resolution	12 Bits
Maximum Error at 25°C (Excluding Zero)	0-20mA: 0.1% of full scale 0-10V: 0.1 % of full scale
Maximum Loop Voltage	27V
Response Time	One Update per program logic scan
Minimum Resistance Load	Canvas Models 0, 2-5: 500Ω Canvas Model 6: 400Ω
Conversion Speed	Minimum All Channels Once per Scan
Galvanic Isolation	None
Temperature Drift Error	20mA: 0.000143%/°C 0 - 10V: 0.000151%/°C

WIRING: INPUTS AND OUTPUTS

Analog Inputs Information

Raw input values for channels 1-4 are found in the registers as Integer-type data with a range from 0 – 32000. Analog inputs may be filtered digitally with the Filter Constant found in the Cscape Hardware Configuration for Analog Inputs. Valid filter values are 0-20.

Data Values	
Input Mode:	Data Format, 12-bit INT
0-20mA, 4-20mA	0-32000
0-10V	0-32000
T/C & RTD	Temperature units are selected in the Cscape Hardware Configuration between °C and °F. Temperature = Raw Value / 20

Digital Inputs Information

Positive Logic vs. Negative Logic

The OCS can be wired for positive logic inputs or negative.

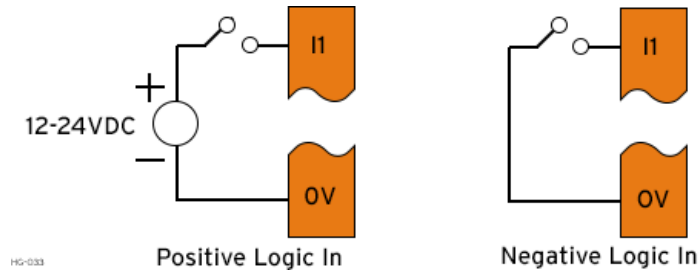

Digital inputs may be wired in either a Positive Logic or Negative Logic fashion as shown. The setting in the Cscape Hardware Configuration for the Digital Inputs must match the wiring used in order for the correct input states to be registered. When used as a normal input and not for high speed functions, the state of the input is reflected in registers %I1 – %I12. Digital inputs may alternately be specified for use with High Speed Counter functions, also found in the Hardware Configuration for Digital Inputs. Refer to the User Manual via the [Documentation Search](#) for more details.

Connector Overview

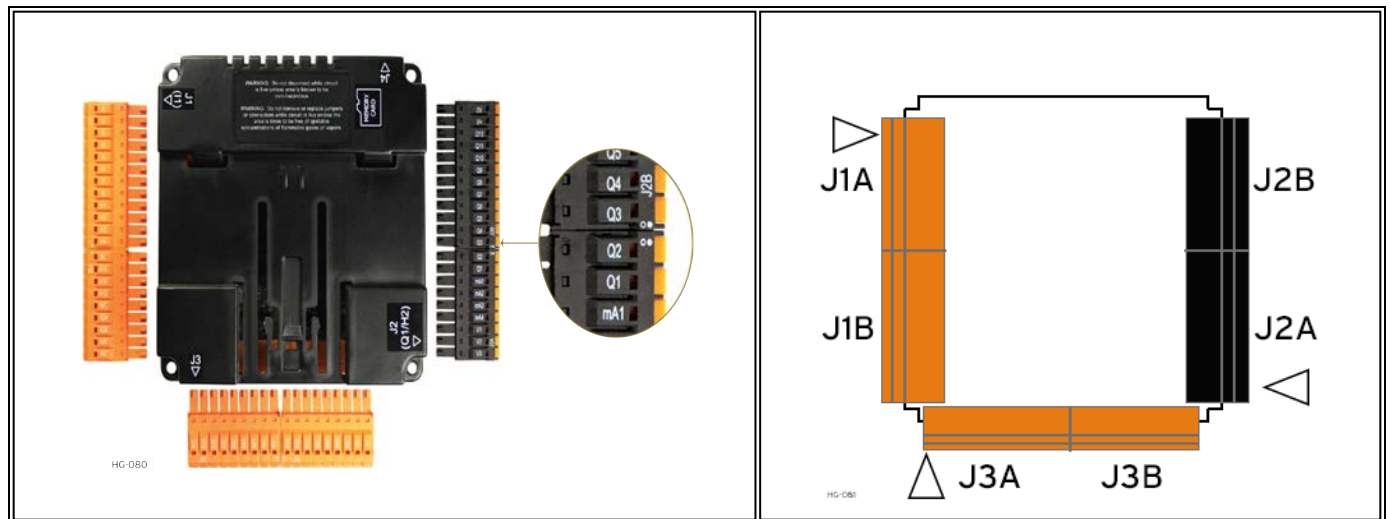

For ease of operability, the high density terminals are divided into more manageable pairs of connectors (J1A + J1B, J2A + J2B, J3A + J3B). To ensure proper installation, connector symbols must match.

J1 and J2 Wiring

J1 (Orange/Green) Name		
J1A	I1 (%I1)	Digital In 1
	I2 (%I2)	Digital In 2
	I3 (%I3)	Digital In 3
	I4 (%I4)	Digital In 4
	I5 (%I5)	Digital In 5
	I6 (%I6)	Digital In 6
	I7 (%I7)	Digital In 7
	I8 (%I8)	Digital In 8
	H1 (%I9)	HSC1/ Digital In 9
	H2 (%I10)	HSC2/ Digital In 10
	H3 (%I11)	HSC3/ Digital In 11
	H4 (%I12)	HSC4/ Digital In 12
J1B	0V	Common
	A1A (%AI33)	Universal AI 1 Pin 1
	A1B (%AI33)	Universal AI 1 Pin 2
	A1C (%AI33)	Universal AI 1 Pin 3
	NC	No Connect
	A2A (%AI34)	Universal AI 2 Pin 1
	A2B (%AI34)	Universal AI 2 Pin 2
	A2C (%AI34)	Universal AI 2 Pin 3
	NC	No Connect

12-24VDC

20mA Transmitter

T/C

HG-086

J2 Wiring

J2 (Black/Green) Name		
J2A	V3 (%AQ11)	V Out 3*
	V2 (%AQ10)	V Out 2*
	V1 (%AQ9)	V Out 1*
	mA4 (%Q4)	mA Out 4*
	mA3 (%Q3)	mA Out 3*
	mA2 (%Q2)	mA Out 2*
	mA1 (%Q1)	mA Out 1*
	Q1 (%Q1)	Digital Out 1/PWM1
	Q2 (%Q2)	Digital Out 2/PWM2
J2B	Q3 (%Q3)	Digital Out 3
	Q4 (%Q4)	Digital Out 4
	Q5 (%Q5)	Digital Out 5
	Q6 (%Q6)	Digital Out 6
	Q7 (%Q7)	Digital Out 7
	Q8 (%Q8)	Digital Out 8
	Q9 (%Q9)	Digital Out 9
	Q10 (%Q10)	Digital Out 10
	Q11 (%Q11)	Digital Out 11
	Q12 (%Q12)	Digital Out 12
	V+	V External+ (power for digital outputs)
	0V	Common

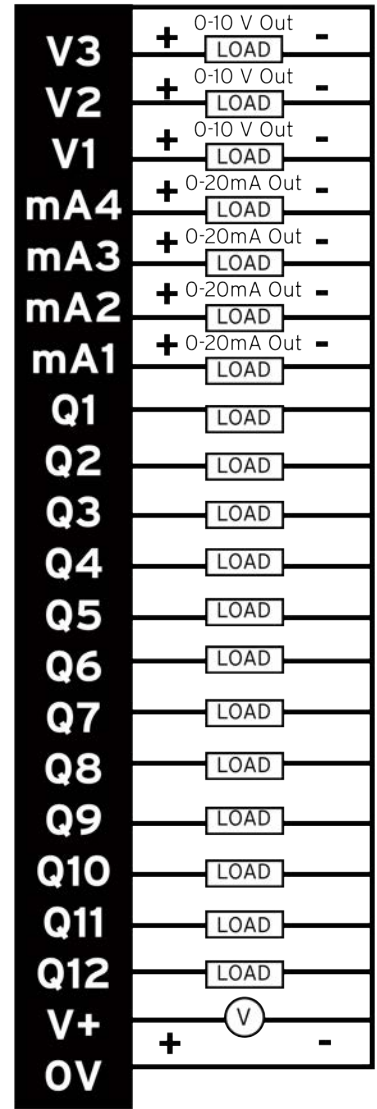

HG-085

J3 Wiring

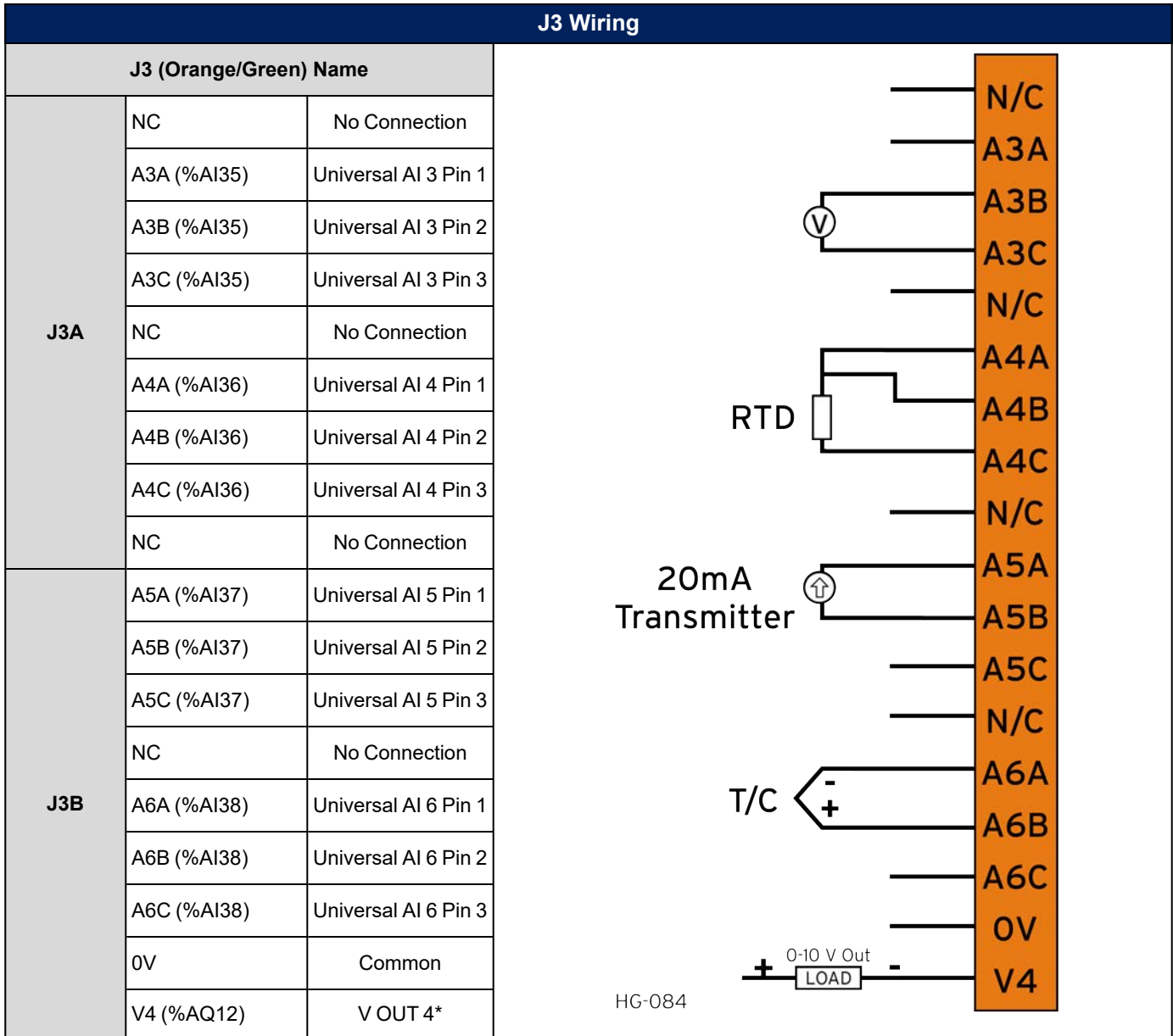

NOTE: * Both mA & V outputs are active for each output channel, however, only the configured output type is calibrated (maximum 4 channels simultaneously).

J3 Universal Wiring & Wiring Details

Solid/Standed Wire: 12-24 AWG (2.5-0.2mm²)

Strip Length: 0.28" (7mm)

Torque, Terminal Hold-Down Screws: 4.5 - 7 in•lbs (0.50 - 0.78 N•m)

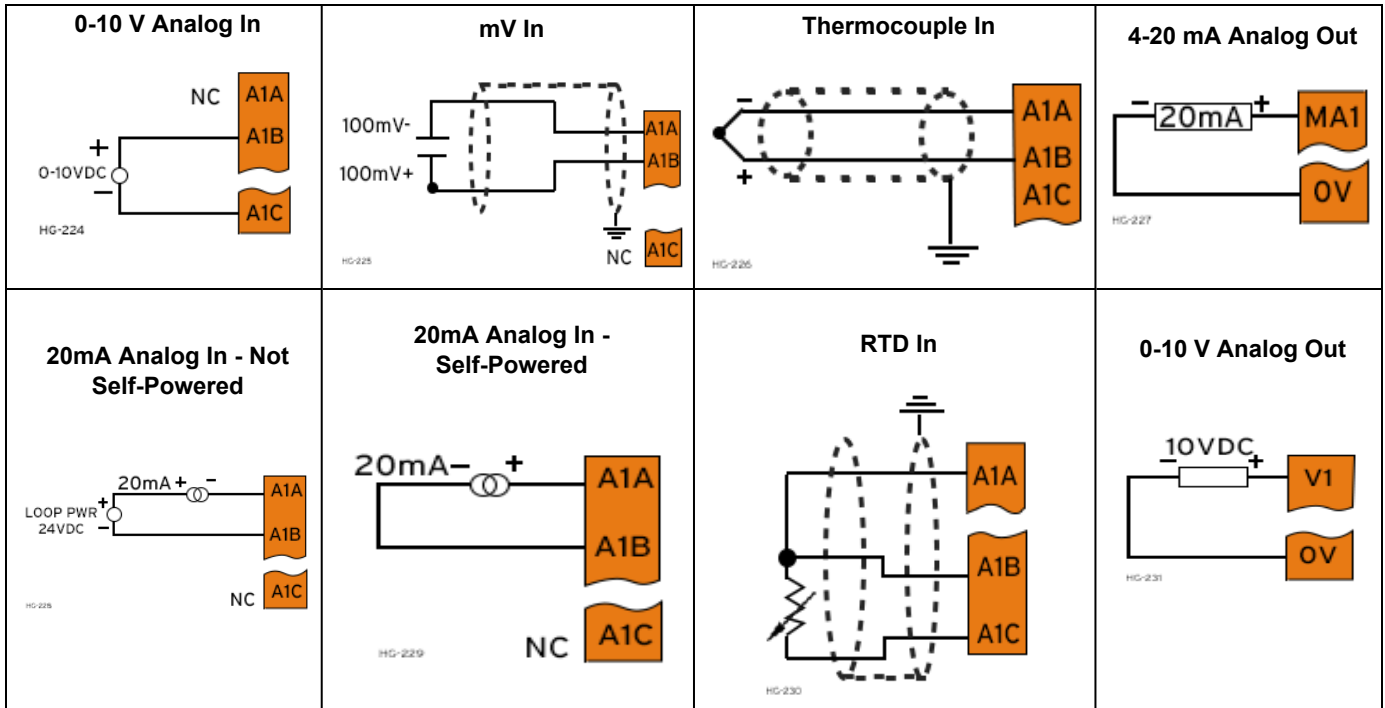

Status Registers

Selectable Register	Description							
%Rx*	Bit-wise status register enable: Set %Rx.1 - %Rx.9 high to enable for registers %R(x+1) to %R(x+9).							
%R(x+1)	Firmware version							
%R(x+2)	Watchdog count - cleared on power-up.							
%R(x+3)	Status Bits:				16...4	3	2	1
					Reserved	Normal	Config	Calibration
%R(x+4)	Scan rate of the 106 board (average) in units of 100 μ s.							
%R(x+5)	Scan rate of the 106 board (max) in units of 100 μ s.							
%R(x+6)	Channel Status: Channel 2				Channel 1			
	8	7	6	5	4	3	2	1
	Open RTD	Out of Limits	Shorted RTD	Open Sensor	Open RTD	Out of Limits	Shorted RTD	Open Sensor
%R(x+7)	Channel Status: Channel 4				Channel 3			
	8	7	6	5	4	3	2	1
	Open RTD	Out of Limits	Shorted RTD	Open Sensor	Open RTD	Out of Limits	Shorted RTD	Open Sensor
%R(x+8)	Channel Status: Channel 6				Channel 5			
	8	7	6	5	4	3	2	1
	Open RTD	Out of Limits	Shorted RTD	Open Sensor	Open RTD	Out of Limits	Shorted RTD	Open Sensor
%R(x+9...14)	Reserved							

*Example: %Rx= %R500, %R(x+1) = %R501, %R(x+2) = %R502, ...

Registers

The I/O is mapped into OCS Register space, in three separate areas: Digital/Analog I/O, High-Speed Counter I/O, and High-Speed Output I/O. Digital/Analog I/O location is fixed starting at 1, but the high-speed counter and high-speed output references may be mapped to any open register location.

Digital and Analog I/O Functions Registers	
Digital Inputs	%I1-12
Reserved	%I13-31
ESCP Alarm	%I32
Digital Outputs	%Q1-12
Reserved	%Q13-24
Analog Inputs	%AI33-38
Reserved	%AI1-32
Analog Outputs	%AQ9-12
Reserved	%AQ1-8

COMMUNICATIONS

Serial Communication

MJ1/2 Serial Ports

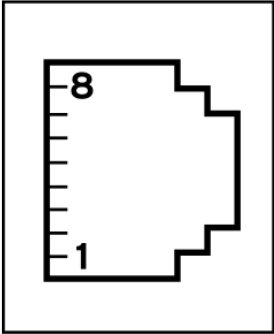
 <p>HG-008</p>	<p>MJ1: RS-232 w/Full Handshaking MJ2: RS-485 Half-Duplex</p>	MJ1 Pins			MJ2 Pins	
		PIN	SIGNAL	DIRECTION	SIGNAL	DIRECTION
		8	TXD	OUT	--	--
		7	RXD	IN	--	--
		6	0V	COMMON	0V	COMMON
		5	+5V @ 60mA	OUT	+5V @ 60mA	OUT
		4	RTS	OUT	--	--
		3	CTS	IN	--	--
		2	--	--	RX-/TX-	IN/OUT
		1	--	--	RX+/TX+	IN/OUT

MJ3 Serial Port

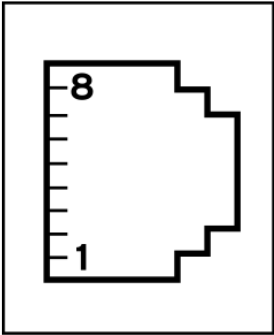
 <p>HG-008</p>	<p>2 Multiplexed Serial Ports on One Modular Jack (8 position)</p>	MJ3 PINS		
		PIN	SIGNAL	DIRECTION
		8	TXD RS-232	OUT
		7	RXD RS-232	IN
		6	0V	COMMON
		5	+5V @ 60mA	OUT
		4	TX- RS-485	OUT
		3	TX+ RS-485	OUT
		2	RX- RS-485	IN
		1	RX+ RS-485	IN

NOTE: Attach optional [ferrite core](#) with a minimum of two turns of serial cable.

Ethernet

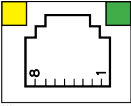
	<p>Green LED indicates link - when illuminated, data communication is available. Yellow LED indicates activity - when flashing, data is in transmission.</p>
---	---

DIP Switches

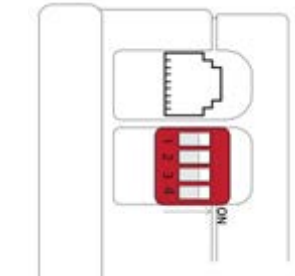
 <p>HG-552</p>	DIP Switches			
	SWITCH	NAME	FUNCTION	DEFAULT
	1	MJ3 RS-485 Termination	ON = Terminated	OFF
	2	MJ3 Duplex	Both ON = Half	OFF
	3		Both OFF = Full	OFF

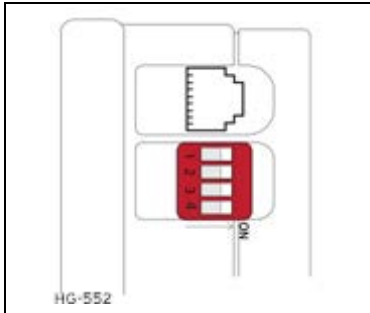
	DIP Switches		
	4	MJ2 RS-485 Termination	ON = Terminated OFF

The DIP switches are used to provide a built-in termination to both the MJ1, MJ2 & MJ3 ports if needed. The termination for these ports should only be used if this device is located at either end of the multidrop/ daisy-chained RS-485 network.

CAN Communications

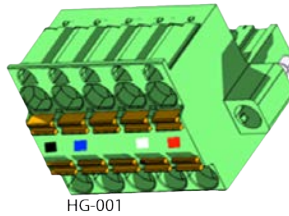

CAN Network & Power Port Pin Assignment		
Pin	Signal	Signal Description
1	V-	CAN Ground – Black
2	CN_L	CAN Data Low – Blue
3	SHLD	Shield Ground – None
4	CN_H	CAN Data High – White
5	V+ (NC)	No Connect – Red

- **Solid/Stranded Wire:** 12-24 AWG (2.5-0.2mm²).
- **Strip Length:** 0.28" (7mm).
- Locking spring-clamp, two-terminators per conductor.
- **Torque, Terminal Hold-Down Screws:** 4.5 – 7 in•lbs (0.50 – 0.78 N•m).
- V+ pin is not internally connected, the SHLD pin is connected to Earth ground via a 1MΩ resistor and 10 nF capacitor.

DIMENSIONS & INSTALLATION

Dimensions & Panel Cutout

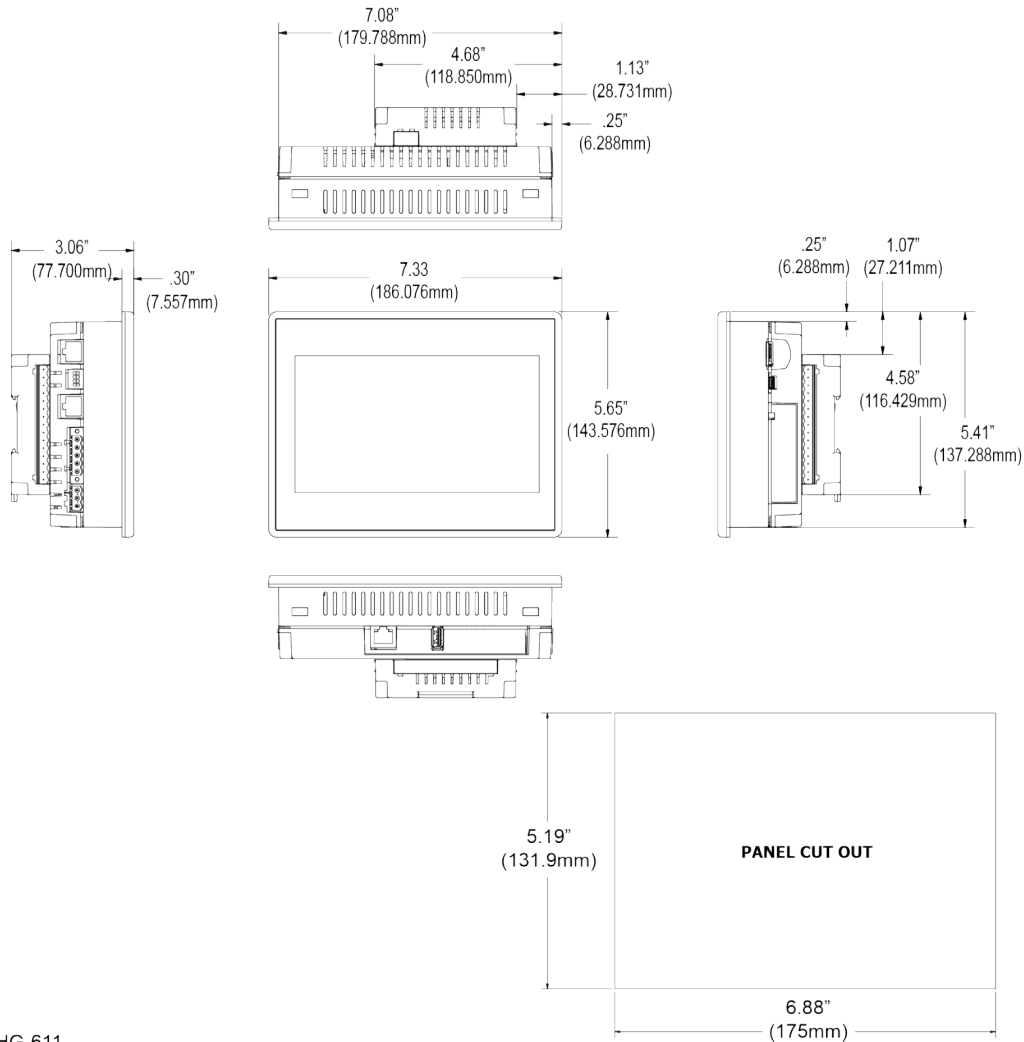

HG-611

+1.0 mm / -0 mm cutout tolerance

Installation Information

- The Canvas 7 utilizes a clip installation method to ensure a robust and watertight seal to the enclosure. Use the following steps for correct installation and operation of the unit.
- This equipment is suitable for Class I, Division 2, Groups A, B, C and D or non-hazardous locations only.
- Digital outputs shall be supplied from the same source as the operator control station.
- Jumpers on connector JP1 shall not be removed or replaced while the circuit is live unless the area is known to be free of ignitable concentrations of flammable gases or vapors.

Installation Procedure

1. Carefully locate an appropriate place to mount the Canvas 7. Be sure to leave enough room at the top of the unit for insertion and removal of the microSD™ card.
2. Carefully cut the host panel per the diagram, creating a 131.9mm x 175.0mm, with a +1.0 mm / -0 mm panel cutout tolerance, opening into which the Canvas 7 may be installed. If the opening is too large, water may leak into the enclosure, potentially damaging the unit. If the opening is too small, the OCS may not fit through the hole without damage.
3. Remove any burrs and or sharp edges and ensure the panel is not warped in the cutting process.
4. Remove all Removable Terminals from the Canvas 7. Insert the Canvas 7 through the panel cutout (from the front). The gasket must be between the host panel and the OCS.
5. Install and tighten the four mounting clips (provided in the box) until the gasket forms a tight seal. **NOTE:** Maximum torque is 0.8 to 1.13N•m, or 7 to 10 in•lbs.
6. Reinstall the Canvas 7 I/O Removable Terminal Blocks. Connect communications cables to the serial port, USB ports, Ethernet port, and CAN port as required.

SAFETY & MAINTENANCE

Warnings

1. To avoid the risk of electric shock or burns, always connect the safety (or earth) ground before making any other connections.
2. To reduce the risk of fire, electrical shock, or physical injury, it is strongly recommended to fuse the voltage measurement inputs. Be sure to locate fuses as close to the source as possible.
3. Replace fuse with the same type and rating to provide protection against risk of fire and shock hazards.
4. In the event of repeated failure, do **NOT** replace the fuse again as repeated failure indicates a defective condition that will **NOT** clear by replacing the fuse.
5. Only qualified electrical personnel familiar with the construction and operation of this equipment and the hazards involved should install, adjust, operate, or service this equipment.
6. Read and understand this manual and other applicable manuals in their entirety before proceeding. Failure to observe this precaution could result in severe bodily injury or loss of life.
7. **WARNING:** Battery may explode if mistreated. Do not recharge, disassemble, or dispose of in fire.
8. **WARNING:** EXPLOSION HAZARD- Batteries must only be changed in an area known to be non-hazardous.
9. **WARNING:** Do not disconnect while circuit is live unless area is know to be non-hazardous.

FCC Compliance

This device complies with Part 15 of the FCC Rules. Operation is subject to the following two conditions:

1. This device may not cause harmful interference.
2. This device must accept any interference received, including interference that may cause undesired operation.

Precautions

All applicable codes and standards need to be followed in the installation of this product. Adhere to the following safety precautions whenever any type of connection is made to the module:

1. Connect the safety (earth) ground on the power connector first before making any other connections.
2. When connecting to the electric circuits or pulse-initiating equipment, open their related breakers.
3. Do NOT make connection to live power lines.
4. Make connections to the module first; then connect to the circuit to be monitored.
5. Route power wires in a safe manner in accordance with good practice and local codes.
6. Wear proper personal protective equipment including safety glasses and insulated gloves when making connections to power circuits.
7. Ensure hands, shoes, and floor are dry before making any connection to a power line.
8. Make sure the unit is turned OFF before making connections to terminals.
9. Make sure all circuits are de-energized before making connections.
10. Before each use, inspect all cables for breaks or cracks in the insulation. Replace immediately if defective.
11. Use copper conductors in field wiring only, 60/75°C.



- 12. Use caution when connecting controllers to PCs via serial or USB. PCs, especially laptops, may use “floating power supplies” that are ungrounded. This could cause a damaging voltage potential between the laptop and controller. Ensure the controller and laptop are grounded for maximum protection. Consider using a USB isolator due to voltage potential differences as a preventative measure.

Technical Support

North America	Europe
1 (317) 916-4274 1 (877) 665-5666 www.hornerautomation.com APGUSATechSupport@heapg.com	+353 (21) 4321-266 www.hornerautomation.eu technical.support@horner-apg.com