

CANVAS 7D QUICK REFERENCE GUIDE

GENERAL SPECIFICATIONS

Required Power (Inrush)	25A for < 1ms @ 24VDC, DC switched
Primary Power Range	10 - 30VDC
Relative Humidity	5 to 95% non-condensing
Clock Accuracy	±20 ppm maximum at 25°C (± min/month)
Real Time Clock	Battery Backed, Lithium Coin
Operating Air Temp	-10°C to +60°C
Storage Temp	-20°C to +60°C
Weight (without I/O)	2 lbs (907g)
Altitude	Up to 2000m
Rated Pollution Degree	Pollution Degree 2 Rating
Certifications (UL/CE)	North America: https://hornerautomation.com/certifications/ Europe: http://www.horner-apg.com/en/support/certification.aspx

1. Touchscreen
2. Function Keys
3. MJ1: RS-232/ MJ2: 1/2 duplex RS-485
4. DIP Switches
5. MJ3: RS-232/485 Serial Port
6. CAN1 Port
7. Power: 10-30VDC In
8. Audio In & Out Ports
9. USB 2.0 A
10. LAN 1 & 2 Ports
11. CAN2 Port
12. USB mini "B": Programming
13. microSD: Data Storage

NOTE: See Precaution #16 about USB and grounding.

CONTROLLER OVERVIEW

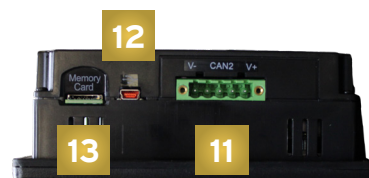
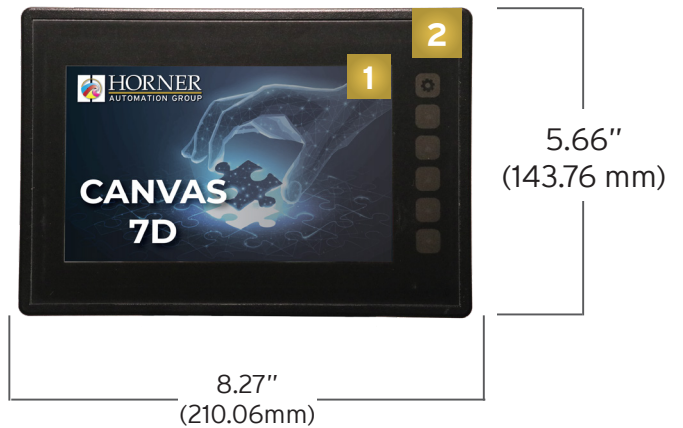
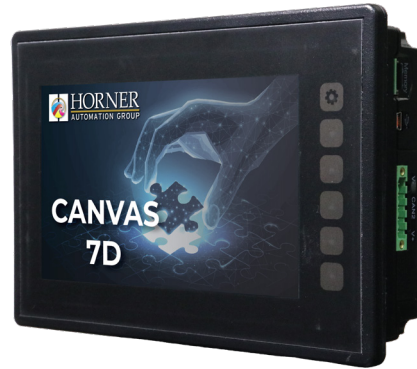

POWER WIRING

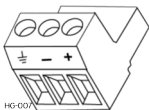

Primary Power Port Pins		
PIN	SIGNAL	DESCRIPTION
1	Ground	Frame Ground
2	DC-	Input Power Supply Ground
3	DC+	Input Power Supply Voltage

NOTE: Primary Power Range: 10-30VDC

WIRING

MODEL 2: 12 DC In, 6 Relay Out, (4) 12-bit Analog In

J1 (Orange) Name	
I1 (%I1)	Digital In 1
I2 (%I2)	Digital In 2
I3 (%I3)	Digital In 3
I4 (%I4)	Digital In 4
I5 (%I5)	Digital In 5
I6 (%I6)	Digital In 6
I7 (%I7)	Digital In 7
I8 (%I8)	Digital In 8
H1 (%I9)	HSC1/Dig. In 9
OV	Common
A1 (%AI1)	Analog In 1
A2 (%AI2)	Analog In 2
A3 (%AI3)	Analog In 3
A4 (%AI4)	Analog In 4
OV	Common

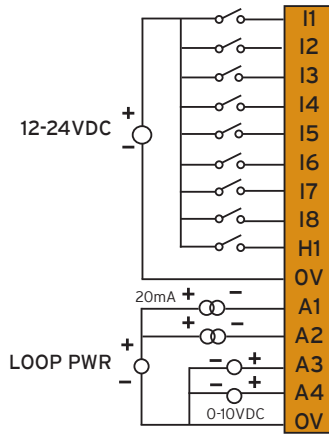

J2 (Black) Name	
C6 (%Q6)	Relay 6 COM
R6 (%Q6)	Relay 6 NO
C5 (%Q5)	Relay 5 COM
R5 (%Q5)	Relay 5 NO
C4 (%Q4)	Relay 4 COM
R4 (%Q4)	Relay 4 NO
C3 (%Q3)	Relay 3 COM
R3 (%Q3)	Relay 3 NO
C2 (%Q2)	Relay 2 COM
R2 (%Q2)	Relay 2 NO
C1 (%Q1)	Relay 1 COM
R1 (%Q1)	Relay 1 NO
H4 (%QI12)	HSC4/Dig. In 12
H3 (%QI11)	HSC3/Dig. In 11
H2 (%QI10)	HSC2/Dig. In 10

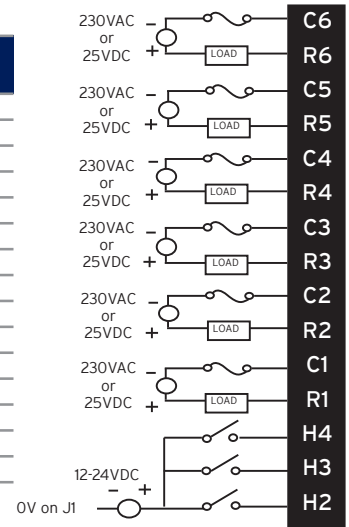

MODEL 3: 12 DC In, 12 DC Out, (2) 12-bit Analog In

J1 (Orange) Name	
I1 (%I1)	Digital In 1
I2 (%I2)	Digital In 2
I3 (%I3)	Digital In 3
I4 (%I4)	Digital In 4
I5 (%I5)	Digital In 5
I6 (%I6)	Digital In 6
I7 (%I7)	Digital In 7
I8 (%I8)	Digital In 8
H1 (%I9)	HSC1/Dig. In 9
H2 (%I10)	HSC1/Dig. In 10
H3 (%I11)	HSC1/Dig. In 11
H4 (%I12)	HSC1/Dig. In 12
A1 (%AI1)	Analog In 1
A2 (%AI2)	Analog In 2
OV	Common

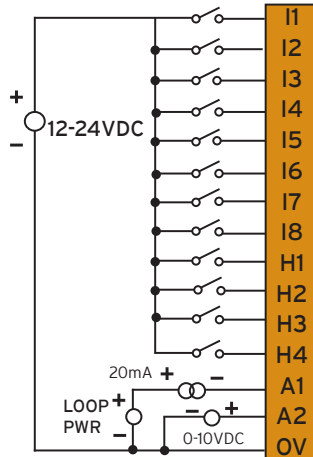

J2 (Black) Name	
OV	Common
V+	V+
NC	No Connect
Q12 (%Q12)	Digital Out 12
Q11 (%Q11)	Digital Out 11
Q10 (%Q10)	Digital Out 10
Q9 (%Q9)	Digital Out 9
Q8 (%Q8)	Digital Out 8
Q7 (%Q7)	Digital Out 7
Q6 (%Q6)	Digital Out 6
Q5 (%Q5)	Digital Out 5
Q4 (%Q4)	Digital Out 4
Q3 (%Q3)	Digital Out 3
Q2 (%Q2)	Dig. Out/PWM2
Q1 (%Q1)	Dig. Out/PWM1

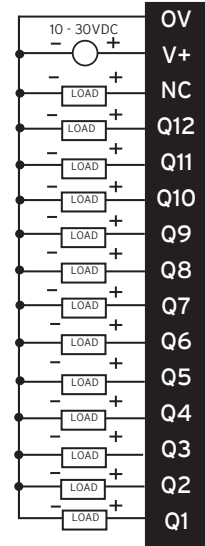

MODEL 4: 24 DC In, 16 DC Out, (2) 12-bit Analog In

J1 (Orange) Name	
I1 (%I1)	Digital In 1
I2 (%I2)	Digital In 2
I3 (%I3)	Digital In 3
I4 (%I4)	Digital In 4
I5 (%I5)	Digital In 5
I6 (%I6)	Digital In 6
I7 (%I7)	Digital In 7
I8 (%I8)	Digital In 8
H1 (%I9)	HSC1/Dig. In 9
H2 (%I10)	HSC1/Dig. In 10
H3 (%I11)	HSC1/Dig. In 11
H4 (%I12)	HSC1/Dig. In 12
A1 (%AI1)	Analog In 1
A2 (%AI2)	Analog In 2
OV	Common

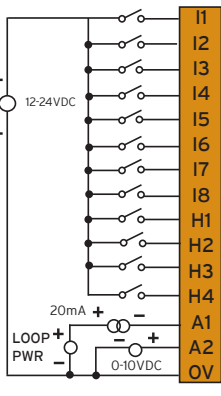

J2 (Black) Name	
OV	Common
V+	V+
Q13 (%Q13)	Digital Out 13
Q12 (%Q12)	Digital Out 12
Q11 (%Q11)	Digital Out 11
Q10 (%Q10)	Digital Out 10
Q9 (%Q9)	Digital Out 9
Q8 (%Q8)	Digital Out 8
Q7 (%Q7)	Digital Out 7
Q6 (%Q6)	Digital Out 6
Q5 (%Q5)	Digital Out 5
Q4 (%Q4)	Digital Out 4
Q3 (%Q3)	Digital Out 3
Q2 (%Q2)	Dig. Out/PWM2
Q1 (%Q1)	Dig. Out/PWM1

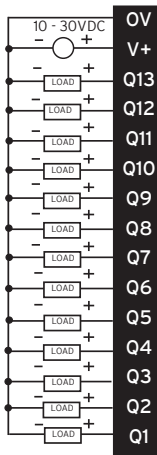

J3 (Orange) Name	
I13 (%I13)	Digital In 13
I14 (%I14)	Digital In 14
I15 (%I15)	Digital In 15
I16 (%I16)	Digital In 16
I17 (%I17)	Digital In 17
I18 (%I18)	Digital In 18
I19 (%I19)	Digital In 19
I20 (%I20)	Digital In 20
I21 (%I21)	Digital In 21
I22 (%I22)	Digital In 22
I23 (%I23)	Digital In 23
I24 (%I24)	Digital In 24
OV	Common

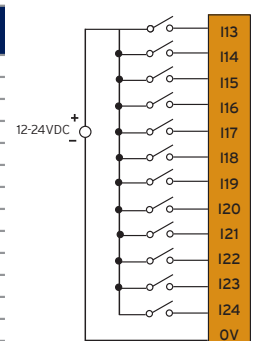

J4 (Orange) Name	
Q16 (%Q16)	Digital Out 16
Q15 (%Q15)	Digital Out 15
Q14 (%Q14)	Digital Out 14

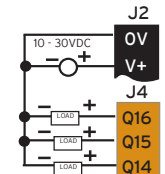

WIRING: I-O continued...

MODEL 5: 12 DC In, 12 DC Out, (2) 14/16-bit Analog In (mA/V/TC/mV/RTD), (2) 12-bit Analog Out

J1 (Orange) Name	
I1 (%I1)	Digital In 1
I2 (%I2)	Digital In 2
I3 (%I3)	Digital In 3
I4 (%I4)	Digital In 4
I5 (%I5)	Digital In 5
I6 (%I6)	Digital In 6
I7 (%I7)	Digital In 7
I8 (%I8)	Digital In 8
H1 (%I9)	HSC1/Dig. In 9
H2 (%I10)	HSC2/Dig. In 10
H3 (%I11)	HSC3/Dig. In 11
H4 (%I12)	HSC4/Dig. In 12
NC	No Connect
NC	No Connect
OV	Common

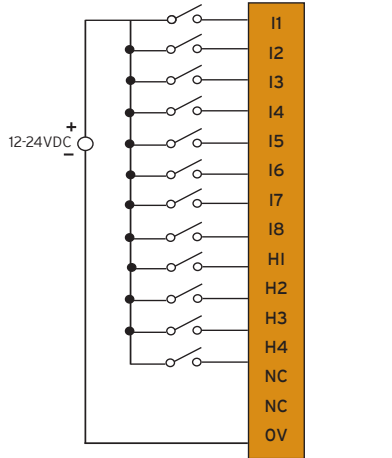

J2 (Black) Name	
OV	Common
V+*	Output Power
NC	No Connect
Q12 (%Q12)	Digital Out 12
Q11 (%Q11)	Digital Out 11
Q10 (%Q10)	Digital Out 10
Q9 (%Q9)	Digital Out 9
Q8 (%Q8)	Digital Out 8
Q7 (%Q7)	Digital Out 7
Q6 (%Q6)	Digital Out 6
Q5 (%Q5)	Digital Out 5
Q4 (%Q4)	Digital Out 4
Q3 (%Q3)	Digital Out 3
Q2 (%Q2)	Dig. Out/PWM2
Q1 (%Q1)	Dig. Out/PWM1

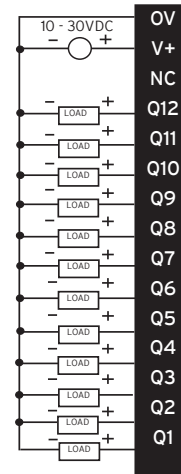

J3 (Orange) Name	
T1+ (%AI1)	TC (1+) or RTD (1+) or 100 mV (1+)
T1- (%AI1)	TC (1-) or RTD (1-) or 100 mV (1-)
T2+ (%AI2)	TC (2+) or RTD (2+) or 100 mV (2+)
T2- (%AI2)	TC (2-) or RTD (2-) or 100 mV (2-)
AQ1 (%AQ9)	10V or 20mA OUT (1)
AQ2 (%AQ10)	10V or 20mA OUT (2)
OV	Common
MA1 (%AI1)	0-20mA IN (1)
V1 (%AI1)	0-10V IN (1)
OV	Common
MA2 (%AI2)	0-20mA IN (2)
V2 (%AI2)	0-10V IN (2)
OV	Common

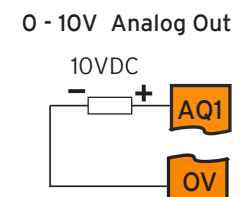
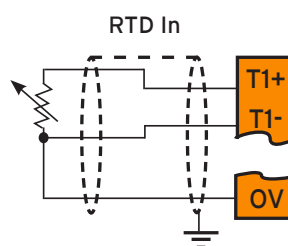
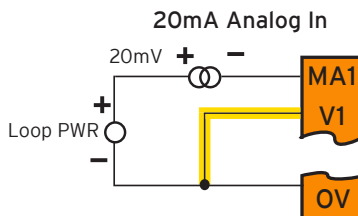
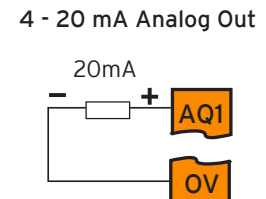
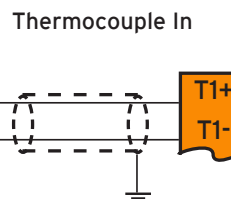
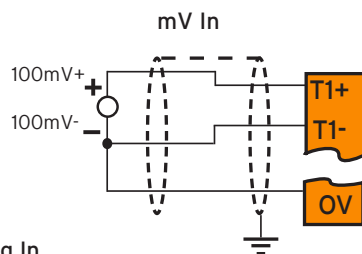
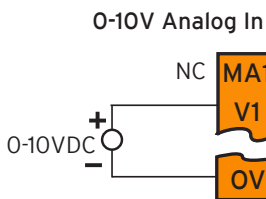
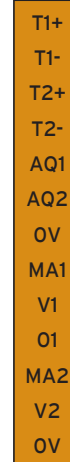

NOTE: Loop power requirements are determined by the transmitter specification.

NOTE: Be sure to wire OV to V1 as shown for proper operation.

WIRING: I-O continued...

MODEL 6: 12 DC In, 12 DC Out, 6-14/17-bit Analog In (mA/V/TC/mV/RTD), 4-12-bit Analog Out

J1 (Orange/Green) Name		
J1A	I1 (%I1)	Digital In 1
	I2 (%I2)	Digital In 12
	I3 (%I3)	Digital In 13
	I4 (%I4)	Digital In 14
	I5 (%I5)	Digital In 15
	I6 (%I6)	Digital In 16
	I7 (%I7)	Digital In 17
	I8 (%I8)	Digital In 18
	H1 (%I9)	HSC1/V Dig. In 9
	H2 (%I10)	HSC2/V Dig. In 10
	H3 (%I11)	HSC3/V Dig. In 11
	H4 (%I12)	HSC4/V Dig. In 12
J1B	OV	Common
	A1A (%AI33)	Univ. AI 1 Pin 1
	A1B (%AI33)	Univ. AI 1 Pin 2
	A1C (%AI33)	Univ. AI 1 Pin 3
	NC	No Connect
	A2A (%AI34)	Univ. AI 2 Pin 1
	A2B (%AI34)	Univ. AI 2 Pin 2
	A2C (%AI34)	Univ. AI 2 Pin 3
	NC	No Connect

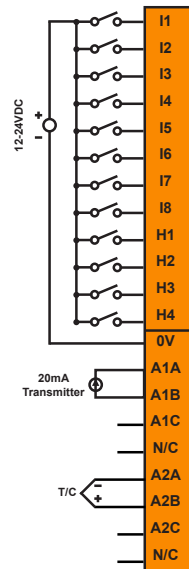

J3 (Orange/Green) Name		
Univ. AI	NC	No Connection
	A3A (%AI35)	Univ. AI 3 Pin 1
	A3B (%AI35)	Univ. AI 3 Pin 2
	A3C (%AI35)	Univ. AI 3 Pin 3
	NC	No Connection
	A4A (%AI36)	Univ. AI 4 Pin 1
	A4B (%AI36)	Univ. AI 4 Pin 2
	A4C (%AI36)	Univ. AI 4 Pin 3
	NC	No Connection
	A5A (%AI37)	Univ. AI 5 Pin 1
	A5B (%AI37)	Univ. AI 5 Pin 2
	A5C (%AI37)	Univ. AI 5 Pin 3
Univ. AI	NC	No Connection
	A6A (%AI38)	Univ. AI 6 Pin 1
	A6B (%AI38)	Univ. AI 6 Pin 2
	A6C (%AI38)	Univ. AI 6 Pin 3
	OV	Common
	V4 (%AQ12)	V OUT 4*

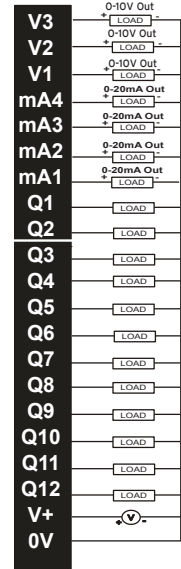

J2 (Black/Green) Name		
J2A	V3 (%AQ11)	V Out 3*
	V2 (%AQ10)	V Out 2*
	V1 (%AQ9)	V Out 1*
	mA4 (%Q4)	mA Out 4*
	mA3 (%Q3)	mA Out 3*
	mA2 (%Q2)	mA Out 2*
	mA1 (%Q1)	mA Out 1*
	Q1 (%Q1)	Dig. Out 1/PWM1
	Q2 (%Q2)	Dig. Out 1/PWM2
	Q3 (%Q3)	Digital Out 3
	Q4 (%Q4)	Digital Out 4
	Q5 (%Q5)	Digital Out 5
J2B	Q6 (%Q6)	Digital Out 6
	Q7 (%Q7)	Digital Out 7
	Q8 (%Q8)	Digital Out 8
	Q9 (%Q9)	Digital Out 9
	Q10 (%Q10)	Digital Out 10
	Q11 (%Q11)	Digital Out 11
	Q12 (%Q12)	Digital Out 12
	V+	V External+
OV	Common	

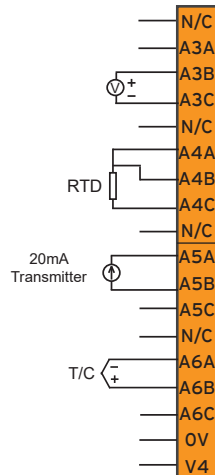

NOTE: * Both mA & V outputs are active for each output channel, however, only the configured output type is calibrated (maximum 4 channels simultaneously).

DIMENSIONS & INSTALLATION

Panel Cutout

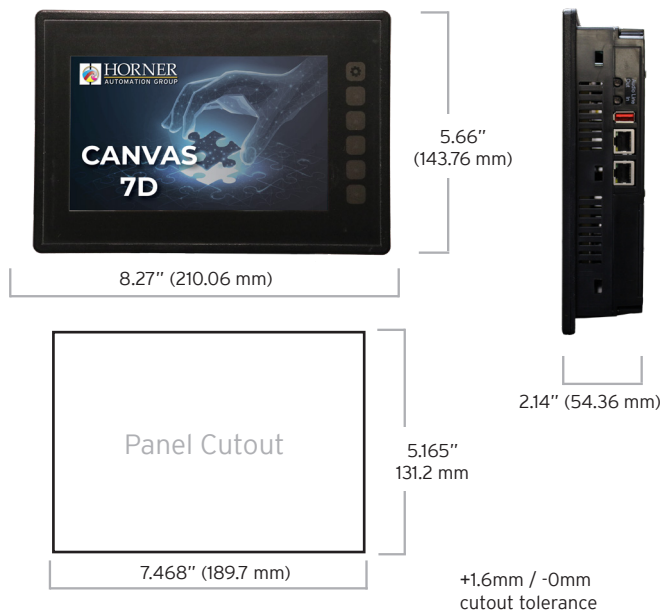

Installation Procedure

This equipment is panel mounted and is meant to be installed in an enclosure suitable for the environment, such that the back of the equipment is only accessible with the use of a tool.

This equipment is suitable for use in Class I, Division 2, Groups A, B, C and D; Class II, Division 2 Groups F and G; and Class III Hazardous Locations or Non-Hazardous Locations only.

The Canvas 7D utilizes a clip installation method to ensure a robust and watertight seal to the enclosure. Please follow the steps below for the proper installation and operation of the unit.

1. Carefully locate an appropriate place to mount the Canvas 7D. Be sure to leave enough room at the top of the unit for insertion and removal of the microSD™ card.
2. Carefully cut the host panel per the diagram, creating a 189.7mm x131.2 mm (with a tolerance of +1.6mm/ -0mm) opening into which the Canvas 7D is to be installed. If the opening is too large, water may leak into the enclosure, potentially damaging the unit. If the opening is too small, the OCS may not fit through the hole without damage.
3. Remove any burrs/sharp edges and ensure the panel is not warped in the cutting process.
4. Install and tighten the four mounting clips (provided in the box) until the gasket forms a tight seal. For included metal mounting clips, use a torque rating of 7-10 in-lbs (0.79-1.13 N·m).
5. Connect communications cables to the serial port, USB ports, and CAN port as required.

SAFETY

All applicable codes and standards need to be followed in the installation of this product. Adhere to the following safety precautions whenever any type of connection is made to the module:

1. Connect the safety (earth) ground on the power connector first before making any other connections.
2. When connecting to the electric circuits or pulse-initiating equipment, open their related breakers.

3. Do NOT make connection to live power lines.
4. Make connections to the module first; then connect to the circuit to be monitored.
5. Route power wires in a safe manner in accordance with good practice and local codes.
6. Wear proper personal protective equipment including safety glasses and insulated gloves when making connections to power circuits.
7. Ensure hands, shoes, and floor are dry before making any connection to a power line.
8. Make sure the unit is turned OFF before making connection to terminals.
9. Make sure all circuits are de-energized before making connections.
10. Before each use, inspect all cables for breaks or cracks in the insulation. Replace immediately if defective.
11. Use copper conductors in Field Wiring only, 60/75°C.
12. Do not disconnect while circuit is live unless area is known to be non-hazardous.
13. Do not remove or replace jumpers or connectors while circuit is live unless the area is known to be free of ignitable concentrations of flammable gases or vapors.
14. Use caution when making connections to the controller to protect against static discharge. Special care must be taken when replacing the battery or inserting or adjusting I/O or communication boards.
15. Use caution when connecting controllers to PCs via serial or USB. PCs, especially laptops may use "floating power supplies" that are ungrounded. This could cause a damaging voltage potential between the laptop and controller. Ensure the controller and laptop are grounded for maximum protection. Consider using a USB isolator due to voltage potential differences as a preventative measure.
16. Failure to follow these guidelines can damage the controller and/or other devices.

Hazardous Location Notice

Power, input and output (I/O) wiring must be in accordance with Class 1, Division 2 wiring methods [Article 501-4(b) of the National Electrical Code, NFPA 70] for installations in the U.S. or as specified in Section 18-1J2 of the Canadian Electrical Code for installations within Canada and in accordance with the authority having jurisdiction.

1. THIS EQUIPMENT IS SUITABLE FOR USE IN CLASS I, DIVISION 2, GROUPS A B C D OR NON-HAZARDOUS LOCATIONS ONLY.
2. WARNING - EXPLOSION HAZARD - SUBSTITUTION OF COMPONENTS MAY IMPAIR SUITABILITY FOR CLASS I, DIVISION 2.
AVERTISSEMENT - RISQUE D'EXPLOSION LA SUBSTITUTION DE COMPOSANTS PEUT RENDRE CATE MATE RIEL INACCEPTABLE POUR LES EMPLACEMENTS DE CLASSE I, DIVISION 2
3. WARNING - EXPLOSION HAZARD - DO NOT DISCONNECT EQUIPMENT UNLESS POWER HAS BEEN SWITCHED OFF OR THE AREA IS KNOWN TO BE NON-HAZARDOUS AND FREE OF IGNITABLE CONCENTRATIONS.
ATTENTION - RISQUE D'EXPLOSION - NE DECONNECTEZ PAS L'EQUIPEMENT A MOINS DE L'AVOIR MIS HORS TENSION OU QUE LA ZONE EST CONNUE NON-DANGEREUSE ET NE CONTIENT PAS DE CONCENTRATIONS INFLAMMABLES.
4. WARNING - EXPLOSION HAZARD - BATTERIES MUST ONLY BE CHARGED IN AN AREA KNOWN TO BE NON-HAZARDOUS.
AVERTISSEMENT - RISQUE D'EXPLOSION - LES PILES NE DOIVENT ÊTRE CHARGÉES QUE DANS UN ENDROIT DE DANGER NON DANGEREUX.
5. WARNING - Battery may explode if mistreated. Do not recharge, disassemble, or dispose of in fire.
AVERTISSEMENT - La batterie peut exploser si elle est maltraitée. Ne pas recharger, démonter ou jeter au feu.

FCC Compliance

This device complies with part 15 of the FCC Rules. Operation is subject to the following two conditions:

1. This device may not cause harmful interference
2. This device must accept any interference received, including interference that may cause undesired operation

TECHNICAL SUPPORT

For further details, please refer to the Datasheets, MAN1112 - MAN1117. For assistance and manual updates, contact Technical Support at the following locations:

North America
+1 (317) 916-4274
www.hornerautomation.com
techsppt@heapg.com

Europe
+353 (21) 4321-266
www.hornerautomation.eu
technical.support@horner-apg.com