

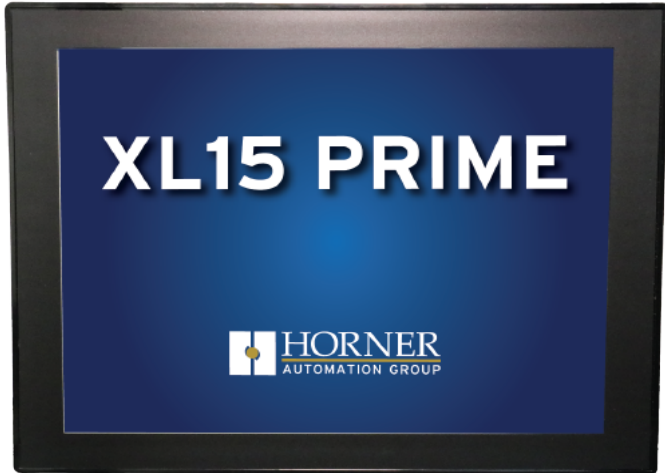

# XL15 Prime OCS Datasheet - Model 0

No Built-In I/O

MAN1479\_00\_EN\_XL15P\_Mod0



HG-668

**Part Number: HE-XP15E0**

## User Manual and Add-Ons

Find the documents with the [Documentation Search](#).

Part #	Description
MAN1485	User Manual for XL15 Prime OCS
HE-BAT013	Packaged lithium coin cell battery
HE-XCK	Programming Cable Kit
HE-PRGA2C	USB-A to USB-C programming cable.
HE-PRGC2C	USB-C to USB-C programming cable.
HE-XDAC007	2 channel Analog Output I/O option kit, selectable 0-10V, $\pm 10V$ , 4-20mA.
HE-XDAC107	4 channel Analog Output I/O option kit, selectable 0-10V, $\pm 10V$ , 4-20mA.
HE-XKIT	Blank I/O Board
HE200MJ2TRM	Adapter, RJ45 (8P8C) male to 8-position terminal strip.
HE-FBD001	Ferrite core for filtering out electrical noise.

## Battery Maintenance

The XL15 Prime uses a packaged lithium coin cell battery to run the Real Time Clock. The battery life is 7-10 years. For instruction on replacing the battery, see **MAN1485**.

## Table of Contents

Part Number: HE-XP15E0 .....	1
User Manual and Add-Ons .....	1
Battery Maintenance .....	1
<b>TECHNICAL SPECIFICATIONS .....</b>	<b>2</b>
General Specifications .....	2
Control and Logic .....	2
Display .....	2
Connectivity .....	3
USB Webcams .....	3
XL15 Prime User Manual [MAN1485] .....	3
<b>CONTROLLER OVERVIEW .....</b>	<b>4</b>
Port Controllers .....	4
Power Wiring .....	5
<b>COMMUNICATIONS .....</b>	<b>6</b>
Serial Communications .....	6
Ethernet .....	6
DIP Switches .....	7
CAN Communications .....	8
<b>DIMENSIONS &amp; INSTALLATION .....</b>	<b>9</b>
Installation Procedure .....	10
<b>SAFETY &amp; MAINTENANCE .....</b>	<b>11</b>
Warnings .....	11
FCC Compliance .....	11
Precautions .....	11

## TECHNICAL SPECIFICATIONS

### General Specifications

Required Power (Steady State)	1800mA @ 10V (18W) 700mA @ 24V (16.8W)
Inrush Current	25A for < 1ms @ 24VDC
USB Type C Required Input Power	1.0A @ 5V (5W) No display or I/O
Power Backlight 50%	260mA @ 24 VDC
Power Backlight Off	240mA @ 24 VDC
Primary Power Range	10–30VDC
Real Time Clock	With Battery (7-10 Years life, Replaceable)
Clock Accuracy	± 20 ppm maximum at 25°C (± 1 min/month)
Relative Humidity	5% to 95% non-condensing
Operating Temperature	-10°C to +60°C
Storage Temperature	-20°C to +70°C
Weight	6.97lbs/3.16kg (without I/O)
Certifications (UL/CE)	<a href="#">North America</a> or <a href="#">Europe</a>

### Control and Logic

Control Language Support	Advanced Ladder Logic Full IEC 1131-3 Languages
Logic Program Size & Scan Rate	2MB
Online Programming Changes	Supported in Advanced Ladder
Logic Scan Rate	0.02ms/kB
Digital Inputs	2048
Digital Outputs	2048
Analog Inputs	512
Analog Outputs	512
General Purpose Registers	49,999 (words) Retentive 16,384 (bits) Retentive 16,384 (bits) Non-retentive

### Display

Display Type	15" XGA TFT (500 cd/m <sup>2</sup> typical)
Resolution	1024 x 768
Color	24-bit (16,777,216)
Built-In Storage	8 GB
User-Program Screens	1023 max pages; 1023 objects per page
Backlight	LED - 50,000 hour life
Brightness Control	0-100% via System Register
Touchscreen	Resistive with laminated cover

## Connectivity

Serial Ports	1 RS-232 & 1 RS-485 on first Modular Jack (MJ1/2); 1 RS-232 or 1 RS-485 on second Modular Jack (MJ3)
USB C	USB 2.0 (480Mbps) Programming & Data Access
USB A (1000mA max)	USB 2.0 (HS) for USB flash drives ( $\leq 2$ TB)
CAN Ports (Independently Isolated)	2
CAN Protocols	CsCAN, CANopen, DeviceNet, J1939
Ethernet Ports	2 x 10/100 Mbps (Auto-MDX)
Ethernet Protocols	TCP/IP, Modbus TCP, FTP, SMTP, EGD, ICMP, ASCII
Remote I/O	SmartRail, SmartStix, SmartBlock, SmartMd, OCS-I/O
Removable Memory	microSD, SDHC, SDXC in FAT32 format, support for 32GB max. Application Updates, Datalogging
Audio	Beeper, line out

## USB Webcams

USB Webcams supported should support the UVC (USB Video class) protocol for the OCS to be able to display video. Most USB based video devices support this today. Special feature such as zoom and high definition are not supported by the OCS.

## XL15 Prime User Manual [MAN1485]

The User Manual includes extensive information on:

- Common %S & %SR Registers
- HSC/PWM/Totalizer/Quadrature & Accumulator Registers
- Resource Limits

## CONTROLLER OVERVIEW

### Port Controllers

1. Virtual Function Keys Slide in from the Right Upon Touching Top Right Corner of Screen
2. Optional Built-In I/O
3. High Capacity microSD Slot
4. USB C Port
5. CAN 2 Port
6. USB A Port
7. Mic Input / Audio Output
8. Dual Ethernet LAN Ports
9. DIP Switches
10. Power In
11. MJ1/2
12. MJ3
13. CAN 1 Port

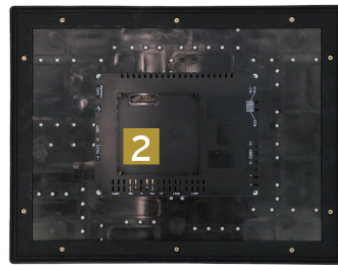

HG-669



**NOTE:** Use caution when connecting controllers to PCs via serial or USB. PCs, especially laptops may use “floating power supplies” that are ungrounded. This could cause a damaging voltage potential between the laptop and controller. Ensure the controller and laptop are grounded for maximum protection. Consider using a USB isolator due to voltage potential differences as a preventative measure.

## Power Wiring



HG-007

Primary Power Port Pins		
PIN	Signal	Description
1	Ground	Frame Ground
2	DC-	Input Power Supply Ground
3	DC+	Input Power Supply Voltage

### DC Input/Frame

- Solid/Stranded Wire: 12-24 AWG(2.5-0.2mm)
- Strip length: 0.28" (7mm)
- Torque Rating: 4.5 – 7 in•lbs (0.50 – 0.78 N•m)
- DC- is internally connected to I/O V-, but is isolated from the V- connection of both CAN1 and CAN2 ports. A Class 2 power supply must be used.

### Power Up

1. Attach ferrite core with a minimum of two turns of the DC+ and DC- signals from the DC supply that is powering the controller.

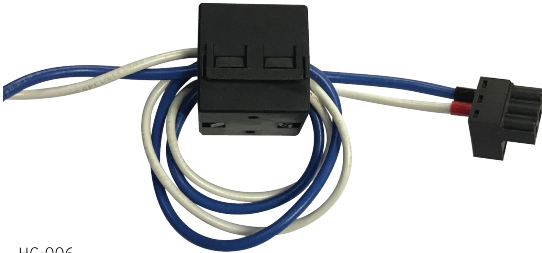

HG-006

2. Connect to earth ground.
3. Apply recommended power.

# COMMUNICATIONS

## Serial Communications

### MJ1/2 Serial Ports

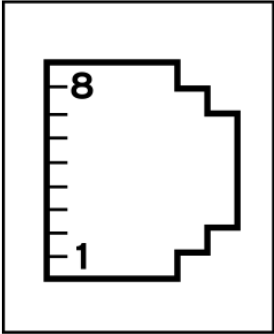
 <p>HG-008</p>	<p><b>MJ1:</b> RS-232 w/Full Handshaking  <b>MJ2:</b> RS-485 Half-Duplex</p>	MJ1 Pins			MJ2 Pins	
		PIN	SIGNAL	DIRECTION	SIGNAL	DIRECTION
		8	TXD	OUT	--	--
		7	RXD	IN	--	--
		6	0V	COMMON	0V	COMMON
		5	+5V @ 60mA	OUT	+5V @ 60mA	OUT
		4	RTS	OUT	--	--
		3	CTS	IN	--	--
		2	--	--	RX-/TX-	IN/OUT
		1	--	--	RX+/TX+	IN/OUT

### MJ3 Serial Port

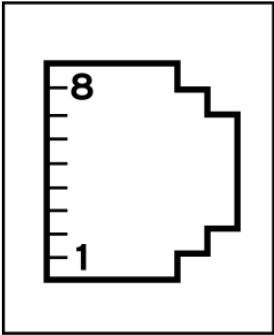
 <p>HG-008</p>	<p>2 Multiplexed Serial Ports on One Modular Jack (8 position)</p>	MJ3 PINS		
		PIN	SIGNAL	DIRECTION
		8	TXD RS-232	OUT
		7	RXD RS-232	IN
		6	0V	COMMON
		5	+5V @ 60mA	OUT
		4	TX- RS-485	OUT
		3	TX+ RS-485	OUT
		2	RX- RS-485	IN
		1	RX+ RS-485	IN

**NOTE:** Attach optional [ferrite core](#) with a minimum of two turns of serial cable.

## Ethernet

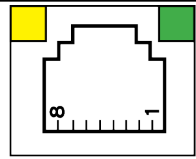
	<p><b>Green LED indicates link</b> - when illuminated, data communication is available.  <b>Yellow LED indicates activity</b> - when flashing, data is in transmission.</p>
---	---

## DIP Switches

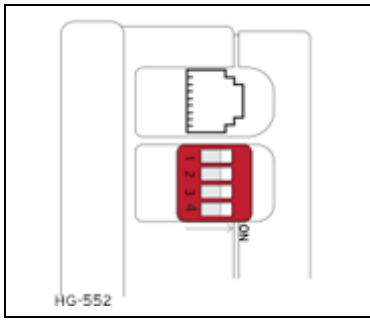
	DIP Switches			
	SWITCH	NAME	FUNCTION	DEFAULT
	1	MJ3 RS-485 Termination	ON = Terminated	OFF
	2	MJ3 Duplex	Both ON = Half Both OFF = Full	OFF
	3			OFF
	4	MJ2 RS-485 Termination	ON = Terminated	OFF

The DIP switches are used to provide a built-in termination to both the MJ1, MJ2, and MJ3 ports if needed. The termination for these ports should only be used if this device is located at either end of the multidrop/daisy-chained RS-485 network.

## CAN Communications

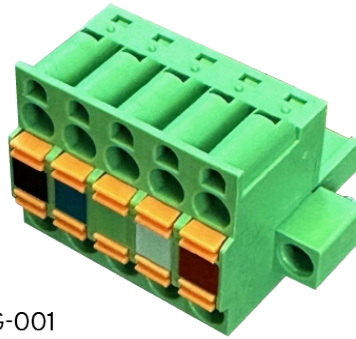

HG-001

CAN Pin Assignments		
PIN	SIGNAL	DESCRIPTION
1	V-	CAN Ground – Black
2	CN_L	CAN Data Low – Blue
3	SHLD	Shield Ground – None
4	CN_H	CAN Data High – White
5	V+ (NC)	No Connect – Red

- **Solid/Stranded Wire:** 12-24 AWG (2.5-0.2mm<sup>2</sup>).
- **Strip Length:** 0.28" (7mm).
- Locking spring-clamp, two-terminators per conductor.
- **Torque, Terminal Hold-Down Screws:** 4.5 – 7 in•lbs (0.50 – 0.78 N•m).
- V+ pin is not internally connected, the SHLD pin is connected to Earth ground via a 1MΩ resistor and 10 nF capacitor.



## DIMENSIONS & INSTALLATION

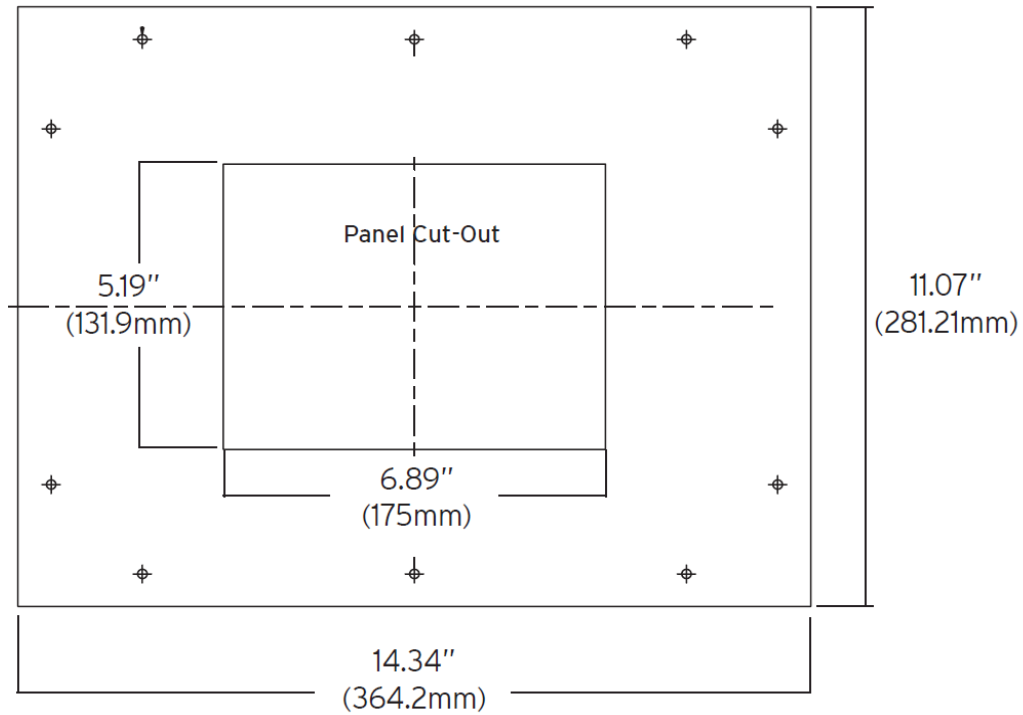
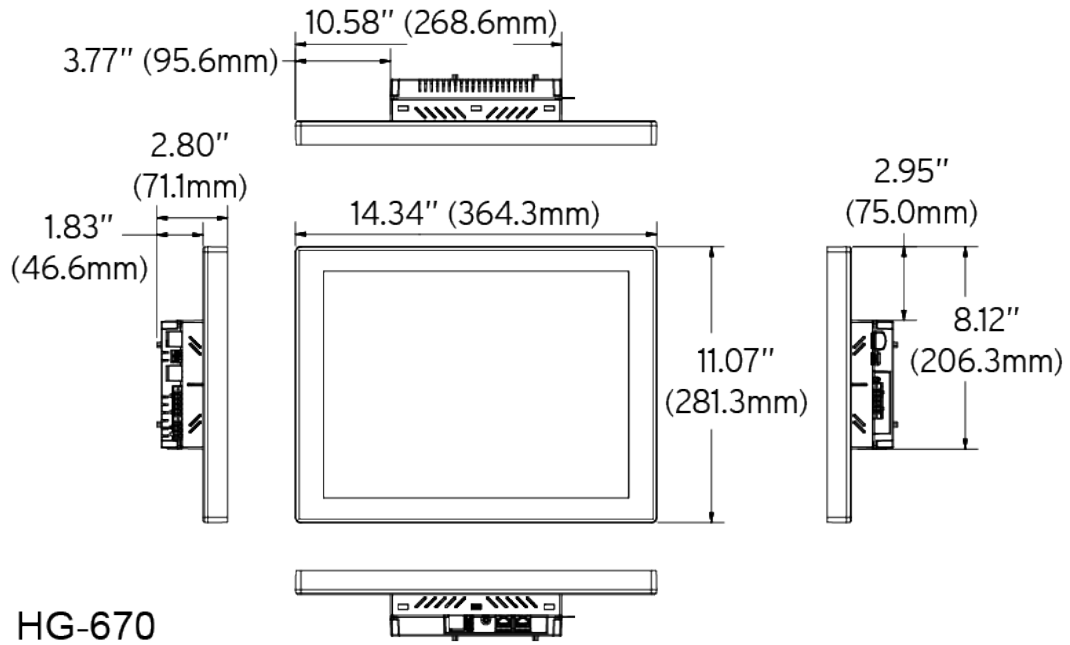

+1mm / -0mm cutout tolerance

HG-1249

**NOTE:** For mounting template, please refer to SUP1550.

## Installation Procedure

The XL15 Prime is a panel mounted device and is meant to be an enclosure suitable for the equipment, such that the equipment is only accessible with the use of a tool. The XL15 Prime is suitable for use in Class I, Division II, Groups F and G, and Class III Hazardous Locations or non-hazardous locations only.

The XL15 Prime allows unique installation options that simplify installation for systems that may not need robust vibration or water resistance.

If the system does not experience shock or vibration and will not be exposed to weather or wash down conditions the unit can be installed by cutting the rectangular opening and installing the four supplied clips.

For systems that may experience shock or vibration or are installed outdoors or in wash down environments, the rectangular cut and clips are used and perimeter holes must be drilled in the panel. The supplied studs are then inserted into the perimeter of the controller and supplied nuts will secure the perimeter of the unit to the panel.

Please reference the XL15 Prime Quick Reference Guide (SUP1550) for Mounting Template.

1. Remove all connectors from the XL15 Prime OCS unit.
2. Carefully locate an appropriate place to mount the XL15 Prime. Be sure to leave enough room for insertion and removal of the microSD card. Also leave enough room for the insertion and removal of USB flash drives and wiring
3. Carefully cut the host panel per the diagram, with a tolerance of +1.00 mm / -0 mm. Remove any burrs/sharp edges and ensure the panel is not warped in the cutting process.
  - If the opening is too large, water may leak into the enclosure, potentially damaging the OCS.
  - If the opening is too small, the OCS may not fit through the hole without damage.
4. Make sure the outer gaskets are installed on the XL15 Prime OCS and are free from dust and debris. Check that the corners of the gasket are secure. Insert the OCS through the panel cutout (from the front). The gasket needs to be between the host panel and the OCS.
5. Insert each of the four (4) mounting clips into the slots in the XL15 Prime OCS case. One clip should be installed on each corner. Lightly tighten each screw so the clip is held in place.
6. Tighten the screws on the clips such that the gasket is compressed against the panel. Recommended torque is 7-10 in•lbs (0.79-1.13 N•m). If the perimeter studs are needed, it is recommended to use a thread locker (similar to 242 Blue Loctite). Use supplied lock washers and nut.

**NOTE:** Recommended perimeter stud torque is 3-4 in•lbs (0.34- 0.45 N•m).

7. Reinstall the I/O Removable Terminal Blocks (if applicable).  
Connect communications cables to the serial port, USB ports, Ethernet port, and CAN ports, as required.

## SAFETY & MAINTENANCE

### Warnings

1. To avoid the risk of electric shock or burns, always connect the safety (or earth) ground before making any other connections.
2. To reduce the risk of fire, electrical shock, or physical injury, it is strongly recommended to fuse the voltage measurement inputs. Be sure to locate fuses as close to the source as possible.
3. Replace fuse with the same type and rating to provide protection against risk of fire and shock hazards.
4. In the event of repeated failure, do **NOT** replace the fuse again as repeated failure indicates a defective condition that will **NOT** clear by replacing the fuse.
5. Only qualified electrical personnel familiar with the construction and operation of this equipment and the hazards involved should install, adjust, operate, or service this equipment.
6. Read and understand this manual and other applicable manuals in their entirety before proceeding. Failure to observe this precaution could result in severe bodily injury or loss of life.
7. **WARNING:** Battery may explode if mistreated. Do not recharge, disassemble, or dispose of in fire.
8. **WARNING:** EXPLOSION HAZARD- Batteries must only be changed in an area known to be non-hazardous.
9. **WARNING:** Do not disconnect while circuit is live unless area is know to be non-hazardous.

### FCC Compliance

This device complies with Part 15 of the FCC Rules. Operation is subject to the following two conditions:

1. This device may not cause harmful interference.
2. This device must accept any interference received, including interference that may cause undesired operation.

### Precautions

All applicable codes and standards need to be followed in the installation of this product. Adhere to the following safety precautions whenever any type of connection is made to the module:

1. Connect the safety (earth) ground on the power connector first before making any other connections.
2. When connecting to the electric circuits or pulse-initiating equipment, open their related breakers.
3. Do NOT make connection to live power lines.
4. Make connections to the module first; then connect to the circuit to be monitored.
5. Route power wires in a safe manner in accordance with good practice and local codes.
6. Wear proper personal protective equipment including safety glasses and insulated gloves when making connections to power circuits.
7. Ensure hands, shoes, and floor are dry before making any connection to a power line.
8. Make sure the unit is turned OFF before making connections to terminals.
9. Make sure all circuits are de-energized before making connections.
10. Before each use, inspect all cables for breaks or cracks in the insulation. Replace immediately if defective.
11. Use copper conductors in field wiring only, 60/75°C.



- 12. Use caution when connecting controllers to PCs via serial or USB. PCs, especially laptops, may use “floating power supplies” that are ungrounded. This could cause a damaging voltage potential between the laptop and controller. Ensure the controller and laptop are grounded for maximum protection. Consider using a USB isolator due to voltage potential differences as a preventative measure.

## Technical Support

North America	Europe
1 (317) 916-4274 1 (877) 665-5666 <a href="http://www.hornerautomation.com">www.hornerautomation.com</a> <a href="mailto:APGUSATechSupport@heapg.com">APGUSATechSupport@heapg.com</a>	+353 (21) 4321-266 <a href="http://www.hornerautomation.eu">www.hornerautomation.eu</a> <a href="mailto:technical.support@horner-apg.com">technical.support@horner-apg.com</a>