



IO-Link Configuration Software

Instruction Manual

Original Instructions
228876 Rev. B
29 August 2022
© Banner Engineering Corp. All rights reserved



228876

Contents

1 Software Description	3
1.1 Overview	3
2 Specifications and Requirements	4
2.1 IO-Link Configuration Software PC Requirements.....	4
2.2 Adapter Cable – Required for use with IO-Link Configuration	4
2.2.1 Model.....	4
2.3 BWA-UCT-900 Adapter Cable Specifications	4
2.4 Banner Engineering Corp. Software Copyright Notice.....	5
3 Installation Instructions	6
3.1 Install the Software	6
3.2 Connect the Cables	6
3.2.1 IO-Link Device Connection	6
3.3 Load an IO-DD and Connect to Banner IO-Link Devices.....	7
3.3.1 Read and Change the Banner IO-Link Device Configuration	9
3.3.2 Process Data	10
4 Read and Change the Banner IO-Link Master Port Configuration	11
5 Accessories	13
5.1 IO-Link Hardware	13
6 Product Support and Maintenance	14
6.1 Maintenance	14
6.1.1 Update the Software.....	14
6.2 IO-Link Configuration Release Notes	14
6.3 Contact Us	14
6.4 Banner Engineering Corp. Limited Warranty	14
6.5 FCC Part 15 Class B	14
6.6 Industry Canada.....	15

1 Software Description

Software that Enables the Field Configuration of Banner IO-Link Masters and Banner IO-Link Devices

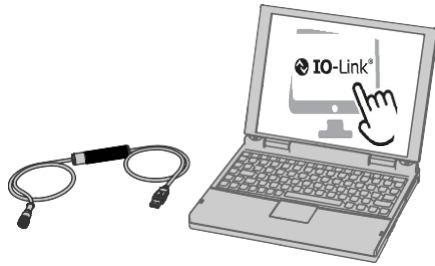

- Allows the configuration of Banner IO-Link devices
- Free to download and available on the product pages for the DXMR90-4K, R90C-4K-MQ, and R45C-2K-MQ IO-link masters
- Works on Microsoft® Windows® 7 and 10 ¹
- BWA-UCT-900 cable required to connect PC-based IO-Link Configuration Software to Banner IO-Link masters and Banner IO-Link devices



Note: Administrative rights are required to install the IO-Link Configuration Software.

1.1 Overview

Banner's IO-Link Configuration Software offers an easy way to configure Banner IO-Link masters and Banner IO-Link devices, offering users full control of master and device configuration. The easy-to-use software provides a variety of tools and works with the DXMR90-4K, R90C-4K-MQ, and R45C-2K-MQ IO-Link Masters.

Configure Banner IO-Link masters and Banner IO-Link devices using the free IO-Link Configuration Software, available for download at <https://www.bannerengineering.com/us/en/products/part.811445.html>.

¹ Microsoft and Windows are registered trademarks of Microsoft Corporation in the United States and/or other countries.

2 Specifications and Requirements

2.1 IO-Link Configuration Software PC Requirements

Operating System

Microsoft® Windows® operating system versions 7 or 10 ²

Hard Drive Space

120 MB

USB

Available USB port

Screen Resolution

1366 × 768 full-color minimum

Third-Party Software

.NET version 4.6.2 or higher



Important: Administrative rights are required to install the IO-Link Configuration Software.

2.2 Adapter Cable – Required for use with IO-Link Configuration

An adapter cable, model BWA-UCT-900, is required for use with the IO-Link Configuration Software. Use the adapter cable to connect Banner IO-Link devices to read, write, and preview device configurations.



- Connects Banner IO-Link masters to the PC-based IO-Link Configuration Software

2.2.1 Model

Model	Adapter	Length	Connections
BWA-UCT-900	RS-485 to USB	1 m (3.28 ft)	USB and 5-pin M12 quick disconnect

2.3 BWA-UCT-900 Adapter Cable Specifications

Input Voltage

5 V DC from USB Type A connector

Certifications

Output Voltage

24 V DC power output for a single device transmitting at 1 Watt

Operating Conditions

–40 °C to +80 °C (–40 °F to +176 °F)
95% maximum relative humidity (non-condensing)

² Microsoft® and Windows® are registered trademarks of Microsoft® Corporation in the United States and/or other countries.

2.4 Banner Engineering Corp. Software Copyright Notice

This software is protected by copyright, trade secret, and other intellectual property laws. You are only granted the right to use the software and only for the purposes described by Banner. Banner reserves all other rights in this software. For so long as you have obtained an authorized copy of this software directly from Banner, Banner grants you a limited, nonexclusive, nontransferable right and license to use this software.

You agree not to use, nor permit any third party to use, this software or content in a manner that violates any applicable law, regulation or terms of use under this Agreement. You agree that you will not reproduce, modify, copy, deconstruct, sell, trade or resell this software or make it available to any file-sharing or application hosting service.

Disclaimer of Warranties. Your use of this software is entirely at your own risk, except as described in this agreement. This software is provided "AS-IS." To the maximum extent permitted by applicable law, Banner, its affiliates, and its channel partners disclaim all warranties, expressed or implied, including any warranty that the software is fit for a particular purpose, title, merchantability, data loss, non-interference with or non-infringement of any intellectual property rights, or the accuracy, reliability, quality or content in or linked to the services. Banner and its affiliates and channel partners do not warrant that the services are secure, free from bugs, viruses, interruption, errors, theft or destruction. If the exclusions for implied warranties do not apply to you, any implied warranties are limited to 60 days from the date of first use of this software.

Limitation of Liability and Indemnity. Banner, its affiliates and channel partners are not liable for indirect, special, incidental, punitive or consequential damages, damages relating to corruption, security, loss or theft of data, viruses, spyware, loss of business, revenue, profits, or investment, or use of software or hardware that does not meet Banner minimum systems requirements. The above limitations apply even if Banner and its affiliates and channel partners have been advised of the possibility of such damages. This Agreement sets forth the entire liability of Banner, its affiliates and your exclusive remedy with respect to the software use. You agree to indemnify and hold Banner and its affiliates and channel partners harmless from any and all claims, liability and expenses, including reasonable attorney's fees and costs, arising out of your use of the Services or breach of this Agreement (collectively referred to as "Claims"). Banner reserves the right at its sole discretion and at its own expense, to assume the exclusive defense and control of any Claims. You agree to reasonably cooperate as requested by Banner in defense of any Claims.

3 Installation Instructions

3.1 Install the Software



Important: Administrative rights are required to install the IO-Link Configuration Software.

1. Download the latest version of the software from <https://www.bannerengineering.com/us/en/products/part.811445.html>.
2. Navigate to the downloaded file **IOLConfigInstaller.exe**.
3. Double-click the installer to open **Banner IO-Link Configuration Software Setup**.
4. Accept the terms in the License Agreement by selecting the checkbox.
5. Click **Install** to install the software.
6. Depending on the system settings, a pop-up window may appear prompting to allow the IO-Link Configuration Software to make changes to the computer. Click **Yes**.
7. Click **Close** to exit the installer after installation is complete.

3.2 Connect the Cables

1. With the BWA-UCT-900 adapter cable, plug the M12 connector into male connector of the IO-Link master.
2. Plug the USB connector of the BWA-UCT-900 into the PC.
3. Plug the power cable of the BWA-UCT-900 into a wall outlet.

3.2.1 IO-Link Device Connection

To configure Banner IO-Link devices:

1. Connect the Banner IO-Link device or devices to the ports on the DXMR90-4K, the R45C-2K-MQ or R90C-4K-MQ IO-Link masters using an M12 cordset.
2. Plug the M12 connector of the BWA-UCT-900 adapter cable into the male M12 communication port on the R45C-2K-MQ or R90C-4K-MQ.
3. Plug the USB connector on the BWA-UCT-900 into the PC.

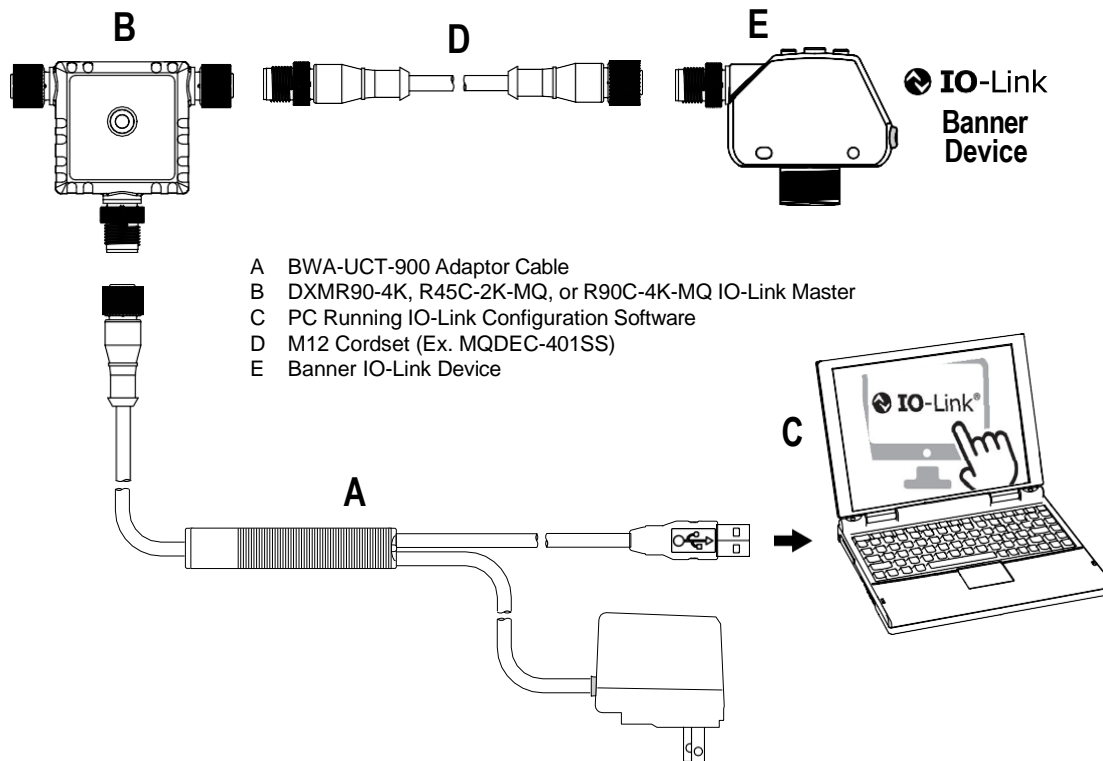

3.3 Load an IODD and Connect to Banner IO-Link Devices

After connecting a Banner IO-Link master to a PC, follow these steps to connect IO-Link devices to the IO-Link Configuration Software.

1. Download the Banner IO-Link device IODDs.
 - a) Go to www.bannerengineering.com.
 - b) Search for the desired Banner IO-Link devices.
 - c) Click **Product Detail**.

Figure 1. Search for the Product (LM150KIQP shown)

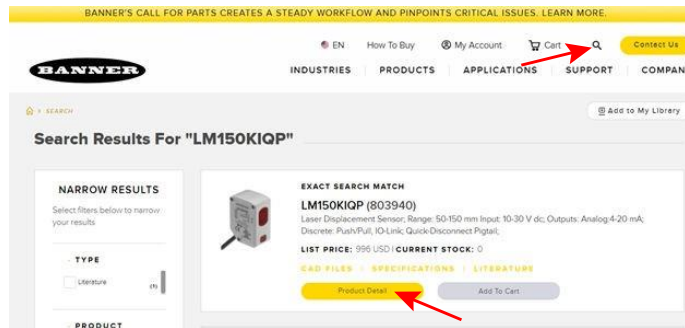

- d) On the product page, under **Downloads**, navigate to the IODD file and click the download button.

Figure 2. Download the IODD Files



2. Extract the downloaded IODD zip file and save it to a desired location.
Repeat this process for every Banner IO-Link device that is connected to the IO-Link master.
3. Open the IO-Link Configuration Software and click **File > Load IODD** in the upper left corner of the window.

Figure 3. Load IODD

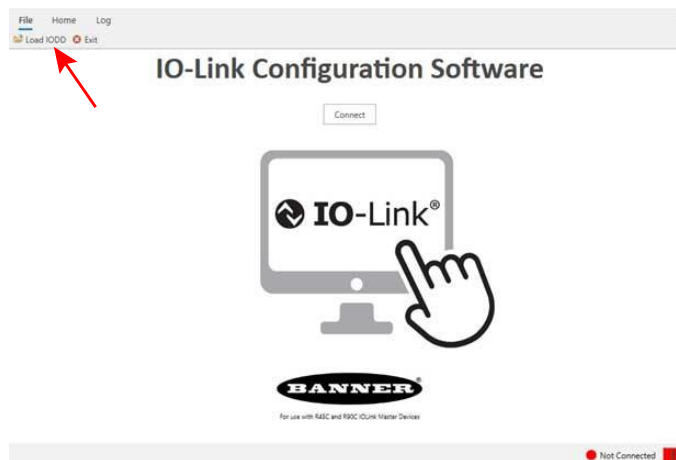

A File Explorer window opens.

4. Navigate to where the IODD file was extracted to in File Explorer and click on it.
5. Click **Open** in File Explorer.

MAN1417-01_IOLINK_Config

Figure 4. Open the IODD File

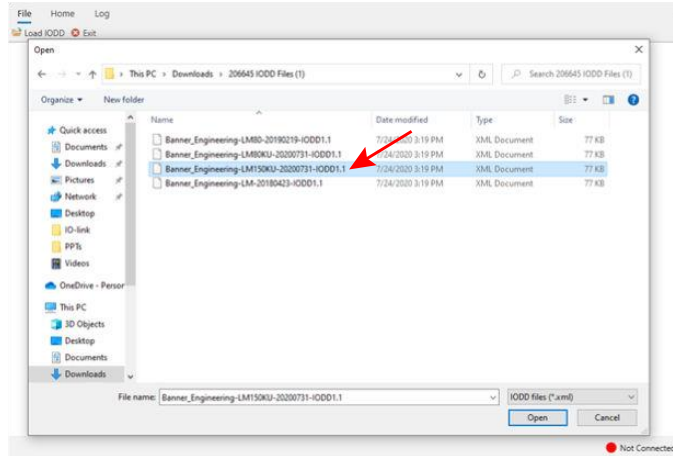

- The file explorer window closes, and the IODD file loads into the IO-Link Configuration Software.
- Click **Connect** in the IO-Link Configuration Software window.

Figure 5. Connect the Device

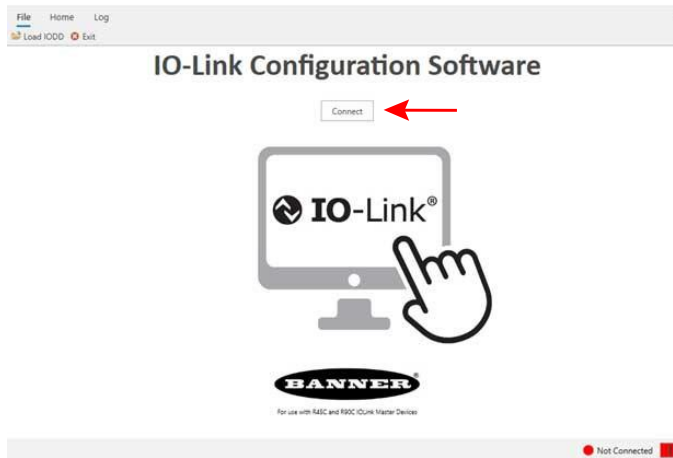

The Banner IO-Link devices are now connected to the IO-Link Configuration Software. The connected IO-Link devices appear in new tabs within the software window, and the status in the bottom right corner now reads as **Connected**.

Figure 6. Connected

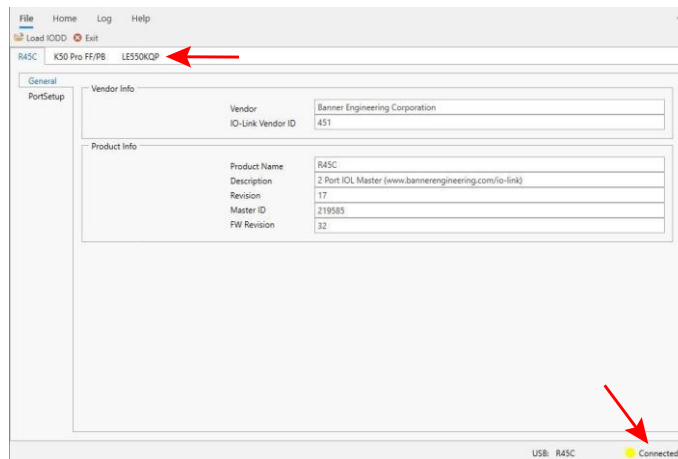

3.3.1 Read and Change the Banner IO-Link Device Configuration

1. Select the device tab in the software window, and click **Parameters** in the left menu. **Parameters** is used to read and change the Banner IO-Link device configuration. After clicking on **Parameters**, the Parameters pane opens within the device tab.

Figure 7. Parameters

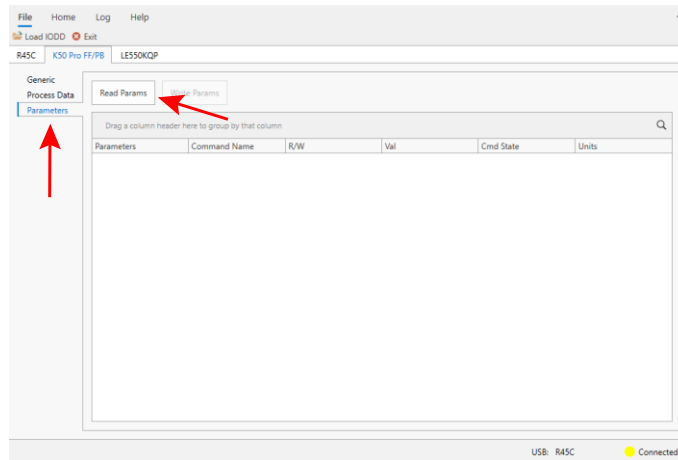

2. Click **Read Params** to read the current configuration of the connected Banner IO-Link device.

Figure 8. Read Params

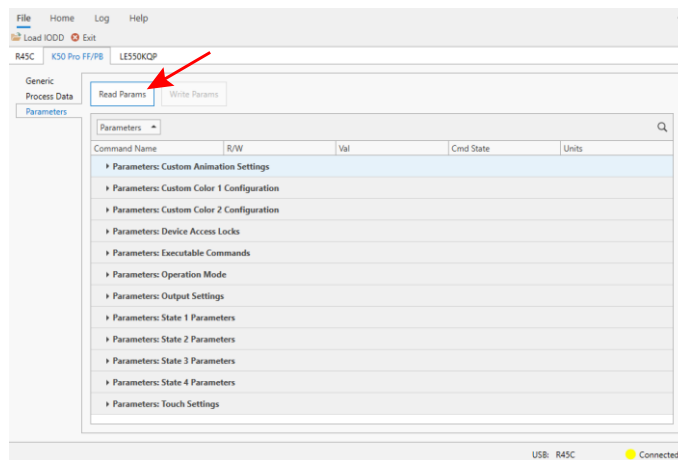

This displays the current IO-Link configuration information in the Parameters pane, along with all of the device's available settings.

3. If desired, make any changes to the Banner IO-Link device's configuration in this pane using the available settings.
4. If changes were made to the settings, write the changes to the device by clicking **Write Params**.

Figure 9. Write Params

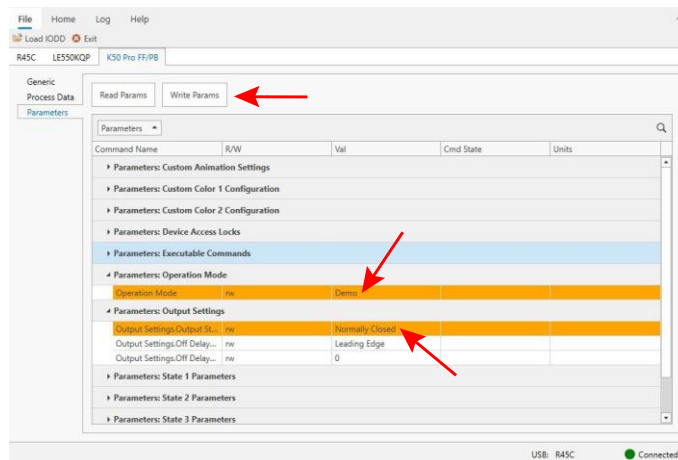

3.3.2 Process Data

Process data refers to the information that the device reads and transmits to the master, such as the distance reading on a laser measurement sensor.

Process data can also refer to information that is transmitted to the device from the master, such as messages sent to a tower light indicating which color segments should be illuminated.

Cyclic and acyclic process data can be transferred between an IO-Link master and an IO-Link device. By clicking **Process Data** in the left menu, the user is able to view the live process data of the Banner IO-Link device connected to the IO-Link master.

Process Data IN is data that is sent from the IO-Link device to the IO-Link master.

Process Data OUT is data that is sent from the IO-Link master to the IO-Link device.

Figure 10. Process Data

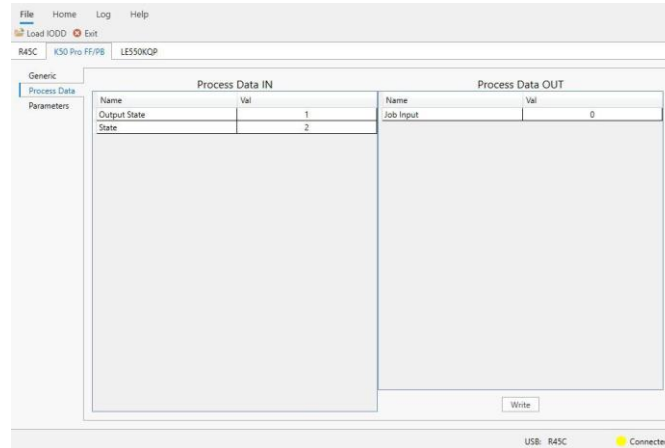

4 Read and Change the Banner IO-Link Master Port Configuration

The IO-Link Configuration Software has a special tab for configuring the port settings on the IO-Link master. To access, click on the IO-Link master tab and select **PortSetup**.

Figure 11. IO-Link Master Port Setup

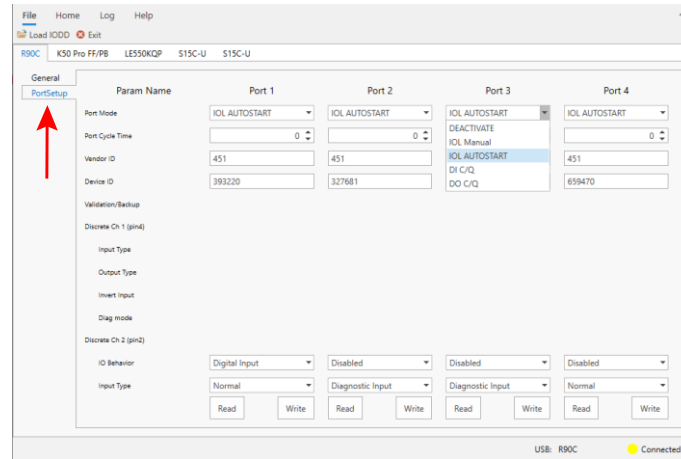

The operating mode can be configured for any port on the IO-Link master. The following modes can be used:

Deactivated

Use deactivated mode for any unused IO-link master ports if a device is not connected.

IO-Link Manual

The IO-Link master only connects IO-Link devices that have a certain vendor ID and device ID (1: IOL_MANUAL).

IO-Link Autostart

The IO-Link master connects to every connected IO-Link device (2: IOL_AUTOSTART).

Digital Input

The IO-Link port functions as a standard digital input (3: DI_C/Q).

Digital Output

The IO-Link port functions as a standard digital output (4: DO_C/Q).

When the backup function of the IO-Link master is used, the IO-Link master automatically provides the saved parameters to the new device after replacement. This makes IO-Link device replacement seamless in IO-Link applications. Another common industry term for this function is *data storage mode*.

. Backup+Restore Mode

If a port on the IO-Link master is set to Backup+Restore, then the new device added to the IO-Link port takes in the same device configuration as the device that was just replaced, as the IO-Link master had stored the last configuration change by a backup (3: Type compatible Device V1.1, Backup + Restore).

. Restore

If the port on the IO-Link master port is set to Restore, then the new device takes in the configuration according the settings saved in the master at the time of the last backup. Because possible configuration changes were not saved in the master, a different behavior from the previous one before the replacement may occur (4: Type compatible Device V1.1, Restore).

Make changes to the ports' settings by selecting the drop-down menus for each port. To read the current configuration of each port, select the applicable **Read** button. After making the desired changes to the port settings, select the applicable **Write** button.

Figure 12. Write Port Settings

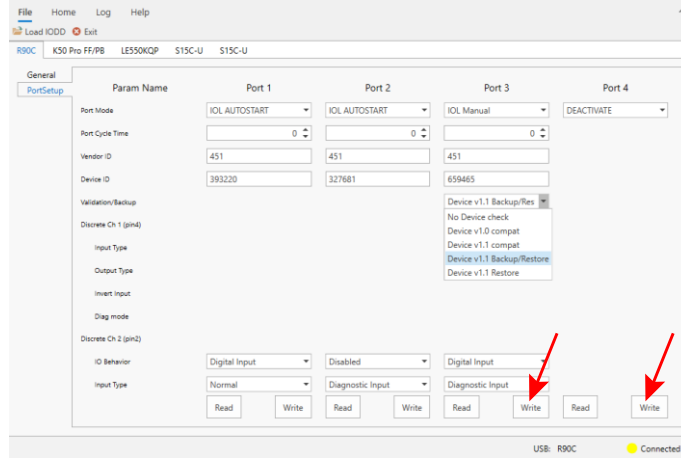

5 Accessories

5.1 IO-Link Hardware

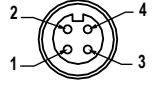
4-Pin Threaded M12 RS-485 to USB Adapter Cordset, with Wall Plug				
Model	Length	Style	Dimensions	Pinout (Female)
BWA-UCT-900	1 m (3.28 ft)	Straight		 <p>1 = Brown 2 = White 3 = Blue 4 = Black</p>

6 Product Support and Maintenance

6.1 Maintenance

Maintenance tasks include updating the IO-Link Configuration Software as new versions become available.

6.1.1 Update the Software

The current version of the IO-Link Configuration Software is available for download from <https://www.bannerengineering.com/us/en/products/part.811445.html>.

When connected to a network, if an IO-Link Configuration Software update is available, a red icon  displays in the bottom right corner of the IO-Link Configuration Software. Click this icon to update the software to the latest version.

6.2 IO-Link Configuration Release Notes

Version	Devices	General
2.0.7	Added support for DXMR90-4K IO-Link Master	Can now connect multiple devices and configure multiple ports
1.0.16	Supports R45C and R90C IO-Link Master devices	Initial release

6.3 Contact Us

Banner Engineering Corp. headquarters is located at:

9714 Tenth Avenue North
Minneapolis, MN 55441, USA
Phone: + 1 888 373 6767

For worldwide locations and local representatives, visit www.bannerengineering.com.

6.4 Banner Engineering Corp. Limited Warranty

Banner Engineering Corp. warrants its products to be free from defects in material and workmanship for one year following the date of shipment. Banner Engineering Corp. will repair or replace, free of charge, any product of its manufacture which, at the time it is returned to the factory, is found to have been defective during the warranty period. This warranty does not cover damage or liability for misuse, abuse, or the improper application or installation of the Banner product.

THIS LIMITED WARRANTY IS EXCLUSIVE AND IN LIEU OF ALL OTHER WARRANTIES WHETHER EXPRESS OR IMPLIED (INCLUDING, WITHOUT LIMITATION, ANY WARRANTY OF MERCHANTABILITY OR FITNESS FOR A PARTICULAR PURPOSE), AND WHETHER ARISING UNDER COURSE OF PERFORMANCE, COURSE OF DEALING OR TRADE USAGE.

This Warranty is exclusive and limited to repair or, at the discretion of Banner Engineering Corp., replacement. **IN NO EVENT SHALL BANNER ENGINEERING CORP. BE LIABLE TO BUYER OR ANY OTHER PERSON OR ENTITY FOR ANY EXTRA COSTS, EXPENSES, LOSSES, LOSS OF PROFITS, OR ANY INCIDENTAL, CONSEQUENTIAL OR SPECIAL DAMAGES RESULTING FROM ANY PRODUCT DEFECT OR FROM THE USE OR INABILITY TO USE THE PRODUCT, WHETHER ARISING IN CONTRACT OR WARRANTY, STATUTE, TORT, STRICT LIABILITY, NEGLIGENCE, OR OTHERWISE.**

Banner Engineering Corp. reserves the right to change, modify or improve the design of the product without assuming any obligations or liabilities relating to any product previously manufactured by Banner Engineering Corp. Any misuse, abuse, or improper application or installation of this product or use of the product for personal protection applications when the product is identified as not intended for such purposes will void the product warranty. Any modifications to this product without prior express approval by Banner Engineering Corp will void the product warranties. All specifications published in this document are subject to change; Banner reserves the right to modify product specifications or update documentation at any time. Specifications and product information in English supersede that which is provided in any other language. For the most recent version of any documentation, refer to: www.bannerengineering.com.

For patent information, see www.bannerengineering.com/patents.

6.5 FCC Part 15 Class B

This equipment has been tested and found to comply with the limits for a Class B digital device, pursuant to part 15 of the FCC Rules. These limits are designed to provide reasonable protection against harmful interference in a residential installation. This equipment generates, uses and can radiate radio frequency energy and, if not installed and used in accordance with the instructions, may cause harmful interference to radio communications. However, there is no guarantee that interference will not occur in a particular installation. If this equipment does cause harmful interference to radio or television reception, which can be determined by turning the equipment off and on, the user is encouraged to try to correct the interference by one or more of the following measures:

- Reorient or relocate the receiving antenna.
- Increase the separation between the equipment and receiver.
- Connect the equipment into an outlet on a circuit different from that to which the receiver is connected.
- Consult the dealer or an experienced radio/TV technician for help

6.6 Industry Canada

This device complies with CAN ICES-3 (B)/NMB-3(B). Operation is subject to the following two conditions: 1) This device may not cause harmful interference; and 2) This device must accept any interference received, including interference that may cause undesired operation.

Cet appareil est conforme à la norme NMB-3(B). Le fonctionnement est soumis aux deux conditions suivantes : (1) ce dispositif ne peut pas occasionner d'interférences, et (2) il doit tolérer toute interférence, y compris celles susceptibles de provoquer un fonctionnement non souhaité du dispositif.