



SmartMod

Digital Input/Output Module

HE359DIQ516

-Four Isolated Digital Inputs
-Eight Isolated Digital Outputs



1 Specifications

DIQ516		DIQ516	
Inputs per Module (Commons)	4 (1 Common)	Sample Time (PLC Update Rate)	Min. 20 ms - Determined by Communications w/OCS
Input Voltage Range	12/24 VDC	Terminal Type	Screw Type, Removable
Impedance	4.7 kΩ	Storage Temp.	-40° to 85°C
Peak Voltage	30 VDC	Operating Temp.	-10° to 60°C
ON voltage level	10 VDC	Relative Humidity	0 to 90% Non-condensing
OFF voltage level	0-3 VDC	Dimensions W x H x D	17.5 mm x 100 mm x 120 mm 0.69" x 3.94" x 4.72"
Outputs per Module	8	Weight	210 g (8.4 oz.)
Max Switching Power	2A @ 250 VAC 2A @ 30 VDC	Communication	Modbus/RTU (binary) RS-485 half duplex
Minimum Load	5 VDC, 10 mA	Factory Default Communications Parameters	38400 baud, N, 8, 1, no h/s Default Modbus ID 1
Maximum Voltage	250 VAC, 110 VDC	Supported Modbus Commands	1,2,3,4,5,6,8,15,16
Required Power (Steady State)	45 mA @ 24VDC, typical	Isolation	2000 VAC for 60 seconds (Input/Power & Input/Comms)
Required Power (Inrush)	Negligible	CE & UL Compliance	https://hornerautomation.com/certifications/ http://www.horner-apg.com/en/support/certification.aspx

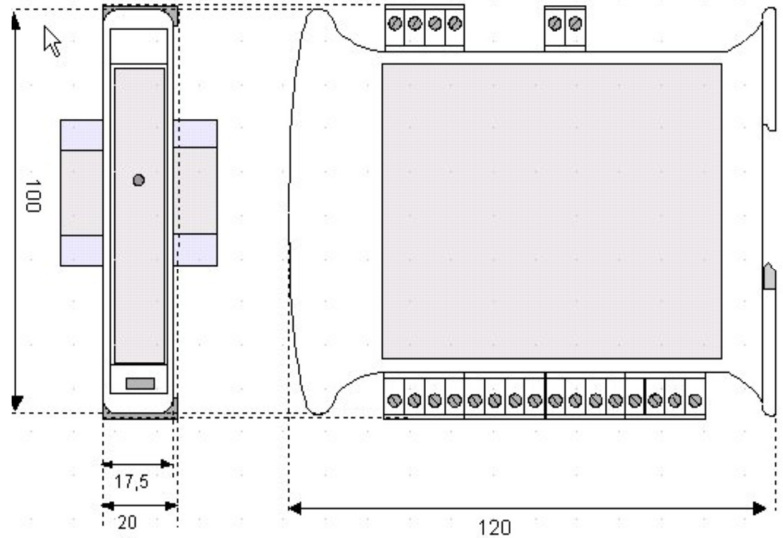

Dimensions in inches are 0.69" W x 3.95" H x 4.72" D
Note: Number of I/O terminal connections varies from model to model.

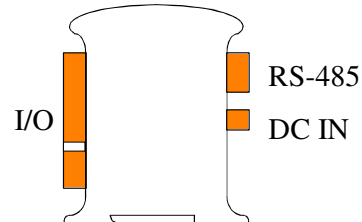

2. Wiring – I/O

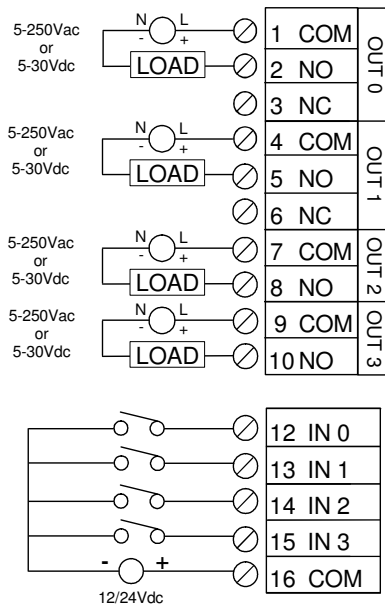

Pin #	DIQ512		Pin #	DIQ512																													
1	COM	OUT 0	9	COM	OUT 3																												
2	N. O.		3	N. C.		4	COM	OUT 1	12	INPUT 0	Note: Each Output COM isolated	5	N. O.	6	N. C.	7	COM	OUT 2	13	INPUT 1	8	N.O.	14	INPUT 2				15	INPUT 3				16
3	N. C.																																
4	COM	OUT 1	12	INPUT 0	Note: Each Output COM isolated																												
5	N. O.		6	N. C.		7	COM	OUT 2	13	INPUT 1		8	N.O.	14	INPUT 2				15	INPUT 3				16	COM								
6	N. C.																																
7	COM	OUT 2	13	INPUT 1																													
8	N.O.		14	INPUT 2																													
			15	INPUT 3																													
			16	COM																													

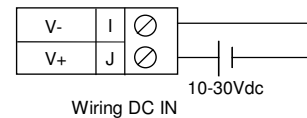
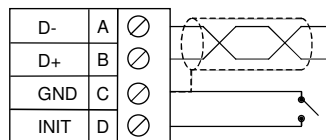

Notes:

Both ends of the RS-485 network should be terminated with a 100 Ω, 1/4W, 1% resistor. Many OCS controllers feature dip switches or jumpers which enable appropriate termination if the OCS is located on a network end.

3. Init Default Setup

Communication parameters will be set to INIT default after performing the procedure:

1. Install jumper between INIT and GND terminals of the RS-485 port.
2. Apply power to SmartMod unit.
3. Read parameter words to see current parameters.
4. Write changes if necessary.

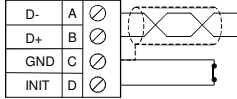

The INIT Default RS485 Settings Are:

Modbus ID = 1
 Baud rate = 9600
 Parity = None
 Stop Bits = 1
 Data Bits = 8
 No handshake

Note: There are 2 types of default settings possible:
 1. Factory default as described in section 1 (Specifications)
 2. Default after INIT as described in section 3 (INIT Default Setup)

4. Configuration DATA

SmartMod Configuration settings are mapped into Modbus Register space. This configuration data may be modified with any Modbus/RTU Master device. For convenience, Horner APG has developed a variety of Cscape application files, which allow an OCS to act as a SmartMod configuration device. Initial configuration of SmartMod module should be done on an individual basis, since all modules come from the factory with a default Modbus ID of 1. Once each module on the network has its own unique Modbus ID, further configuration adjustments can be made with the entire network powered.

All configuration parameters listed below are stored in EPROM. This means they should not be constantly rewritten.

Configuration Parameters – Registers 40001 through 40013				
Modbus Register	Description	Min	Max	Default
40001-40005	Reserved			
40006	Communications Parameters	See Table		38.4 kBd, N, 8, 1, RTU Mode
40007	Modbus ID	1	255	1
40008	Rx/Tx Delay (in 2 ms steps)	0	255	0 ms
40009	Input Coils	Not Configuration Data – See I/O Data		
40010	Output Coils			
40011	Coils			
40012	Power Up/Safe	See Table		0
40013	Watchdog Timer *in 0.5 s steps)	0	255	10 (5 s)

Register 40006 (Communications Parameters) Bit Definition							
Bits 15 - 7	Bit 6	Bit 5	Bit 4	Bit 3	Bit 2	Bit 1	Bit 0
Unused	Mode	Parity		Data Bits	Baud Rate		
	0 = ASCII Mode	Value	Meaning	0 = 7 Data Bits	Value	Meaning	
	1 = RTU Mode	0	Mark	1 = 8 Data Bits	0	1200 Bd	
		1	Even		1	2400 Bd	
		2	Odd		2	4800 Bd	
		3	Space		3	9600 Bd	
					4	19200 Bd	
					5-7	38400 Bd	

NOTE: Data bits number is ignored, in ASCII mode it is fixed at 7 and in RTU mode it is fixed to 8. In RTU mode the parity bit is ignored (parity is fixed at NONE).

5. Input/Output DATA

SmartMod Digital I/O data utilizes both Modbus Registers (40009-40011) and Coils (1-35). It is possible to access all data using Registers only, because the Coils data can be accessed through Registers.

The following tables lists all Modbus I/O data available.

Register 40009 Definition (Mirror of Digital Input Coils)																
This register shows digital inputs state (0 = OFF, 1 = ON). The same values can be read by the coils table, of which this register is a mirror. These values are Read Only .																
Bit	15	14	13	12	11	10	9	8	7	6	5	4	3	2	1	0
Descr.	Low Rise Latch				Input				Sync.				High Rise Latch			
Channel	3	2	1	0	3	2	1	0	3	2	1	0	3	2	1	0
Coil	8	7	6	5	4	3	2	1	16	15	14	13	12	11	10	9

Register 40010 Definition (Mirror of Digital Output Coils)																
This register shows digital outputs state (0 = OFF, 1 = ON). The same values can be read by the coils table, of which this register is a mirror. These values are Read Only .																
Bit	15	14	13	12	11	10	9	8	7	6	5	4	3	2	1	0
Channel	7	6	5	4	3	2	1	0	-	-	-	-	-	-	-	-
Coil	24	23	22	21	20	19	28	17	-	-	-	-	-	-	-	-

Register 40011 Definition (Mirror of Watchdog Coils)																
This register shows digital state of watchdog coils (0 = OFF, 1 = ON). These values are Read/Write .																
Bit	15	14	13	12	11	10	9	8	7	6	5	4	3	2	1	0
Coil	-	-	-	-	-	35	34	33	-	-	-	-	-	-	-	-

I/O Register Data Summary (Registers 40009-40011)							
Modbus Register	Description	Access	Bits 0-7 & 12-15	Bit 11	Bit 10	Bit 9	Bit 8
40009	Mirror of Input Coil Data	Read-only	unused	In 3	In 2	In 1	In 0
40010	Mirror of Output Data	Read/Write	unused	Out 3	Out 2	Out 1	Out 0
40011	Mirror of WatchDog Data	Read/Write	unused	PwrUp Event	W.D.* Event	W.D.* Enblnd	

* W.D. – Watchdog

Register 40012 (Power Up/Safe) Bit Definition									
Bit 15-12	Bit 11	Bit 10	Bit 9	Bit 8	Bit 4-7	Bit 3	Bit 2	Bit 1	Bit 0
Unused	Out 3	Out 2	Out 1	Out 0	Unused	Out 3	Out 2	Out 1	Out 0
PowerUp Value					Safe Valve				

Modbus Coil	Description	Access	Watchdog Event & Power-up Event Operation
00001	Input 0	Read-only	If Coil 33 (Watchdog Enabled) is set, Coil 34 (Watchdog Event) will set if the Watchdog Timeout value is exceeded. The Watchdog Timeout value is set in Register 40013. When set, Coil 34 can be reset by the controller when normal communications resumes.
00002	Input 1	Read-only	
00003	Input 2	Read-only	
00004	Input 3	Read-only	
00005-00016	Reserved*		
000017	Output 0	Read/Write	
000018	Output 1	Read/Write	
000019	Output 2	Read/Write	
000020	Output 3	Read/Write	
000021	Output 4	Read/Write	
000022	Output 5	Read/Write	The Power-up Event (Coil 35) is set every time the power is applied. It can be cleared by the controller if desired.
000023	Output 6	Read/Write	
000024	Output 7	Read/Write	
00021-00032	Reserved*		
00033	Watchdog Enabled	Read/Write	
00034	Watchdog Event	Read/Write	
00035	Power-up Event	Read/Write	

*See definition of registers 40009 and 40010 above for more information.

6. Watchdog

The module has been provided with a Host Watchdog timer which, when it is enabled, issues an alarm event each time the communication between the module and the host is inactive for a period time greater than the programmed one (40009). When the alarm is activated, the values of the outputs are automatically converted to the preset safety values to avoid damage to the system in case of a fault occurring. Also, under the alarm condition the green LED on the front of the module blinks and the "Watchdog Event" coil is forced to a value of 1. There is also a Module Watchdog timer that monitors the internal CPU work and activates when the CPU doesn't function correctly. After the reset, all outputs will assume their initial default value ("power up value"), this may be different to the output value after the reset.

Register 40013 Definition		
The Watchdog Timeout value is set in Modbus register 40013 (Resolution of 0.5 s)		
Coil 00033	Coil 00034	Coil 00035
Watchdog Enabled	Watchdog Event	Power-up Event
0 = Input Disabled		
1 = Input Enabled		
If Coil 33 (Watchdog Enabled) is set, Coil 34 (Watchdog Event) will set if the Watchdog Timeout value is exceeded.		
When set, Coil 34 can be reset by the controller when normal communications resumes.		
The Power-up Event (Coil 35) is set every time the power is applied. It can be cleared by the controller if desired.		

7. Sync

The Sync function is performed by a command sent to all devices connected on the network. When the devices receive the Sync command, all Input states are saved in the relative register. Doing this, it is possible to read the value of all inputs at the Sync command time.
 To send the Sync command, write the value 10 in the "Test" register (40001) and send to node ID 255
NOTE: The sync values are not saved in EPROM.
 When the device receives the Sync command, the actual input values in coils 13-16 are saved in register 40009 bits 4-7, channel by channel, to be read at a following time.

Coil	Register 40009 Corresponding Bit	Function
13	4	SYNC INPUT VALUE # 0
14	5	SYNC INPUT VALUE # 1
15	6	SYNC INPUT VALUE # 2
16	7	SYNC INPUT VALUE # 3

8. LED Indicator

LED	COLOR	STATE	DESCRIPTION
POWER	Green	ON	Device Powered
		OFF	Device Not Powered / Incorrect RS485 Cabling
		Fast Blink	Communication in progress/ (blink frequency depends on baud rate)
		1 Second Blink	Watch-dog Alarm Condition (See Section 6 above)

The LED is located on the front of the model.

9. Implemented Modbus Functions

Function	Code
01	Read multiple coils (0xxxx bank)
02	Read multiple coils (1xxxx bank)
03	Read multiple registers (4xxxx bank)
04	Read multiple registers (3xxxx bank)
05	Write single coil
06	Write single register
15	Write multiple coils
16	Write multiple registers
08	Diagnostic

For DIQ_512 SmartMod modules, bank 0xxxx is a mirror of bank 1xxxx, as 3xxxx is a mirror of 4xxxx i.e. the first register can be read independently as 30001 (with the function 04) or 40001 (with the function 03)

10. Installation / safety

Warning: Remove power from the OCS controller, CAN port, and any peripheral equipment connected to this local system before adding or replacing this or any module.

- All applicable codes and standards should be followed in the installation of this product.
- Shielded, twisted-pair wiring should be used for best performance.
- Shields may be terminated at the module terminal strip.
- In severe applications, shields should be tied directly to the ground block within the panel.
- Use the following wire type or equivalent: Belden 8441.

For detailed installation and a handy checklist that covers panel box layout requirements and minimum clearances, refer to the hardware manual of the controller you are using.

When found on the product, the following symbols specify:

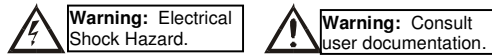

For UL installation, the device must be powered using a power supply unit classified NEC class 2 SELV.

WARNING – EXPLOSION HAZARD – Do not disconnect equipment unless power has been switched off.
AVERTISSEMENT - RISQUE D'EXPLOSION - AVANT DE DECONNECTER L'EQUIPMENT, COUPER LE COURANT.

WARNING: To avoid the risk of electric shock or burns, always connect the safety (or earth) ground before making any other connections.

WARNING: To reduce the risk of fire, electrical shock, or physical injury it is strongly recommended to fuse the voltage measurement inputs. Be sure to locate fuses as close to the source as possible.

WARNING: Replace fuse with the same type and rating to provide protection against risk of fire and shock hazards.

WARNING: In the event of repeated failure, do not replace the fuse again as a repeated failure indicates a defective condition that will not clear by replacing the fuse.

WARNING: Only qualified electrical personnel familiar with the construction and operation of this equipment and the hazards involved should install, adjust, operate, or service this equipment. Read and understand this manual and other applicable manuals in their entirety before proceeding. Failure to observe this precaution could result in severe bodily injury or loss of life.

11. Technical support

Technical Support at the following locations:

- | | |
|--|---|
| North America:
Tel: 317 916-4274
Fax: 317 639-4279
Web: http://www.hornerautomation.com
Email: techspt@heapg.com | Europe:
Tel: +353-21-4321266
Fax: +353-21-4321826
Web: http://www.horner-apg.com
Email: tech.support@horner-apg.com |
|--|---|

No part of this publication may be reproduced without the prior agreement and written permission of Horner APG, Inc. Information in this document is subject to change without notice.