

X2 Micro OCS Datasheet

Model A Built-In I/O: 12 Digital Inputs, 12 Digital Outputs, 4 Analog Inputs, 2 Analog Outputs

Model R Built-In I/O: 12 Digital Inputs, 6 Relay Outputs, 2 PWM Outputs, 4 Analog Inputs, 2 Analog Outputs

MAN1131 R21

27 NOV 2023

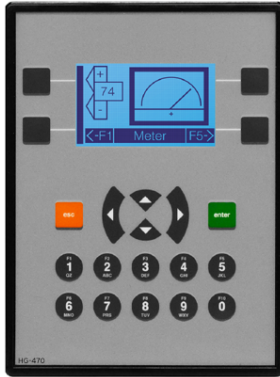

Table of Contents

Part Numbers	1
User Manual and Add-Ons	1
Battery Maintenance	1
TECHNICAL SPECIFICATIONS	2
General Specifications	2
Control and Logic	3
User Interface	4
Connectivity	4
Testing	5
CONTROLLER OVERVIEW	6
Overview of OCS	6
Power Wiring	7
DIGITAL & RELAY I/O SPECIFICATIONS	8
Digital DC Input: Models R & A	8
Model A: Digital DC Outputs, Sourcing	9
Model R: Digital DC Outputs, Sinking, Sourcing	10
Relay Outputs: Model R	11
ANALOG I/O SPECIFICATIONS	12
Analog Inputs, Models R & A	12
Analog Outputs, Models R & A	12
WIRING: INPUTS AND OUTPUTS	13
Analog Inputs Information	13
Digital Inputs	13
Positive Logic vs. Negative Logic	13
Inserting and Removing Connectors	14
Built-In I/O: Models R & A	14
J1 & J2 WIRING	15
J3 WIRING	19
COMMUNICATIONS	20
Serial Communication	20
Ethernet	20
CAN Communications	21
Discrete Wiring	21
DIMENSIONS & INSTALLATION	22
X2 Dimensions	22
Installation Procedure	23
SAFETY & MAINTENANCE	24
Warnings	24
FCC Compliance	24
Technical Support	24
Precautions	25

Part Numbers

Model R: Relay & Solid State Outputs	HE-X2R
Model A: Solid State Outputs	HE-X2A

User Manual and Add-Ons

Find the documents via the [Documentation Search](#).

Part #	Description
MAN1130	HE-X2 User Manual
HE-BAT009	3V Lithium Coin Battery
HE-XCK	Programming Cables
HE-FBD001	Ferrite core for filtering out electrical noise.
HE200MJ2TRM	Adapter, RJ45 (8P8C) male to 8-position terminal strip.

Battery Maintenance

The X2 has an advanced battery system that uses a lithium coin battery. The battery powers the real time clock when power is removed, and it is needed for register data retention. Please see manual **MAN1130** via the [Documentation Search](#) for more details on battery replacement.



TECHNICAL SPECIFICATIONS

General Specifications

Primary Pwr. Range	24VDC \pm 20%
Typical power-backlight 100%	64mA @ 24V (1.53W)
Power Backlight Off	15mA @ 24V (0.36W)
Inrush Current	30A for < 1ms
Real Time Clock	Battery backed; lithium coin cell CR2450
Clock Accuracy	\pm 90 Secs/Month
Relative Humidity	5 to 95% Non-condensing
Operating Temp.	-10°C to +60°C
Storage Temp.	-20°C to +70°C
Weight	0.75 lb/ 340g
Mounting Clips	4 composite type
Housing Material	Polycarbonate, UL rated
Panel Seal	Silicone rubber
Packaging	100% recyclable paper fiber materials

Control and Logic

Control Language Support	Advanced ladder logic; Full IEC 61131-3 languages
Logic Program Size	256kB
Non-Retentive Memory	128kB
Internal Storage Memory	16Mb
Total Program Memory	2.5Mb
Logic Scan Rate	0.4ms/kB
%I (Digital Inputs)	1024
%Q (Digital Outputs)	1024
%AI (Analog Inputs)	256
%AQ (Analog Outputs)	256
%M (Retentive Bits)	1024
%T (Temporary Bits)	1024
%R (Retentive Registers)	5000
%D (Display Bits)	250
%K (Key Bit)	10
%S (Status Bits)	16

User Interface

Display	2.2" Monochrome LCD
Resolution	128 x 64 pixels
Backlight	LED
Backlight Lifetime	50,000 hrs
Backlight Control	Software controlled (ON/OFF)
User-Programmable Screens/Pages	250
No. of Objects/Screens	15
Screen Memory	256kB
Keypad	Membrane type switches w/metal dome
Tactile Feedback	Yes
Number of Keys	4 Soft keys + 16 numeric/function keys

Connectivity

Serial Ports	1 x RS-232, 1 x RS-485
RS-485 Terminations	On-board, software controlled
Mini USB	Programming Only
CAN Hardware	Non-isolated
CAN Port Connector	RJ45 (red)
CANSpeeds Support	125kb, 250kb, 500kb, 1MB/sec.
CAN Port Termination	On-board, software controlled
CAN Protocols	CsCAN
Removable Memory In	microSD, SDHC, SDXC in FAT32 format, support for 32GB max. Application Updates, Datalogging...

Testing

Shock	IEC 60068-2-27
Vibration	IEC 60068-2-6
UL Environmental Ratings	Type 1, 4X indoor use only, 12, 12k & 13
Certifications (UL/CE)	North America Europe

CONTROLLER OVERVIEW

Overview of OCS

1. Keypad
2. High Capacity microSD slot
3. RS-232/RS-485 Serial Port
4. CAN Port (Via RJ45)
5. USB Mini-B Port
6. Analog I/O
7. DC Inputs
8. DC Outputs
9. DC Power



NOTE: See "Precautions" on page 25 about USB and grounding.

Power Wiring

NOTE: The Primary Power Range is 10VDC to 30VDC.

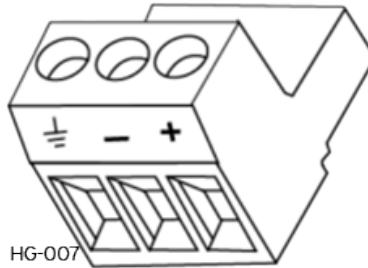

Primary Power Port Pins		
PIN	Signal	Description
1	Ground	Frame/Earth Ground
2	DC-	Input Power Supply Ground
3	DC+	Input Power Supply Voltage

Wiring Details

- Solid/Stranded Wire: 12-24 AWG (2.5-0.2mm)
- Strip length: 0.28" (7mm)
- Torque, Terminal Hold-Down Screws: 4.5 – 7 in-lbs (0.50 – 0.78 Nm)

DC- is internally connected to I/O V-, but is isolated from CAN V-. A Class 2 power supply must be used.

Power Up

1. **Optional:** Attach ferrite core with a minimum of two turns of the DC+ and DC- signals from the DC supply that is powering the controllers.



2. Connect to earth ground.
3. Apply recommended power.

DIGITAL & RELAY I/O SPECIFICATIONS

Digital DC Input: Models R & A

Inputs per Module	12 including 4 configurable HSC inputs	
Commons per Module	1	
Input Voltage Range	12VDC / 24VDC	
Absolute Max. Volt.	30VDC Max.	
Input Impedance	10k Ω	
Input Current	Positive Logic	Negative Logic
Upper Threshold	0.8mA	-1.6mA
Lower Threshold	0.3mA	-2.1mA
Max. Upper Threshold	8VDC	
Min. Lower Threshold	3VDC	
OFF to ON Response	0.1ms	
ON to OFF Response	0.1ms	
Number of Counters	4	
Maximum Counter Frequency	2.5kHz, Quadrature; 5kHz, Per Frequency; 10kHz, Totalize	
Counter Accumulator Size	32-bits each	
Counter Modes Supported	Totalizer, quadrature, pulse measurement, frequency measurement, set-point controlled outputs	

Model A: Digital DC Outputs, Sourcing

Outputs per Module	12 Including 2 Configurable PWM/HSC Outputs	
Commons per Module	2	
Type	Sourcing	
Absolute Max. Voltage	28VDC	
Output Protection	Short Circuit, Thermal, Undervoltage	
Max. Voltage Drop at Rated Current	0.25VDC	
Max Output per Point: Sourcing	0.5A @ 24VDC	
	Min	Max
OFF to ON Time (typical)	300ns	500ns + Scan Time
ON to OFF Time (typical)	300ns	475ns = Scan Time
PWM Out Maximum Frequency	65kHz	
Rise Time	150ns Max	
Fall Time	150ns Max	

Model R: Digital DC Outputs, Sinking, Sourcing

Outputs per Module	2 (PWM or HSC)	
Commons per Module	1	
Type	Sinking	
Absolute Max. Voltage	28VDC	
Output Protection	Short Circuit	
Max. Output per Point: Sinking	0.5A	
Max. Output per Point: Sourcing	2.4mA @ 24V	
Max. Voltage Drop at Rated Current	0.25VDC	
Max Outrush	650mA	
	Min	Max
OFF to ON Time (typical)	2.2 μ s	2.2 μ s + Scan Time
ON to OFF Time (typical)	13 μ s	13 μ s + Scan Time
PWM Out Maximum Frequency	65kHz	
Rise Time	2.4 μ s (typical @ 24V)	
Fall Time	7.5 μ s (typical @ 24V)	

Relay Outputs: Model R

Outputs per Module	6 Relay
Relay Contact Type	Floating
Max. Output Current & Voltage per Relay	3A @ 60VAC, resistive 3A @ 30VDC, resistive
Max. Total Output Current	5A continuous
Max. Switched Power	150W
Contact Isolation to Ground	1000VAC
Max. Voltage Drop at Rated Current	0.5V
Expected Life	No Load: 10,000,000 cycles Rated Load: 100,000 cycles
Max. Switching Rate	300 CPM at no load 20 CPM at rated load
Type	Mechanical Contact
Response Time	One update per ladder scan plus 10 ms

ANALOG I/O SPECIFICATIONS

Analog Inputs, Models R & A

Number of Channels	4
Input Ranges	0-20mA; 4-20mA
Nominal Resolution	12 Bits
Safe Input Voltage Range	-0.5V to 12V, protection up to 24V
Input Impedance (clamped @ -0.5VDC to 12VDC)	Current Mode: 100Ω
%AI Full Scale	20mA : 32,000 full scale
Max. Over Current	25mA
Max Error at 25°C (excluding Zero) Adjusting Filtering may Tighten	< 1.5% of full scale
Filtering	160 Hz Hash (noise) Filter, 1-128 Scan Digital Running Average Filter

Analog Outputs, Models R & A

Number of Channels	2
Output Ranges	4-20mA
Nominal Resolution	12 Bits
Update Rate	Once per PLC scan
Max. Error at 25°C (Excluding Zero)	< 1.5% of full scale
Maximum 20mA Load	500Ω
% AQ Full Scale	32,000
Protection	Protect against miswire up to 24VDC auto-recover

WIRING: INPUTS AND OUTPUTS

Analog Inputs Information

Raw input values for channels 1-4 are found in the registers as Integer- type data with a range from 0 – 32000. Analog inputs may be filtered digitally with the Filter Constant found in the Cscape Hardware Configuration for Analog Inputs. Valid filter values are 0-7 and act according to the following chart:

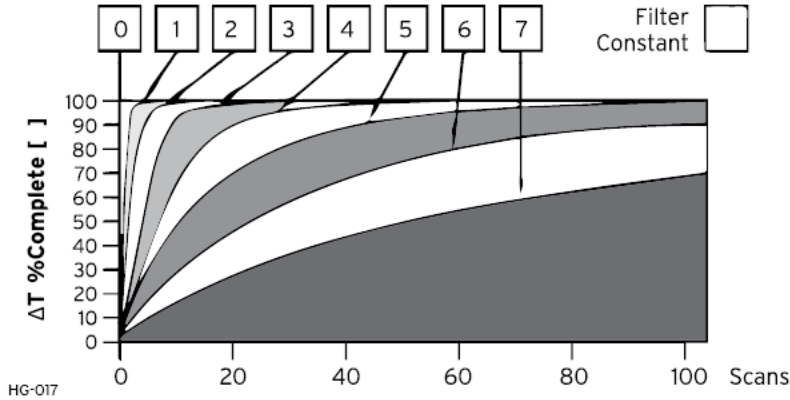

Data Values	
Input Mode:	Data Format, 12-bit INT:
0-20mA, 4-20mA	0-32000

Digital Inputs

Positive Logic vs. Negative Logic

The OCS can be wired for positive logic inputs or negative

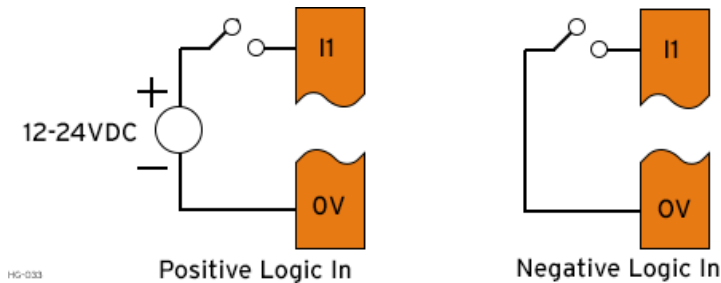

Digital inputs may be wired in either a Positive Logic or Negative Logic fashion as shown. The setting in the Cscape Hardware Configuration for the Digital Inputs must match the wiring used in order for the correct input states to be registered.

Inserting and Removing Connectors

To Insert: Using a small screwdriver, firmly press on connector on one end and then the other until connector clicks into place. Ensure connector is firmly seated.

To Remove: Use a small screwdriver on each side of connector to gently pry up the connector.

Built-In I/O: Models R & A

Fixed Address	I/O Function	Model R	Model A
%I	Digital Inputs	1-12	1-12
	Reserved	13-32	13-32
%Q	Digital Outputs	1-2	1-12
	Relay Outputs	3-8	--
	Reserved	9-16	13-16
%AI	Analog Inputs	1-4	1-4
	Reserved	5-12	5-12
%AQ	Analog Outputs	1-2	1-2
	Reserved	3-6	3-6

J1 & J2 WIRING

J1 Wiring: Model A - Digital Out

Position	Pin	Digital Model
1	Q1 (%Q1)	Dig. Out 1 (PWM)
2	Q2 (%Q2)	Dig. Out 2 (PWM)
3	Q3 (%Q3)	Dig. Out. 3
4	Q4 (%Q4)	Dig. Out. 4
5	V+	External V+
6	C	Common
7	Q5 (%Q5)	Dig Out. 5
8	Q6 (%Q8)	Dig Out. 6
9	Q7 (%Q7)	Dig Out 7
10	Q8 (%Q8)	Dig Out 8
11	Q9 (%Q9)	Dig Out 9
12	Q10 (%Q10)	Dig Out 10
13	Q11 (%Q11)	Dig Out 11
14	Q12 (%Q12)	Dig Out 12
15	V+	External V2+
16	C	Common

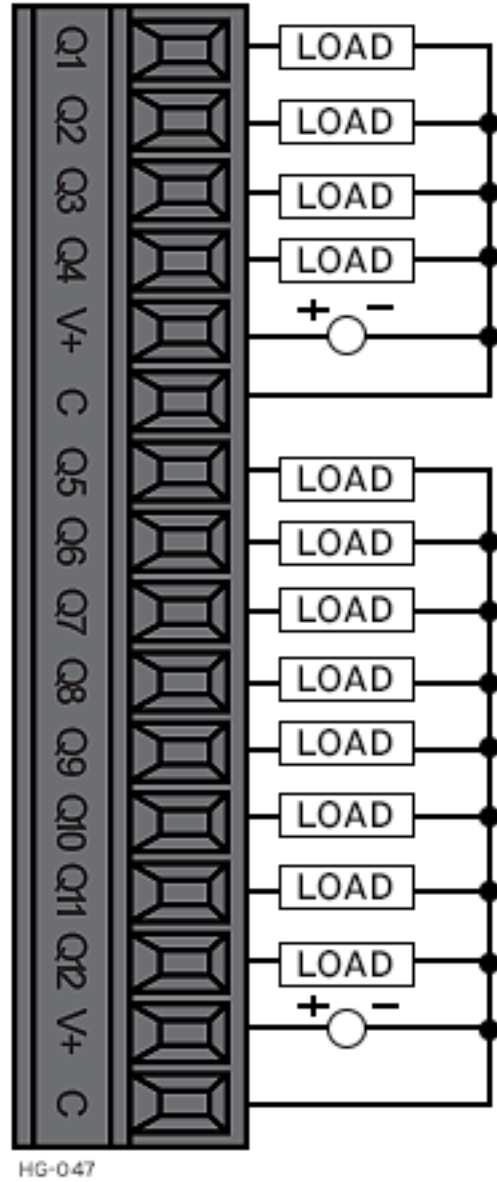

J1 Wiring: Model R - Relay/Digital Out

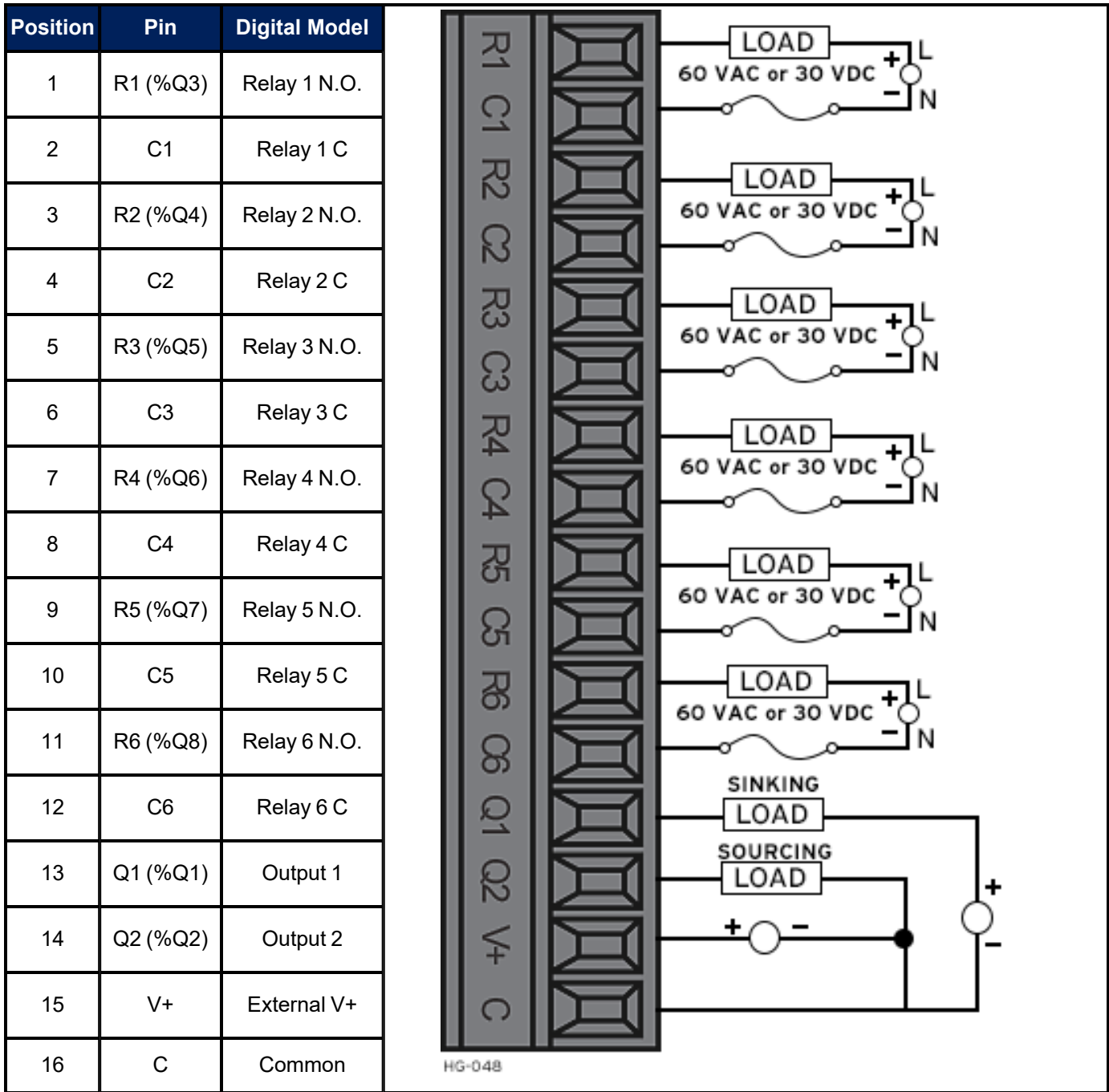

Sinking & Sourcing Wiring on Model R

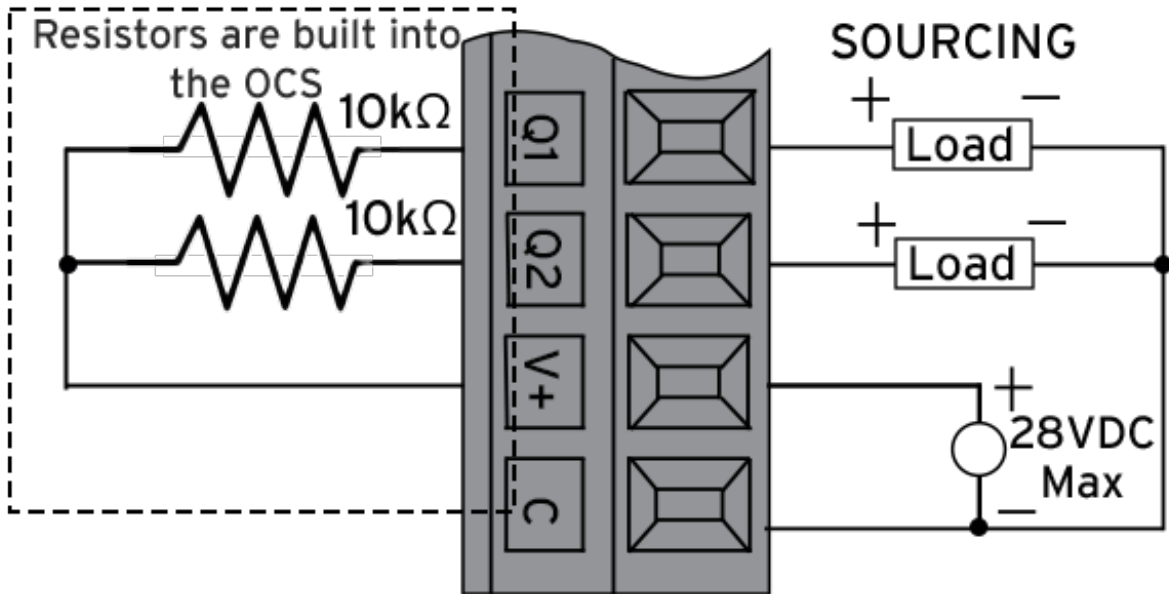

HG-206

Sourcing: 2.4mA sourcing @ 24V

11-27-2023

NOTE: Cscape offers a choice to flip the output by selecting "sourcing" as the output mode. This can come in handy when working with certain devices in this setup. It's important to note that this option doesn't alter the kind of output.

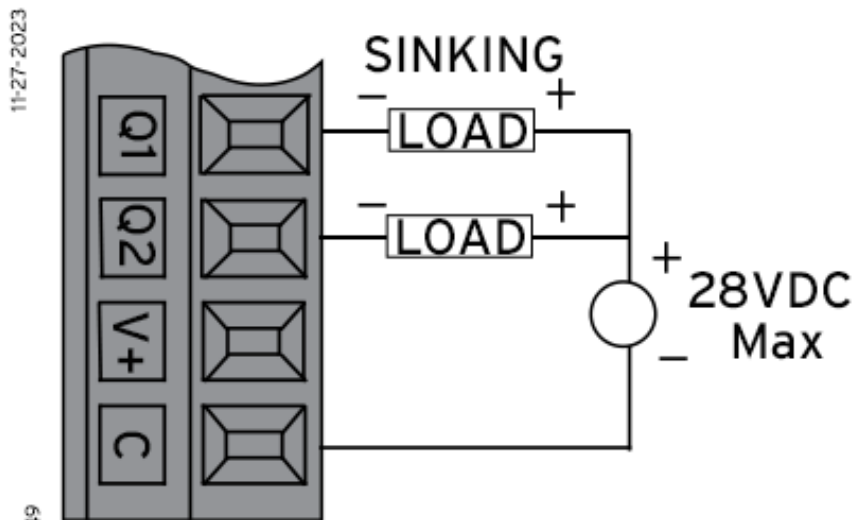

HG-049

Sinking: Outputs can sink 500mA

J2 Wiring: Models R & A - Digital Input

Position	Pin	Digital Model
1	I1 (%I1)	Dig. IN 1
2	I2 (%I2)	Dig. IN 2
3	I3 (%I3)	Dig. IN 3
4	I4 (%I4)	Dig. IN 4
5	I5 (%I5)	Dig. IN 5
6	I6 (%I6)	Dig. IN 6
7	I7 (%I7)	Dig. IN 7
8	I8 (%I8)	Dig. IN 8
9	I9 (%I9)	Dig. IN 9 (HSC)
10	I10 (%I10)	Dig. IN 10 (HSC)
11	I11 (%I11)	Dig. IN 11 (HSC)
12	I12 (%I12)	Dig. IN 12 (HSC)
13	C	Common
14	C	Common

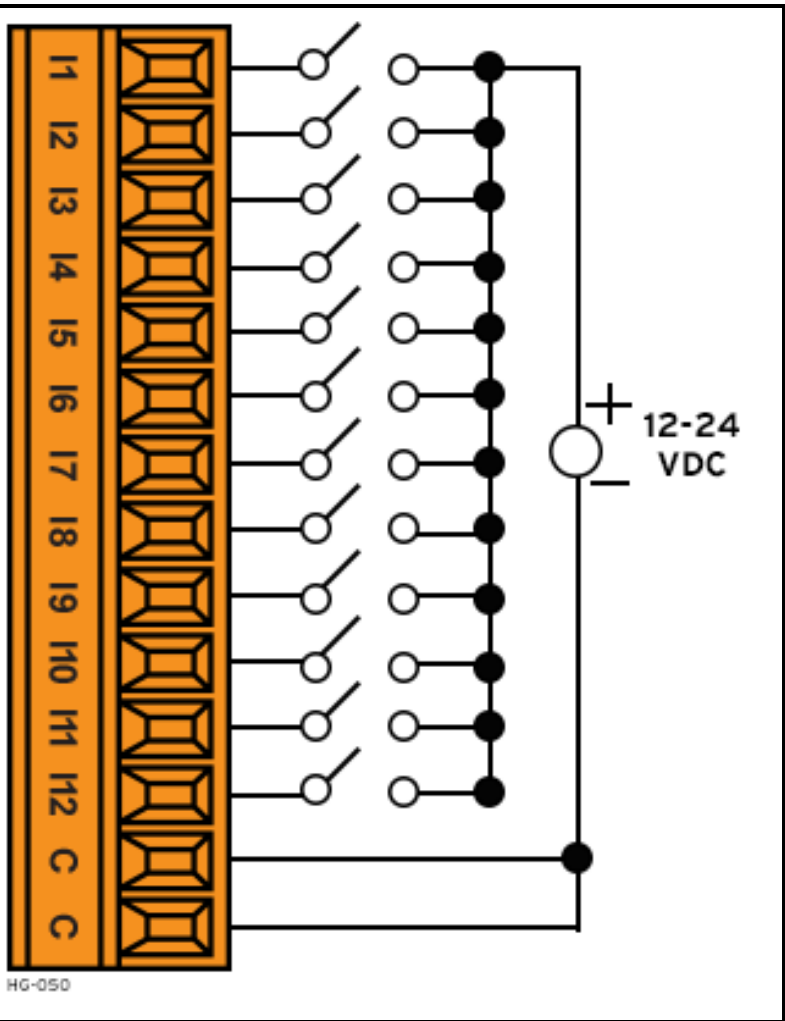

J3 WIRING

Models A & R: Analog I/O

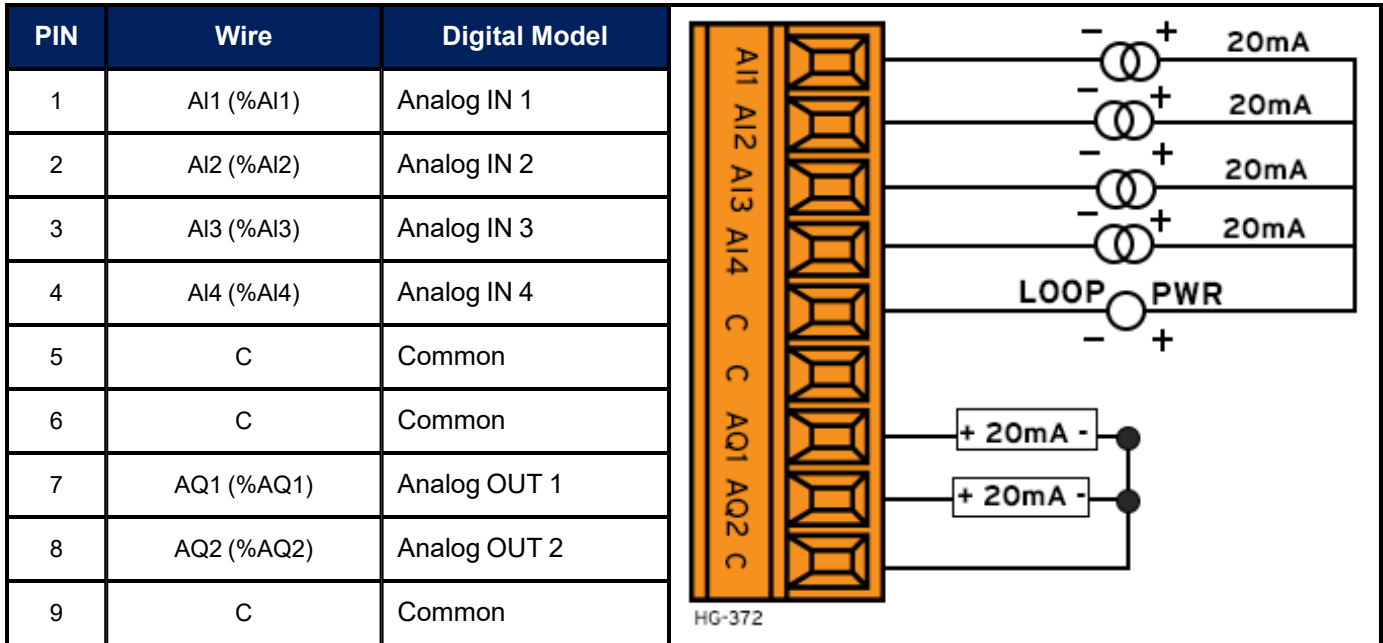

Universal Wiring Schematic

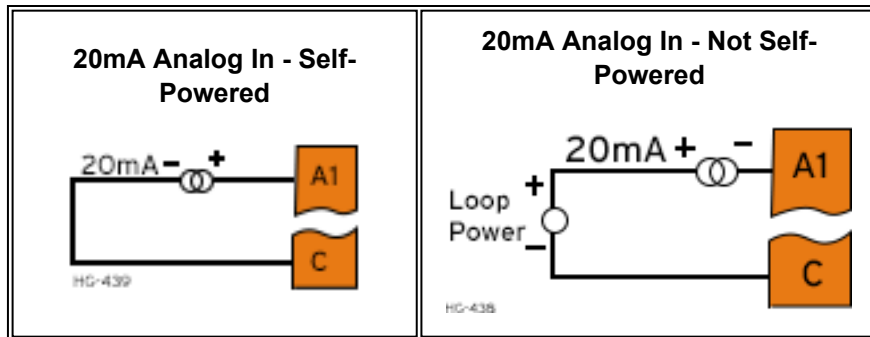

COMMUNICATIONS

Serial Communication

MJ1/2 Serial Ports

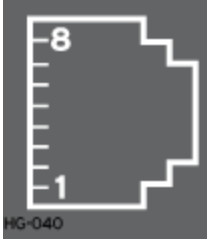
	<p>2 Serial Ports on 1 Modular jack (8p8c)</p> <p>MJ1: RS-232 w/Full Handshaking</p> <p>MJ2: RS-485 Half-Duplex - RS-485 termination and biasing via System Menu or System Register</p>	MJ1 & MJ2 PINS		
		PIN	SIGNAL	DIRECTION
		8	TXD (MJ1)	OUT
		7	RXD (MJ1)	IN
		6	0V	COMMON
		5	+5V @ 60mA	OUT
		4	RTS (MJ1)	OUT
		3	CTS (MJ1)	IN
		2	RX-/TX-/- (MJ2)	IN/OUT
		1	RX+/TX+/+ (MJ2)	IN/OUT

NOTE: Attach optional Ferrite Core (HE-FBD001) with a minimum of two turns of serial cable.

Ethernet

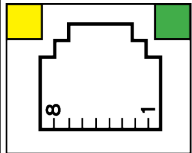
	<p>Green LED indicates link - when illuminated, data communication is available.</p> <p>Yellow LED indicates activity - when flashing, data is in transmission.</p>
---	---

CAN Communications

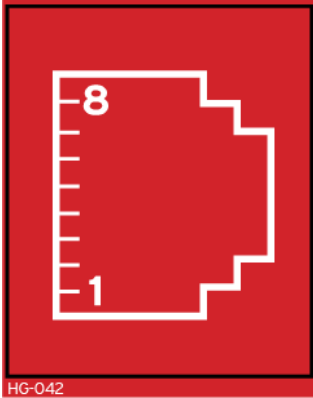
	Modular jack (8p8c)	CAN Pin Assignments	
		PIN	SIGNAL
		8	No Connection
		7	Ground (PCB Ground)
		6	[CAN] Shield (Earth Ground)
		5	No Connection
		4	No Connection
		3	Ground (PCB Ground)
		2	CAN Data Low
		1	CAN Data High

The CAN port is provided via the single 8-position modular jack labeled “CAN”. It may be used to communicate with other OCS products using Horner’s CsCAN protocol. Additionally, remote expansion I/O such as SmartRail, SmartBlock, and SmartStix may be implemented using the CsCAN protocol.

Termination for the CAN port may be enabled from the System Menu or System Register. This should only occur if this device is at either end of the CAN network. Only the two devices on either end of the CAN network should be terminated.

Discrete Wiring

For CAN or serial connections the [HE200MJ2TRM](#) accessory will provide a modular connector to wiring block adapter for installations that require discrete wiring.



HG-043

DIMENSIONS & INSTALLATION

X2 Dimensions

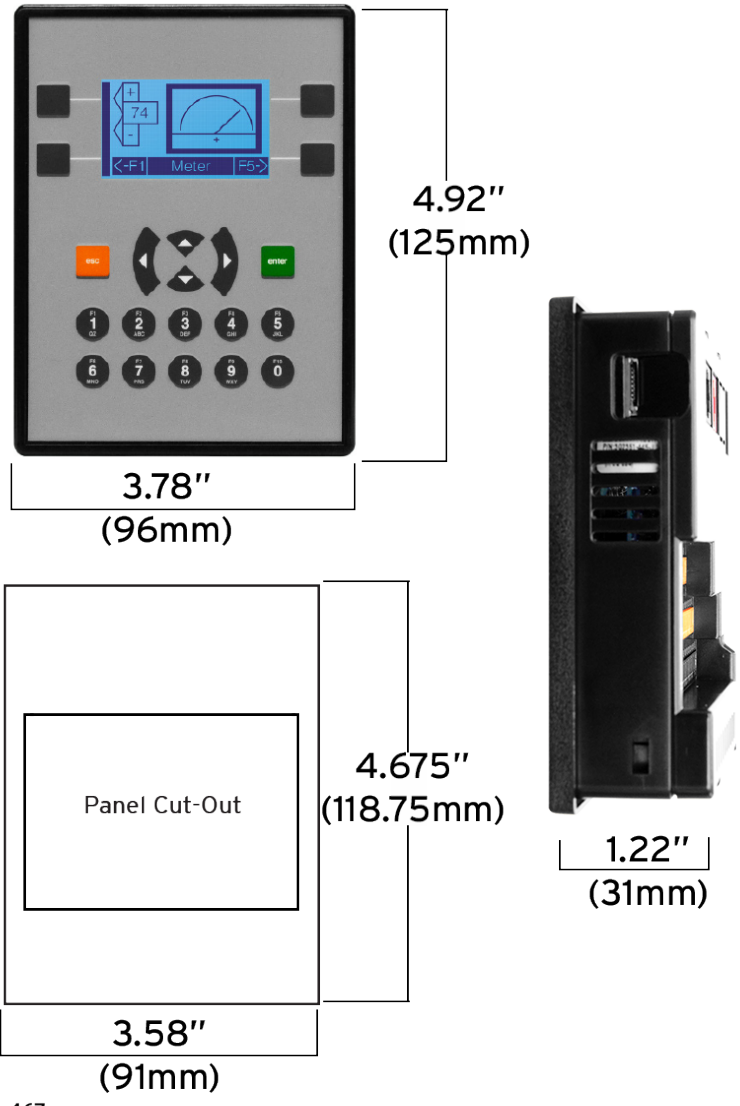

HG-467

Installation Procedure

- This equipment is panel mounted and is meant to be installed in an enclosure suitable for the environment, such that the back of the equipment is only accessible with the use of a tool.
- Requires a Class 2 power source.
- This equipment is suitable for use in Class I, Division 2, Groups A, B, C and D; Class II, Division 2 Groups F and G; and Class III Hazardous Locations or Non-Hazardous Locations only.
- The X2 utilizes a clip installation method to ensure a robust and watertight seal to the enclosure. Follow the steps below for the proper installation and operation of the unit.

Please following the steps below for the proper installation and operation of the unit.

1. Carefully locate an appropriate place to mount the X2. Be sure to leave enough room at the top of the unit for insertion and removal of the microSD™ card.
2. Carefully cut the host panel per the diagram, creating a 91mm x 118.75mm +/-0.1mm opening into which the X2 is to be installed. If the opening is too large, water may leak into the enclosure, potentially damaging the unit. If the opening is too small, the OCS may not fit through the hole without damage.
3. Remove any burrs/sharp edges and ensure the panel is not warped in the cutting process.
4. Install and tighten the four mounting clips (provided in the box) until the gasket forms a tight seal.

NOTE: For standard composite mounting clips (included with product), use a torque rating of 2-3 in-lbs (0.23-0.34Nm). For optional metal mounting clips, use a torque rating of 4-8 in-lbs (0.45-0.90 Nm).

5. Connect communications cables to the serial port, USB ports, and CAN port as required.

SAFETY & MAINTENANCE

Warnings

1. To avoid the risk of electric shock or burns, always connect the safety (or earth) ground before making any other connections.
2. To reduce the risk of fire, electrical shock, or physical injury, it is strongly recommended to fuse the voltage measurement inputs. Be sure to locate fuses as close to the source as possible.
3. Replace fuse with the same type and rating to provide protection against risk of fire and shock hazards.
4. In the event of repeated failure, do **NOT** replace the fuse again as repeated failure indicates a defective condition that will **NOT** clear by replacing the fuse.
5. Only qualified electrical personnel familiar with the construction and operation of this equipment and the hazards involved should install, adjust, operate, or service this equipment.
6. Read and understand this manual and other applicable manuals in their entirety before proceeding. Failure to observe this precaution could result in severe bodily injury or loss of life.
7. **WARNING:** Battery may explode if mistreated. Do not recharge, disassemble, or dispose of in fire.
8. **WARNING:** EXPLOSION HAZARD- Batteries must only be changed in an area known to be non-hazardous.
9. **WARNING:** Do not disconnect while circuit is live unless are is know to be non-hazardous.

FCC Compliance

This device complies with Part 15 of the FCC Rules. Operation is subject to the following two conditions:

1. This device may not cause harmful interference.
2. This device must accept any interference received, including interference that may cause undesired operation.

Technical Support

North America	Europe
1 (317) 916-4274 (877) 665-5666 www.hornerautomation.com APGUSATechSupport@heapg.com	+353 (21) 4321-266 www.hornerautomation.eu technical.support@horner-apg.com

Precautions

All applicable codes and standards need to be followed in the installation of this product. Adhere to the following safety precautions whenever any type of connection is made to the module:

1. Connect the safety (earth) ground on the power connector first before making any other connections.
2. When connecting to the electric circuits or pulse-initiating equipment, open their related breakers.
3. Do NOT make connection to live power lines.
4. Make connections to the module first; then connect to the circuit to be monitored.
5. Route power wires in a safe manner in accordance with good practice and local codes.
6. Wear proper personal protective equipment including safety glasses and insulated gloves when making connections to power circuits.
7. Ensure hands, shoes, and floor are dry before making any connection to a power line.
8. Make sure the unit is turned OFF before making connection to terminals.
9. Make sure all circuits are de-energized before making connections.
10. Before each use, inspect all cables for breaks or cracks in the insulation. Replace immediately if defective.
11. Use copper conductors in Field Wiring only, 60/75°C.
12. Use caution when connecting controllers to PCs via serial or USB. PCs, especially laptops, may use “floating power supplies” that are ungrounded. This could cause a damaging voltage potential between the laptop and controller. Ensure the controller and laptop are grounded for maximum protection. Consider using a USB isolator due to voltage potential differences as a preventative measure.