

# XL15+ Datasheet - Model 3

12 DC In, 12 DC Out, 2 – 12-bit Analog In

MAN1123\_21\_EN-XL15\_Mod3



HG-003

## Part Numbers

Global Part Number	HE-XP7E3
European Part Number	HEXT751C113

## User Manual and Add-Ons

Find the documents via the [Documentation Search](#).

Part #	Description
MAN1106	User Manual for XL15+ OCS
HE-BAT019	Rechargeable 3.6V Lithium Battery
HE-XCK	Programming Cables
HE-XDAC007	2 channel Analog Output I/O option kit, selectable 0-10V, +/-10V, 4-20mA.
HE-XDAC107	4 channel Analog Output I/O option kit, selectable 0-10V, +/-10V, 4-20mA.
HE-XKIT	Blank I/O Board
HE200MJ2TRM	Adapter, RJ45 (8P8C) male to 8-position terminal strip.
HE-FBD001	Ferrite core for filtering out electrical noise.

## Battery Maintenance

The XL15+ uses a Renata CR2032 lithium battery to run the Real-Time Clock and to maintain the retained register values. This battery is designed to maintain the clock and memory for 7-10 years. Please reference **MAN1106** providing instructions on how to replace the battery.

## Table of Contents

User Manual and Add-Ons	1
Battery Maintenance	1
<b>MODEL 3 SPECIFICATIONS</b>	<b>2</b>
General Specifications	2
Control and Logic	2
USB Webcams	2
XL15+ User Manual [MAN1106]	2
Display	3
Connectivity	4
High Speed Inputs	4
High Speed Outputs	4
Digital DC Inputs	5
Digital DC Outputs	5
Analog Inputs	6
<b>CONTROLLER OVERVIEW</b>	<b>7</b>
Port Controllers	7
Power Wiring	8
<b>WIRING: INPUTS AND OUTPUTS</b>	<b>9</b>
Digital Inputs	9
Digital Outputs	9
Analog Inputs	10
Jumper Settings for Model 3	10
Back Panel Torque Ratings	11
J1 Wiring - Digital In/Analog In	11
J2 Wiring - Digital Out	12
Wiring Details	12
Built-In I/O	12
Analog Input Tranzorb Failure	14
<b>COMMUNICATIONS</b>	<b>15</b>
Serial Communications	15
Ethernet	16
CAN Communications	17
<b>DIMENSIONS &amp; INSTALLATION</b>	<b>18</b>
Installation Procedure	19
<b>SAFETY &amp; MAINTENANCE</b>	<b>20</b>
Warnings	20
FCC Compliance	20
Precautions	20



## MODEL 3 SPECIFICATIONS

### General Specifications

Required Power (Steady State)	1978mA @ 10V (19.78W) 852mA @ 24V (20.45)
Power Backlight at 100%	800mA @ 24VDC
Power Backlight at 50%	385mA (9.6W)
Power Backlight at 0%	290mA (7W)
Inrush Current	25A for < 1ms @ 24VDC DC
Primary Power Range	18–30VDC
Clock Accuracy	+/- 20 ppm maximum at 25°C (+/- 1 min/month)
Real Time Clock	With Battery (5-10 Yrs life, Replaceable)
Relative Humidity	5 to 95% non-condensing
Operating Air Temperature	-10°C to +60°C
Storage Temperature	-30°C to +70°C
Weight	7.63 lbs/3.46 kg (without I/O)
Certifications (UL/CE)	<a href="#">North America</a> or <a href="#">Europe</a>

### Control and Logic

Control Language Support	Advanced Ladder Logic Full IEC 1131-3 Languages
Logic Program Size & Scan Rate	2MB
Logic Scan Rate	.006ms/kB
Online Programming Changes	Supported in Advanced Ladder
Digital Inputs	2048
Digital Outputs	2048
Analog Inputs	512
Analog Outputs	512
General Purpose Registers	49,999 (words) Retentive 16,384 (bits) Retentive 16,384 (bits) Non-retentive

### USB Webcams

USB Webcams supported should support the UVC (USB Video class) protocol for the OCS to be able to display video. Most USB based video devices support this today. Special feature such as zoom and high definition are not supported by the OCS.

### XL15+ User Manual [MAN1106]

The User Manual includes extensive information on:



- Built-in I/O
- I/O Status and Calibration
- Common %S & %SR Registers
- HSC/PWM/Totalizer/Quadrature & Accumulator Registers
- Resource Limits

## Display

Display Type	15" XGA TFT (500 cd/m <sup>2</sup> typical)
Resolution	1024 x 768
Color	24-bit (16,777, 216)
Built-In Storage	4 GB
User-Program Screens	1023 max pages; 1023 objects per page
Backlight	LED - 50,000 hour life
Brightness Control	0-100% via System Register
Touchscreen	Resistive w/laminated cover, 1,000,000+ touch life

## Connectivity

3x Serial Ports	RS-232 full handshaking or RS-485 half duplex on first Modular Jack (MJ1) RS-232 or RS-485 on second Modular Jack (MJ2) RS-232 or RS-485 on third Modular Jack (MJ3) (Software Controlled RS-485 Termination/Biasing)
USB mini-B	USB 2.0 (480 Mbps) Programming & Data Access
3x USB A (500mA maximum)	USB 2.0 (480 Mbps) for USB flash drives (2TB)
2x CAN	125 kbps – 1 Mbps, Remote I/O, Peer-to-Peer Comms, Cscape (Isolated Ports)
2 x Ethernet	1 Gb (Auto-MDX), Modbus TCP C/S, HTTP, FTP, SMTP, Cscape, Ethernet IP
Remote I/O	OCS-I/O
Removable Memory	microSD, SDHC, SDXC IN FAT32 format, support for 128 GB max. Application Updates, Datalogging, more
Audio	Beeper, Mic In, Line Out

## High Speed Inputs

Number of Counters	4
Maximum Frequency	1MHz Max.
Accumulator Size	32-bits each
Modes Supported	Totalizer, quadrature, pulse measurement, frequency measurement, set-point controlled outputs

## High Speed Outputs

Modes Supported	Stepper, PWM
Output Frequency	500kHz

## Digital DC Inputs

Inputs per Module	12 including 4 configurable HSC inputs	
Commons per Module	1	
Input Voltage Range	12VDC/24VDC	
Absolute Maximum Voltage	30VDC Max.	
Input Impedance	10k $\Omega$	
Input Current	Positive Logic	Negative Logic
Upper Threshold Lower Threshold	0.8mA 0.3mA	-1.6mA -2.1mA
Maximum Upper Threshold	8VDC	
Minimum Lower Threshold	3VDC	
OFF to ON Response	1ms	
ON to OFF Response	1ms	
High Speed Counter Maximum Frequency*	1MHz Max.	

\*See I/O info below for detail regarding HSC and PWM

## Digital DC Outputs

Outputs per Module	12 Including 2 Configurable PWM Outputs
Commons per Module	1
Output Type	Sourcing/10 $\Omega$ PullDown
Absolute Maximum Voltage	28VDC Max.
Output Protection	Short Circuit
Maximum Output Current/Point	0.5A
Maximum Total Current	4A continuous
Maximum Output Supply Voltage	30VDC
Minimum Output Supply Voltage	10VDC
Maximum Voltage Drop at Rated Current	0.25VDC
Maximum. Inrush Current	650mA per Channel
Minimum Load	None
OFF to ON Response	1ms
ON to OFF Response	1ms
Output Characteristics	Current Sourcing (Positive Logic)
PWM Out	$\approx$ 5kHz
Rise Time	50 - 115 $\mu$ s
Fall Time	8 - 20 $\mu$ s

## Analog Inputs

Number of Channels	2
Input Ranges	0-10VDC, 0-20mA, 4-20mA
Safe Input Voltage Range	-0.5V to + 12V
Input Impedance (clamped @ -0.5VDC to 12VDC)	<b>Current Mode:</b> 100Ω <b>Voltage Mode:</b> 500kΩ
Nominal Resolution	12 Bits
%AI Full Scale	0V, 20mA, 100mV: 32,000 counts full scale
Maximum Over Current	35mA
Conversion Speed	Once per program logic Scan
Maximum Error at 25°C (excluding Zero) Adjusting Filtering may tighten	4-20mA 1.00% 0-20mA 1.00% 0-10VDC 1.50%
Filtering	160Hz Hash (noise) Filter, 1-128 Scan Digital Running Average Filter

## CONTROLLER OVERVIEW

### Port Controllers



HG-004

1. Virtual Function Keys Slide in from the Right Upon Touching Top Right Corner of Screen
2. Optional Built-In I/O
3. High Capacity microSD Slot
4. USB Mini-B Port
5. Dual CAN Port
6. USB A Ports (3)
7. Mic Input / Audio Output
8. Dual Ethernet LAN Port
9. Mini Display Port Video Output
10. Wide-Range DC Power
11. Dual CAN Port
12. RS232/RS485 Serial Ports (3)

**NOTE:** See Precaution #12 about USB and grounding.

## Power Wiring

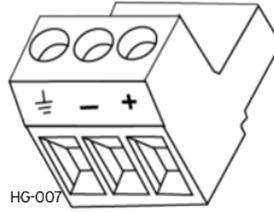

Primary Power Port Pins		
PIN	Signal	Description
1	Ground	Frame Ground
2	DC-	Input Power Supply Ground
3	DC+	Input Power Supply Voltage

### DC Input/Frame

- Solid/Stranded Wire: 12-24 awg (2.5-0.2mm)
- Strip length: 0.28" (7mm)
- Torque Rating: 4.5 – 7 in-lbs (0.50 – 0.78 N-m)

DC- is internally connected to I/O V-, but is isolated from CAN V-. A Class 2 power supply must be used.

### Power Up

1. Attach ferrite core (part number HE-FBD001) with a minimum of two turns of the DC+ and DC- signals from the DC supply that is powering the controller.



2. Connect to earth ground.
3. Apply recommended power.



## WIRING: INPUTS AND OUTPUTS

### Digital Inputs

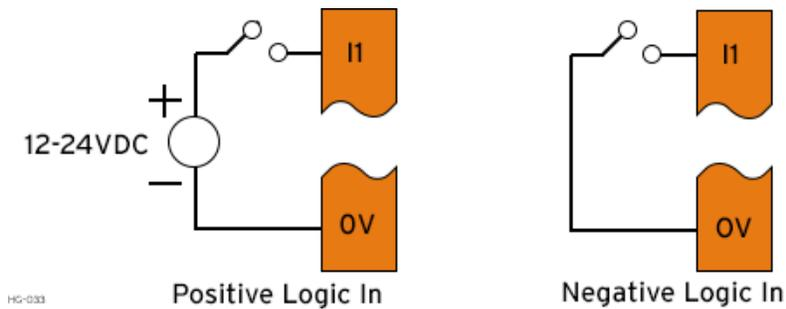

Digital inputs may be wired in either a Positive Logic or Negative Logic fashion as shown. The setting in the Cscape Hardware Configuration for the Digital Inputs must match the wiring used in order for the correct input states to be registered. No jumper settings are required for XL+. When used as a normal input and not for high speed functions, the state of the input is reflected in registers %I1 – %I12.

Digital inputs may alternately be specified for use with High Speed Counter functions, also found in the Hardware Configuration for Digital Inputs. Refer to the XL+ User Manual (MAN1106) for full details.

### Digital Outputs

Digital outputs are Positive Logic. If an output is turned on, the voltage supplied at the Vext terminal is applied to that output. When used as normal outputs, the state of the output may be controlled using the registers %Q1 - %Q12.

The first two digital outputs may alternately be specified for use as Pulse Width Modulation (PWM) or Stepper outputs. The configuration for these functions is found in the Cscape Hardware Configuration for Digital Outputs. Refer to the XL+ User Manual (MAN1106) for full details.

## Analog Inputs

Raw input values for channels 1-4 are found in the registers as Integer- type data with a range from 0 – 32000.

Analog inputs may be filtered digitally with the Filter Constant found in the Cscape Hardware Configuration for Analog Inputs. Valid filter values are 0-7 and act according to the following chart:

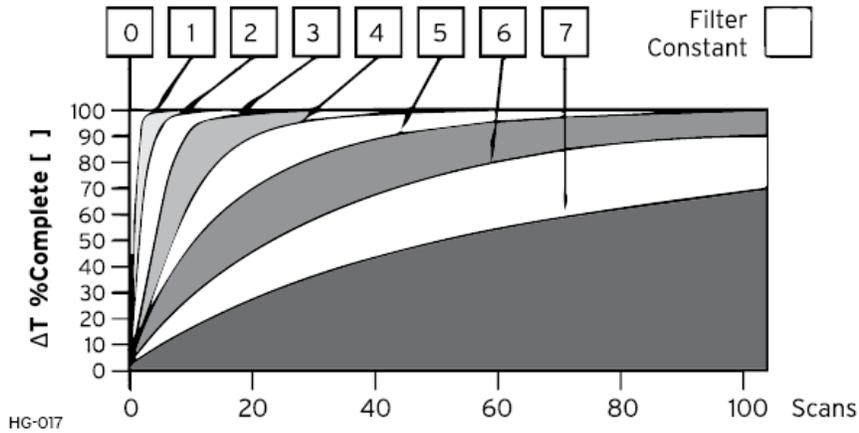

Data Values	
Input Mode:	Data Format, 12-bit INT:
0-20mA, 4-20mA	0-32000
0-10V	0-32000

## Jumper Settings for Model 3

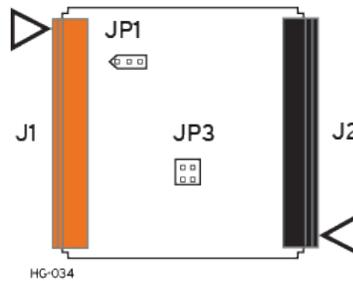

Location of I/O jumpers (JP1 & JP3) and wiring connectors (J1, J2, J3 & J4) with back cover removed.

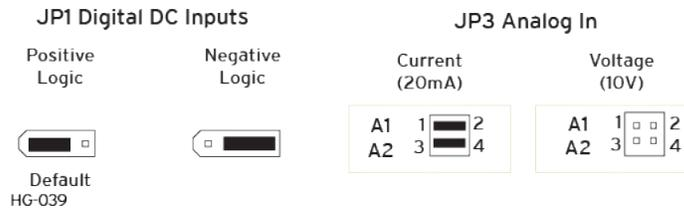

**NOTE:** The Cscape Module Configuration must match the selected I/O (JP) jumper settings.  
**Cscape Path:** Controller > Hardware Configuration > Local I/O > Config > Module > Setup > Analog In

**NOTE:** When using JP3 (A1-A2), each channel can be independently configured.

## Back Panel Torque Ratings

**XL15+:** 3.0 - 3.5 in-lbs (0.34 - 0.40 N-m)

## J1 Wiring - Digital In/Analog In

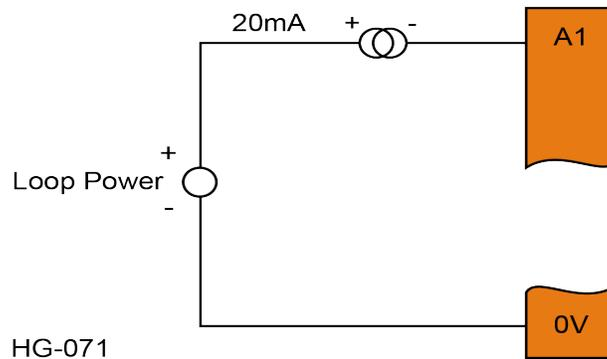
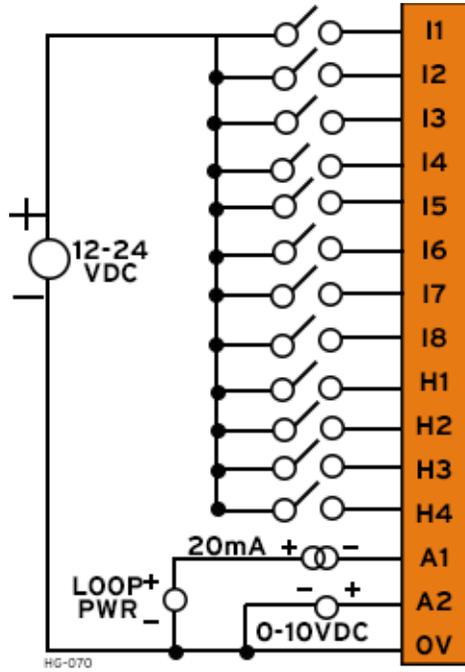

# J2 Wiring - Digital Out

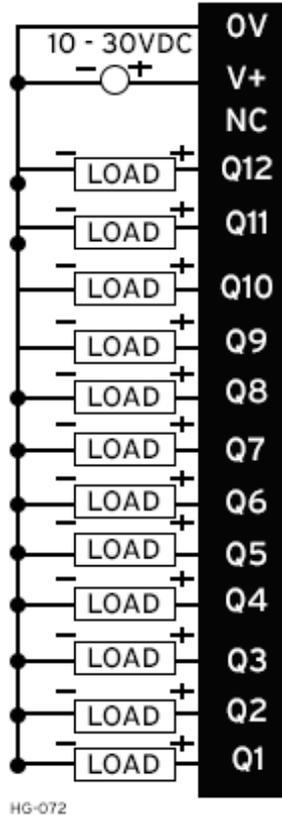

## Wiring Details

**Solid/Stranded Wire:** 12-24 awg (2.5-0.2mm<sup>2</sup>).

**Strip Length:** 0.28" (7mm).

**Torque, Terminal Hold-Down Screws:** 4.5 – 7 in-lbs (0.50 – 0.78 N-m).

## Built-In I/O

The I/O is mapped into OCS Register space, in three separate areas – Digital/Analog I/O, High-Speed Counter I/O, and High-speed Output I/O. Digital/Analog I/O location is fixed starting at 1, but the High-Speed Counter and High-Speed Output references may be mapped to any open register location. For more details refer to User Manual (MAN1106).

Digital and Analog I/O Function Registers	
Digital Inputs	%I1-12
Reserved	%I13-31
ESCP Alarm	%I32
Digital Outputs	%Q1-12
Reserved	%Q13-24
Analog Inputs	%AI1-2

<b>Reserved</b>	%AI3-12
<b>Analog Outputs</b>	n/a
<b>Reserved</b>	%AQ1-8

## Analog Input Tranzorb Failure

A common cause of Analog Input Tranzorb Failure on Analog Inputs Model 2, 3, 4 & 5: If a 4- 20mA circuit is initially wired with loop power, but without a load, the analog input could see 24VDC. This is higher than the rating of the tranzorb. This can be solved by NOT connecting loop power prior to load connection, or by installing a low-cost PTC in series between the load and analog input.

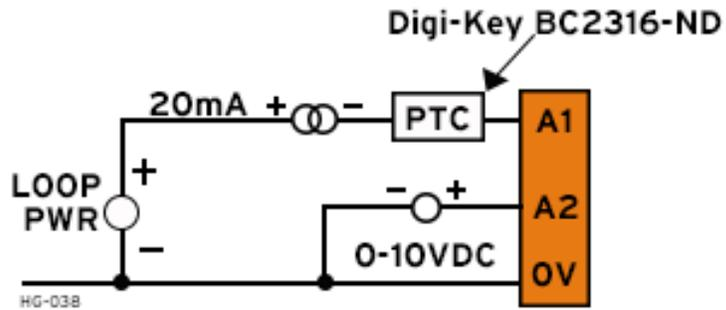

# COMMUNICATIONS

## Serial Communications

### MJ1 Serial Ports

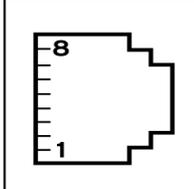
 <p>HG-008</p>	<p><b>MJ1:</b> RS-232 w/full handshaking or RS-485 half-duplex via software switch RS-485 termination and biasing via software</p>
---	--

MJ1 PINS		
PIN	SIGNAL	DIRECTION
8	TXD	OUT
7	RXD	IN
6	0V	GROUND
5	+5V @ 60mA	OUT
4	RTS	OUT
3	CTS	IN
2	RX-/TX-	IN/OUT
1	RX+/TX+	IN/OUT

### MJ2/3 Serial Ports

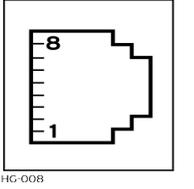
 <p>HG-008</p>	<p><b>MJ2/3:</b> RS-232 or RS-485 half or full-duplex, software selectable RS-485 termination and biasing, software selectable</p>
---	--

MJ2/3 PINS		
PIN	SIGNAL	DIRECTION
8	TXD RS232	OUT
7	RXD RS232	IN
6	0V	GROUND
5	+5V @ 60mA	OUT
4	TX- RS485	OUT
3	TX+ RS485	OUT
2	RX- RS485	IN
1	RX+ RS485-	IN

**NOTE:** Attach optional [ferrite core](#) with a minimum of two turns of serial cable. See website for more details.  
 [Part #: HE-FBD001]

### Ethernet

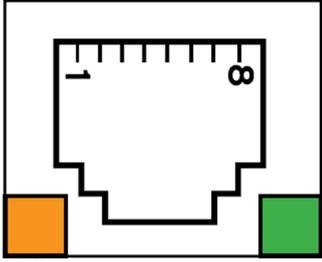
	<p><b>Green LED indicates link</b> - when illuminated, data communication is available.</p> <p><b>Orange LED indicates activity</b> - when flashing, data is in transmission.</p>
--	---



## CAN Communications

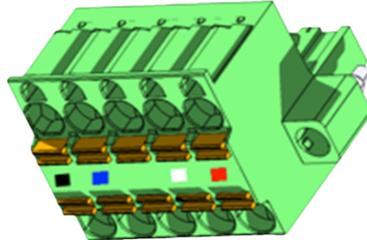

HG-001

CAN Pin Assignments		
PIN	SIGNAL	DESCRIPTION
1	V-	CAN Ground – Black
2	CN_L	CAN Data Low – Blue
3	SHLD	Shield Ground – None
4	CN_H	CAN Data High – White
5	V+ (NC)	No Connect – Red

- **Solid/Stranded Wire:** 12-24 awg (2.5-0.2mm).
- **Strip Length:** 0.28" (7mm).
- Locking spring-clamp, two-terminators per conductor.
- **Torque, Terminal Hold-Down Screws:** 4.5 – 7 in-lbs (0.50 – 0.78 N-m).

V+ pin is not internally connected, the SHLD pin is connected to Earth ground via a 1MΩ resistor and 10 nF capacitor.

# DIMENSIONS & INSTALLATION

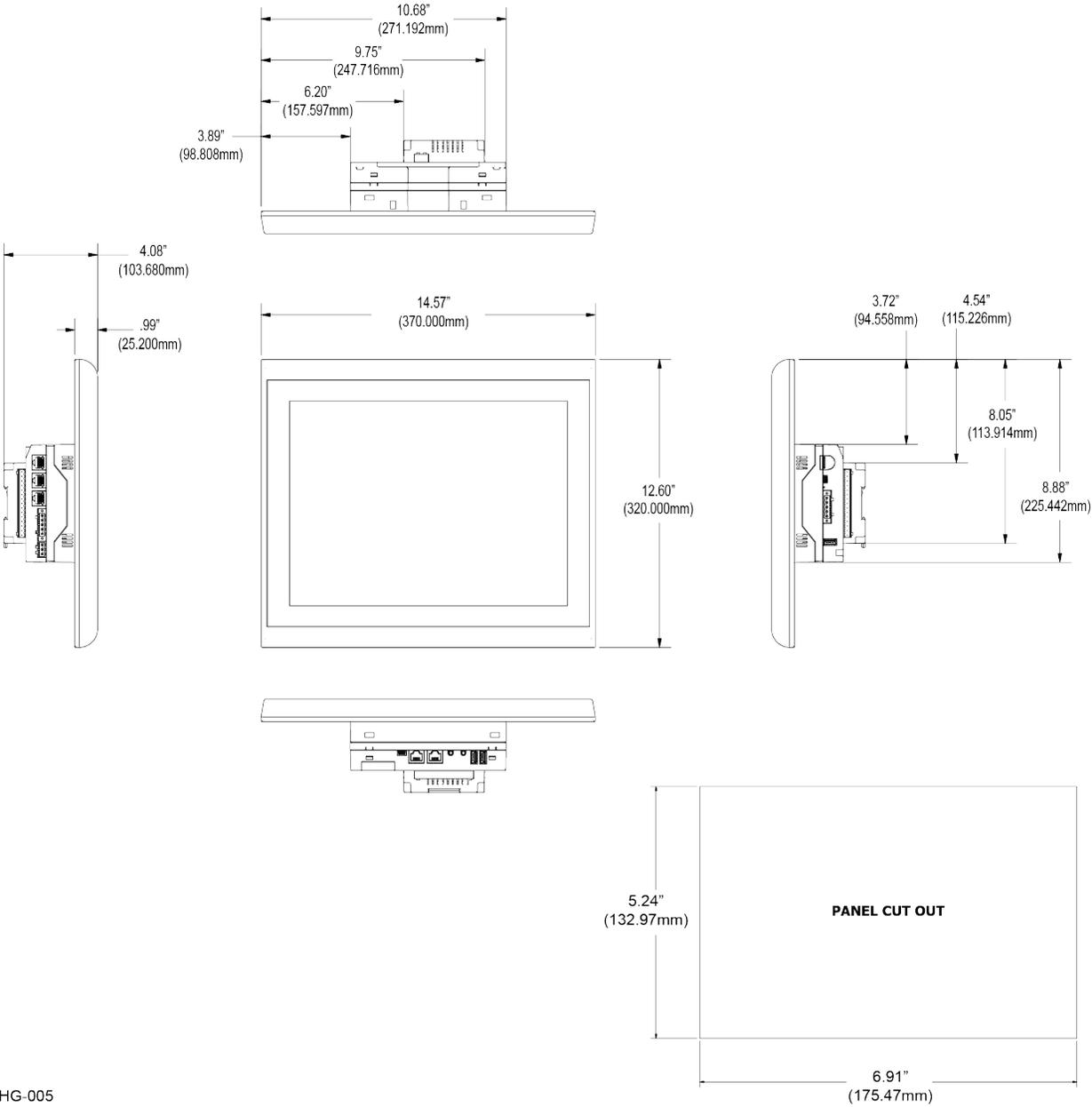

HG-005

**NOTE:** For mounting template, please refer to MAN1124.

## Installation Procedure

The XL15+ is a panel mounted device and is meant to be an enclosure suitable for the equipment, such that the equipment is only accessible with the use of a tool. The XL15+ is suitable for use in Class I, Division II, Groups F and G, and Class III Hazardous Locations or non-hazardous locations only.

The XL15+ allows unique installation options that simplify installation for systems that may not need robust vibration or water resistance.

If the system does not experience shock or vibration and will not be exposed to weather or wash down conditions the unit can be installed by cutting the rectangular opening and installing the four supplied clips.

For systems that may experience shock or vibration or are installed outdoors or in wash down environments, the rectangular cut and clips are used and perimeter holes must be drilled in the panel. The supplied studs are then inserted into the perimeter of the controller and supplied nuts will secure the perimeter of the unit to the panel.

Please reference the XL15+ Quick Reference Guide (MAN1124) for Mounting Template.

1. Remove all connectors from the XL15+ OCS unit.
2. Carefully locate an appropriate place to mount the XL+. Be sure to leave enough room at the top of the unit for insertion and removal of the microSD card. Also leave enough room at the bottom for the insertion and removal of USB FLASH drives and wiring
3. Carefully cut the host panel per the diagram, with a tolerance of +/- 0.5mm. Remove any burrs/sharp edges and ensure the panel is not warped in the cutting process.
  - If the opening is too large, water may leak into the enclosure, potentially damaging the OCS.
  - If the opening is too small, the OCS may not fit through the hole without damage.
4. Make sure both inner and outer gaskets are installed on the XL15+ OCS and are free from dust and debris. Check that the corners of the gasket are secure. Insert the OCS through the panel cutout (from the front). The gasket needs to be between the host panel and the OCS.
5. The two (2) spring clips will latch the unit in the panel.
6. Insert each of the four (4) mounting clips into the slots in the XL15+ OCS case. One clip should be installed on each corner. Lightly tighten each screw so the clip is held in place.
7. Tighten the screws on the clips such that the gasket is compressed against the panel. Recommended torque is 7-10 in-lbs (0.79-1.13 Nm). If the perimeter studs are needed, it is recommended to use a thread locker (similar to 242 Blue Loctite). Use supplied lock washers and nut.

**NOTE:** Recommended torque is 3-4 in-lbs (0.34- 0.45 Nm).

8. Reinstall the I/O Removable Terminal Blocks.  
Connect communications cables to the serial port, USB ports, Ethernet port, and CAN port as required.

## SAFETY & MAINTENANCE

### Warnings

1. To avoid the risk of electric shock or burns, always connect the safety (or earth) ground before making any other connections.
2. To reduce the risk of fire, electrical shock, or physical injury, it is strongly recommended to fuse the voltage measurement inputs. Be sure to locate fuses as close to the source as possible.
3. Replace fuse with the same type and rating to provide protection against risk of fire and shock hazards.
4. In the event of repeated failure, do **NOT** replace the fuse again as repeated failure indicates a defective condition that will **NOT** clear by replacing the fuse.
5. Only qualified electrical personnel familiar with the construction and operation of this equipment and the hazards involved should install, adjust, operate, or service this equipment.
6. Read and understand this manual and other applicable manuals in their entirety before proceeding. Failure to observe this precaution could result in severe bodily injury or loss of life.
7. **WARNING:** Battery may explode if mistreated. Do not recharge, disassemble, or dispose of in fire.
8. **WARNING:** EXPLOSION HAZARD- Batteries must only be changed in an area known to be non-hazardous.
9. **WARNING:** Do not disconnect while circuit is live unless are is know to be non-hazardous.

### FCC Compliance

This device complies with Part 15 of the FCC Rules. Operation is subject to the following two conditions:

1. This device may not cause harmful interference.
2. This device must accept any interference received, including interference that may cause undesired operation.

### Precautions

All applicable codes and standards need to be followed in the installation of this product. Adhere to the following safety precautions whenever any type of connection is made to the module:

1. Connect the safety (earth) ground on the power connector first before making any other connections.
2. When connecting to the electric circuits or pulse-initiating equipment, open their related breakers.
3. Do NOT make connection to live power lines.
4. Make connections to the module first; then connect to the circuit to be monitored.
5. Route power wires in a safe manner in accordance with good practice and local codes.
6. Wear proper personal protective equipment including safety glasses and insulated gloves when making connections to power circuits.
7. Ensure hands, shoes, and floor are dry before making any connection to a power line.
8. Make sure the unit is turned OFF before making connections to terminals.
9. Make sure all circuits are de-energized before making connections.
10. Before each use, inspect all cables for breaks or cracks in the insulation. Replace immediately if defective.
11. Use copper conductors in field wiring only, 60/75°C.



- 12. Use caution when connecting controllers to PCs via serial or USB. PCs, especially laptops, may use “floating power supplies” that are ungrounded. This could cause a damaging voltage potential between the laptop and controller. Ensure the controller and laptop are grounded for maximum protection. Consider using a USB isolator due to voltage potential differences as a preventative measure.

## Technical Support

North America	Europe
1 (317) 916-4274 1 (877) 665-5666 <a href="http://www.hornerautomation.com">www.hornerautomation.com</a> <a href="mailto:APGUSATechSupport@heapg.com">APGUSATechSupport@heapg.com</a>	+353 (21) 4321-266 <a href="http://www.hornerautomation.eu">www.hornerautomation.eu</a> <a href="mailto:technical.support@horner-apg.com">technical.support@horner-apg.com</a>