

User Manual for EXL6 & XL6 Prime



MAN1032-22-EN_EXL6_XL6P_UM

LIMITED WARRANTY AND LIMITATION OF LIABILITY

Horner APG, LLC, ("HE-APG") warrants to the original purchaser that the EXL6/XL6 Prime OCS module manufactured by HE-APG is free from defects in material and workmanship under normal use and service. The obligation of HE-APG under this warranty shall be limited to the repair or exchange of any part or parts which may prove defective under normal use and service within two (2) years from the date of manufacture or eighteen (18) months from the date of installation by the original purchaser whichever occurs first, such defect to be disclosed to the satisfaction of HE-APG after examination by HE-APG of the allegedly defective part or parts. THIS WARRANTY IS EXPRESSLY IN LIEU OF ALL OTHER WARRANTIES EXPRESSED OR IMPLIED INCLUDING THE WARRANTIES OF MERCHANTABILITY AND FITNESS FOR USE AND OF ALL OTHER OBLIGATIONS OR LIABILITIES AND HE-APG NEITHER ASSUMES, NOR AUTHORIZES ANY OTHER PERSON TO ASSUME FOR HE-APG, ANY OTHER LIABILITY IN CONNECTION WITH THE SALE OF THIS EXL6/XL6 PRIME OCS MODULE. THIS WARRANTY SHALL NOT APPLY TO THIS EXL6/XL6 PRIME OCS MODULE OR ANY PART THEREOF WHICH HAS BEEN SUBJECT TO ACCIDENT, NEGLIGENCE, ALTERATION, ABUSE, OR MISUSE. HE-APG MAKES NO WARRANTY WHATSOEVER IN RESPECT TO ACCESSORIES OR PARTS NOT SUPPLIED BY HE-APG. THE TERM "ORIGINAL PURCHASER", AS USED IN THIS WARRANTY, SHALL BE DEEMED TO MEAN THAT PERSON FOR WHOM THE EXL6/XL6 PRIME OCS MODULE IS ORIGINALLY INSTALLED. THIS WARRANTY SHALL APPLY ONLY WITHIN THE BOUNDARIES OF THE CONTINENTAL UNITED STATES.

In no event, whether as a result of breach of contract, warranty, tort (including negligence) or otherwise, shall HE-APG or its suppliers be liable of any special, consequential, incidental or penal damages including, but not limited to, loss of profit or revenues, loss of use of the products or any associated equipment, damage to associated equipment, cost of capital, cost of substitute products, facilities, services or replacement power, down time costs, or claims of original purchaser's customers for such damages.

To obtain warranty service, return the product to your distributor with a description of the problem, proof of purchase, postpaid, insured and in a suitable package.

ABOUT PROGRAMMING EXAMPLES

Any example programs and program segments in this manual or provided on accompanying media are included solely for illustrative purposes. Due to the many variables and requirements associated with any particular installation, Horner APG cannot assume responsibility or liability for actual use based on the examples and diagrams. It is the sole responsibility of the system designer utilizing the EXL6/XL6 Prime OCS module to appropriately design the end system, to appropriately integrate the EXL6/XL6 Prime OCS module and to make safety provisions for the end equipment as is usual and customary in industrial applications as defined in any codes or standards which apply.

NOTE: The programming examples shown in this manual are for illustrative purposes only. Proper machine operation is the sole responsibility of the system integrator.

PREFACE

This manual explains how to use the EXL6/XL Prime OCS.

Copyright (C) 2013 Horner APG, LLC, 59 South State Avenue, Indianapolis, Indiana 46201. All rights reserved. No part of this publication may be reproduced, transmitted, transcribed, stored in a retrieval system, or translated into any language or computer language, in any form by any means, electronic, mechanical, magnetic, optical, chemical, manual or otherwise, without the prior agreement and written permission of Horner APG, Inc.

All software described in this document or media is also copyrighted material subject to the terms and conditions of the Horner Software License Agreement.

Information in this document is subject to change without notice and does not represent a commitment on the part of Horner APG.

Cscape, SmartStack, SmartStix, SmartRail, and CsCAN are trademarks of Horner APG. Ethernet is a trademark of Xerox Corporation®.

microSD® and CompactFlash are registered trademarks of SanDisk Corporation®.

Published with Madcap Flare®.

North America

Tel: (+) (317) 916-4274

Fax: (+) (317) 639-4279

Web: <http://www.hornerautomation.com>

Email: techspt@heapg.com

Europe

Tel: (+) 353-21-4321-266

Fax: (+) 353-21-4321-826

Web: <http://hornerautomation.eu>

Email: technical.support@hornerapg.com

Table of Contents

Safety and Compliance	9
Warnings	9
FCC Compliance	9
Safety Precautions	10
Intro to the EXL6 & XL6 Prime	12
Visual Overview	12
Where to find more information for the EXL6 & XL6 Prime	13
Connectivity to the EXL6 & XL6 Prime	13
Features of EXL6/XL6 Prime OCS	14
Mechanical Installation	16
Mounting Requirements	16
Mounting Orientation	17
Dimensions	18
Installation Procedure	19
Factors Affecting Panel Layout Design and Clearances	19
Electrical Installation	22
Ground Specifications	22
How to Test for Good Ground	22
Primary Power Port	23
System Settings	25
OCS LED Indicator Lights	25
System Menu – Navigation and Editing	26
System Menu Map	27
Set Networks	28
View Status & Diags	29
View Battery Status, I/O Slots & Protocols	31
Set Fkeys Mode, Serial Ports, Ethernet, Time/Date, Beeper & Screen	34
Removable Media	40
Fail – Safe System	41
Clone Unit	44
WebMI License Details	47
Touch Screen Calibration	48
System Register Tables	50
Register Definitions	50
%S Registers	51
%SR Registers	52
I/O Register Map for EXL6 & XL6 Prime	59
PWM Function Registers Map	59
HSC Functions Registers Map	60
EXL6 & XL6 Prime Resource Limits	60
Cscape Configuration	62
Cscape Status Bar	62
Establishing Communications	63
Communicating via MJ1 Serial Port	68
Communicating via On Board Ethernet Port	69
Cscape Configuration	71
General I/O Configuration	73
Built-in Digital and Analog I/O Overview	73
Removing the Back Cover	74

Digital / HSC Input Configuration	75
Digital / PWM Output Configuration	79
Solid State Digital Outputs	79
Relay Outputs	80
Digital Output Configuration	81
Analog Inputs	84
Analog Outputs	93
High Speed I/O (HSC / PWM)	95
Overview	95
High Speed I/O Glossary	96
High Speed Counter (HSC) Functions	97
Frequency	97
Totalize	97
Pulse Width Measurement	99
Period Measurement	100
Quadrature	101
HSC Functions	102
Status Bits	103
HSC Functions Register Maps	104
HSC Functions Register Map for 2 HSC Configuration	104
HSC Functions Register Map for 4 HSC Configuration	106
High Speed Output Functions	108
Stepper Function	110
High Speed Output Functions Register Map	111
PWM Examples	112
STP Examples	113
HSC I/O Filtering	114
Serial Communications	117
Port Descriptions	117
Wiring	117
Dip Switches	118
RS485 Termination	118
RS485 Biasing	118
Cscape Programming via Serial Port	119
Ladder-Controlled Serial Communication	119
Configuration via Mini-B USB	119
CAN Communications	121
Port Description	121
CAN1 Port Wiring	121
Cscape Programming via CAN	122
Ladder-Controlled CAN Communication	122
Using CAN for I/O Expansion (Network I/O)	122
Ethernet Communications	124
Ethernet Module Protocols and Features	124
Ethernet Module Specifications	125
Ethernet Module Configuration	125
Ethernet Configuration – IP Parameters	128
Ethernet Module Protocol Configuration	128
Protocol Configuration	130
Overview	130
Protocol Device Driver Selection	131
Network Configuration	132
Device List and Device Configuration	134

Scan List	136
User Interface	141
Screen Specifications	141
Displaying and Entering Data	142
Alpha-Numeric Keypad	143
Screen Navigation	144
Ladder-Based Screen Navigation	145
Beeper Acknowledgement	145
Touch (Slip) Sensitivity	146
Alarms	146
Removable Media	148
Screen Saver	149
Screen Brightness	149
Touch Screen Pressure	150
Video Object	152
Video Object Overview	152
Opening Video Object in Cscape	153
Video Properties Configuration	155
Video Object Performance	157
Web Cameras	157
Removable Media	159
microSD Cards	159
Using the Removable Media Manager	160
Log Data	160
View and Capture Screens	161
Removable Media Object	161
Function Blocks in Cscape	162
Filenames	163
System Registers used with RM	163
Clone Unit	165
Make Clone	165
Load Clone	167
Fail-Safe System	169
For the XL & X Series	169
For the XL Prime Series	169
Fail-Safe System Overview	170
Settings	170
Backup / Restore Data	171
Clear Backup Data	172
AutoLoad	174
AutoRun	176
Modbus Communications	178
Modbus Slave Overview	178
Modbus Master Overview	179
Modbus Addressing Table	180
EXL6 Rechargeable Battery	182
Storing Register Contents	182
Battery Life	182
Lithium Battery Safety	182
OCS Battery Charging Cycle	183
Battery Charging Status	184
Battery Status in System Registers	185
Safety & the Rechargeable Backup Battery	185

Steps to Replace the Rechargeable Battery	186
Prime OCS Battery	188
Safety	188
Replacing the Battery	189
Firmware Updates	191
Check for Current Firmware Revision	191
Firmware Update Details	192
Download Firmware	192
Firmware Update Steps	193
Troubleshooting	195
Connecting to the OCS	195
Serial Port – MJ1 Programming	195
USB Port - Mini B Programming	196
ETN Port Programming	196
Local Controller and Local I/O	196
Local I/O Troubleshooting Checklist	196
CsCAN Network	197
CsCAN Network Troubleshooting Checklist	197
USB Interfaces	197
Basic Troubleshooting	198
Technical Support Contacts	198
INDEX	199
Change Log	204

Safety and Compliance



Safety and Compliance

Warnings

When found on the product, the following symbols specify:



Warning: Consult user documentation.



Warning: Electrical Shock Hazard.

WARNING: EXPLOSION HAZARD – Substitution of components may impair suitability for Class I, Division 2.
WARNING: EXPLOSION HAZARD – Do not disconnect equipment unless power has been switched off or the area is known to be non-hazardous.

1. To avoid the risk of electric shock or burns, always connect the safety (or earth) ground before making any other connections.
2. To reduce the risk of fire, electrical shock, or physical injury it is strongly recommended to fuse the voltage measurement inputs. Be sure to locate fuses as close to the source as possible.
3. Replace fuse with the same type and rating to provide protection against risk of fire and shock hazards.
4. In the event of repeated failure, do not replace the fuse again as a repeated failure indicates a defective condition that will not clear by replacing the fuse.
5. Only qualified electrical personnel familiar with the construction and operation of this equipment and the hazards involved should install, adjust, operate, or service this equipment. Read and understand this manual and other applicable manuals in their entirety before proceeding. Failure to observe this precaution could result in severe bodily injury or loss of life.

NOTE: All applicable codes and standards need to be followed in the installation of this product.

NOTE: For I/O wiring (discrete), use the following wire type or equivalent: Belden 9918, 18 AWG or larger.

NOTE: See the "Electrical Installation" on page 22 for more details.

FCC Compliance

This device complies with Part 15 of the FCC Rules. Operation is subject to the following two conditions:

1. This device may not cause harmful interference.
2. This device must accept any interference received, including interference that may cause undesired operation.

Safety Precautions

Adhere to the following safety precautions whenever any type of connection is made to the module:

All applicable codes and standards need to be followed in the installation of this product. Adhere

to the following safety precautions whenever any type of connection is made to the module:

1. Connect the safety (earth) ground on the power connector first before making any other connections.
2. When connecting to the electric circuits or pulse-initiating equipment, open their related breakers.
3. Do NOT make connection to live power lines.
4. Make connections to the module first; then connect to the circuit to be monitored.
5. Route power wires in a safe manner in accordance with good practice and local codes.
6. Wear proper personal protective equipment including safety glasses and insulated gloves when making connections to power circuits.
7. Ensure hands, shoes, and floor are dry before making any connection to a power line.
8. Make sure the unit is turned OFF before making connection to terminals.
9. Make sure all circuits are de-energized before making connections.
10. Before each use, inspect all cables for breaks or cracks in the insulation. Replace immediately if defective.
11. Use copper conductors in Field Wiring only, 60/75°C.
12. Use caution when connecting controllers to PCs via serial or USB. PCs, especially laptops may use “floating power supplies” that are ungrounded. This could cause a damaging voltage potential between the laptop and controller. Ensure the controller and laptop are grounded for maximum protection. Consider using a USB isolator due to voltage potential differences as a preventative measure.

Introduction to the EXL6 & XL6 Prime



Intro to the EXL6 & XL6 Prime

Visual Overview	12
Where to find more information for the EXL6 & XL6 Prime	13
Connectivity to the EXL6 & XL6 Prime	13
Features of EXL6/XL6 Prime OCS	14

Visual Overview



1. Touchscreen
2. Function Keys
3. USB 2.0 "A": Flash Drive
4. LAN Port
5. PWR: 10-30VDC In
6. CAN Port
7. MJ3: RS-232/485
8. Dip Switches
9. MJ1/MJ2: RJ45 Serial Port
10. microSD: Data Storage
11. USB mini "B": Programming

NOTE: See Precaution #12 on page 4 about USB and grounding.

Where to find more information for the EXL6 & XL6 Prime

Datasheets - The datasheets are the first documents to refer to for key information related to specific models. (A basic datasheet is provided in the box with the unit.) Find the documents via the [Documentation Search](#) page on the Horner website.

Datasheet Manual Numbers	
EXL6 Model 0 XL6 Prime Model 0	MAN1168 MAN1326
EXL6 Model 2 XL6 Prime Model 2	MAN1169 MAN1327
EXL6 Model 3 XL6 Prime Model 3	MAN1170 MAN1328
EXL6 Model 4 XL6 Prime Model 4	MAN1171 MAN1329
EXL6 Model 5 XL6 Prime Model 5	MAN1172 MAN1330
EXL6 Model 6 XL6 Prime Model 6	MAN1173 MAN1331

Connectivity to the EXL6 & XL6 Prime

Connectivity				
CAN	I/O	USB	Serial	Ethernet
Other OCS Devices	Sensors	Flash Drive	Other OCS Devices	Cscape
SmartStix I/O	Indicators	Cscape	Drives	OPC Server
SmartBlock I/O	Alarms		PLCs	Modbus TCP Devices
SmartRail I/O	Encoders		Printers	
OPC	Pumps		SCADA	
	Relays		OPC Server	
	Solenoids		Portal	
			I/O Devices	
		SmartRail Devices		

Features of EXL6/XL6 Prime OCS

The EXL6/XL6 PRIME OCS are all-in-one industrial control devices. They combine control, user interface, I/O and networking into a single, integrated package. Unique features of the EXL6/XL6 PRIME OCS include:

- Bright, 65,536 color graphical touch sensing LCD display in all models of EXL6/XL6 PRIME.
- Display of complex graphical objects including trends, gauges, meters and animations.
- Very high-performance graphic processing.
- Advanced control capabilities including floating point, multiple auto-tuning PID loops and string handling capabilities.
- Removable media for 32GB of storage of programs, data logging or screen captures.
- CsCAN networking port for communication with remote I/O, other controllers or PCs.
- High speed USB port for communication with PCs and programming of controller.
- Configurable serial protocols for communication to drives, PLCs, or other serial peripherals.
- Full featured, built-in I/O including high resolution analog, thermocouple, RTD, high-speed counters, PWM outputs and relays (depending upon the EXL6/XL6 PRIME OCS model used).
- Advanced high speed I/O capabilities.
- Cscape programming software that allows all aspects of the EXL6/XL6 PRIME OCS to be programmed and configured from one integrated application.
- Optional communication add-on modules.
- Two on board Ethernet ports (10/100Mbps) for Cscape programming and application defined communication, with Auto MDI/MDI-X.

Mechanical Installation



Mechanical Installation

Mounting Requirements	16
Mounting Orientation	17
Dimensions	18
Installation Procedure	19
Factors Affecting Panel Layout Design and Clearances	19

NOTE: The datasheet is the first document to refer to for model-specific information related to EXL6 & XL6 Prime models such as pin-outs, jumper settings, and other key installation information. See the [Documentation Search](#) for datasheets.

The mechanical installation greatly affects the operation, safety and appearance of the system. Information is provided to mechanically install the unit such as cut-out sizes, mounting procedures, and other recommendations for the proper mechanical installation of the unit.

Mounting Requirements

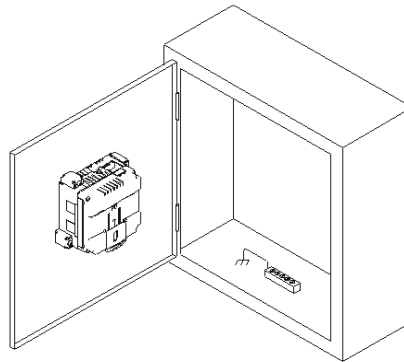

Once the panel design has been completed using the criteria and suggestions in the following sections, use the following steps to panel mount the EXL6 & XL6 Prime OCS.

1. Remove all connectors from the EXL6 & XL6 Prime OCS unit.
2. Make sure the gasket is installed on the EXL6 & XL6 Prime OCS and is free from dust and debris. Check that the corners of the gasket are secure.
3. Pass the unit through the panel.
4. Insert the each of the four (4) mounting clips into the slots in the EXL6 & XL6 Prime OCS case. One clip should be installed on each corner. Lightly tighten each screw so the clip is held in place.
5. Tighten the screws on the clips such that the gasket is compressed against the panel. Recommended torque is 4-8 in-lbs (0.45 – 0.90 N-m).

Mounting Orientation

OCS Mounting Clip

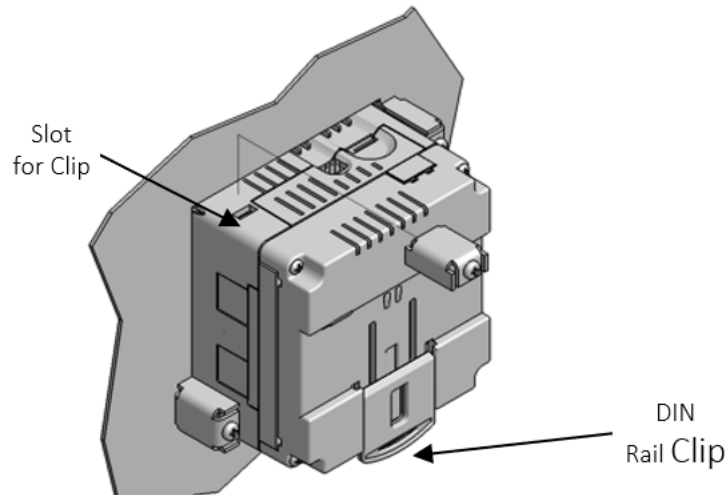

OCS Mounting Orientation

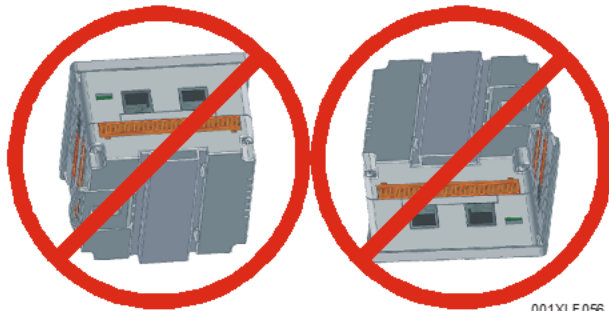
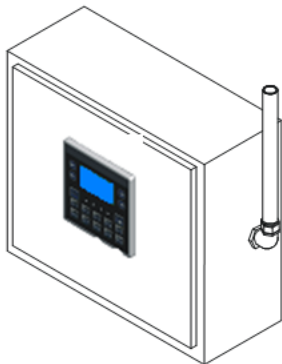

001XLE056

NOTE—For panel or DIN rail mounting: The orientation shown above provides for optimum readability of the screen and ease of use of the keypad.

CAUTION—For DIN Rail mounting: To prevent the unit from slipping off the DIN Rail, do not install the unit on its sides as shown. Be sure the DIN Rail is in the horizontal position.

Dimensions



*+1mm / -0mm cutout tolerance

Installation Procedure

- The EXL6/XL6 PRIME utilizes a clip installation method to ensure a robust and watertight seal to the enclosure. Please follow the steps below for the proper installation and operation of the unit.
 - This equipment is suitable for Class I, Division 2, Groups A, B, C and D or non-hazardous locations only.
 - Digital outputs shall be supplied from the same source as the operator control station.
 - Jumpers on connector JP1 shall not be removed or replaced while the circuit is live unless the area is known to be free of ignitable concentrations of flammable gases or vapors.
1. Carefully locate an appropriate place to mount the EXL6/XL6 PRIME. Be sure to leave enough room at the top of the unit for insertion and removal of the microSD™ card.
 2. Carefully cut the host panel per the diagram, creating a 131.9mm x 175.0mm, with a +1mm/-0mm opening into which the EXL6/XL6 PRIME may be installed. If the opening is too large, water may leak into the enclosure, potentially damaging the unit. If the opening is too small, the OCS may not fit through the hole without damage.
 3. Remove any burrs and or sharp edges and ensure the panel is not warped in the cutting process.
 4. Remove all Removable Terminals from the EXL6/XL6 PRIME. Insert the EXL6/XL6 PRIME through the panel cutout (from the front). The gasket must be between the host panel and the EXL6/XL6 PRIME.
 5. Install and tighten the four mounting clips (provided in the box) until the gasket forms a tight seal NOTE: Max torque is 0.8 to 1.13Nm, or 7 to 10 in-lbs.
 6. Reinstall the EXL6/XL6 PRIME I/O Removable Terminal Blocks. Connect communications cables to the serial port, USB ports, Ethernet port, and CAN port as required.

Factors Affecting Panel Layout Design and Clearances

WARNING: It is important to follow the requirements of the panel manufacture and to follow all applicable electrical codes and standards.

The designer of a panel layout must assess the requirements of a particular system and to consider the following design factors.

Clearance / Adequate Space

Install devices to allow sufficient clearance to open and close the panel door.

Minimum Clearance Requirements for Panel Box and Door	
Minimum Distance between base of device and sides of cabinet	2" (50.80mm)
Minimum Distance between base of device and wiring ducts	1.5" (38.10mm)
If more than one device installed in panel box (or on door): Minimum Distance between bases of each device	4" (101.60mm) between bases of each device
When door is closed: Minimum distance between device and closed door (Be sure to allow enough depth for the OCS.)	2" (50.80mm)

Grounding

Panel Box: The panel box must be properly connected to earth ground to provide a good common ground reference.

Panel Door: Tie a low impedance ground strap between the panel box and the panel door to ensure that they have the same ground reference.

WARNING: Be sure meet the ground requirements of the panel manufacturer and also meet applicable electrical codes and standards.

Temperature / Ventilation

Ensure that the panel layout design allows for adequate ventilation and maintains the specified ambient temperature range. Consider the impact on the design of the panel layout if operating at the extreme ends of the ambient temperature range. For example, if it is determined that a cooling device is required, allow adequate space and clearances for the device in the panel box or on the panel door.

Noise

Consider the impact on the panel layout design and clearance requirements if noise suppression devices are needed. Be sure to maintain an adequate distance between the OCS and noisy devices such as relays, motor starters, etc.

Shock and Vibration

The OCS has been designed to operate in typical industrial environments that may inflict some shock and vibration on the unit. For applications that may inflict excessive shock and vibration please use proper dampening techniques or relocate the OCS to a location that minimizes shock and/or vibration.

Panel Layout Design and Clearance Checklist

The following list provides highlights of panel layout design factors:

- Meets the electrical code and applicable standards for proper grounding, etc.?
- Meets the panel manufacturer's requirements for grounding, etc.?
- Is the panel box properly connected to earth ground? Is the panel door properly grounded? Has the appropriate procedure been followed to properly ground the devices in the panel box and on the panel door?
- Are minimum clearance requirements met? Can the panel door be easily opened and closed? Is there adequate space between device bases as well as the sides of the panel and wiring ducts?
- Is the panel box deep enough to accommodate the controller?
- Is there adequate ventilation? Is the ambient temperature range maintained? Are cooling or heating devices required?
- Are noise suppression devices or isolation transformers required? Is there adequate distance between the base of the controller and noisy devices such as relays or motor starters? Ensure that power and signal wires are not routed in the same conduit.
- Are there other requirements that impact the particular system, which need to be considered?

Electrical Installation



Electrical Installation

Ground Specifications	22
How to Test for Good Ground	22
Primary Power Port	23

NOTE: The datasheet is the first document to refer to for model-specific information. Refer to the [Documentation Search](#) on the Horner website.

Ground Specifications

Ideally, a ground resistance measurement from equipment to earth ground is 0Ω. In reality it typically is higher. The US National Electrical Code (NEC) states the resistance to ground shall not exceed 25Ω. Horner Automation recommends less than 15Ω resistance from the equipment to ground. Resistance greater than 25Ω can cause undesirable or harmful interference to the device.

Grounding Definition - The term Ground is defined as a conductive connection between a circuit or piece of equipment and the earth. Grounds are fundamentally used to protect an application from harmful interference causing either physical damage such as by lightning or voltage transients or from circuit disruption often caused by radio frequency interference (RFI).

How to Test for Good Ground

In order to test ground resistance, a Ground Resistance Tester must be used. A typical Ground Resistance Meter Kit contains a meter, two or three wire leads, and two ground rods. Instructions are supplied for either a two-point or a three-point ground test. The figure shows a two-point ground connection test.

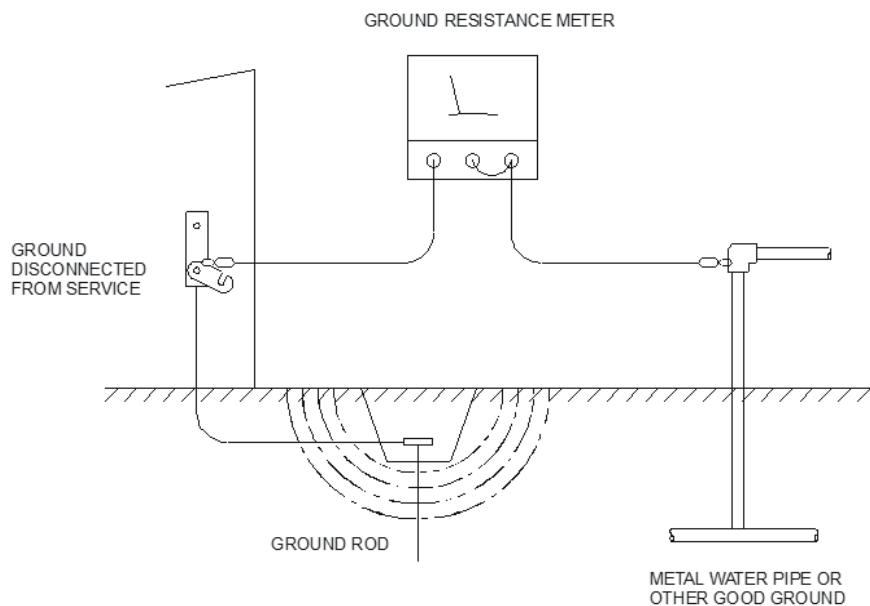

Primary Power Port

NOTE: The Primary Power Range is 10VDC to 30VDC.

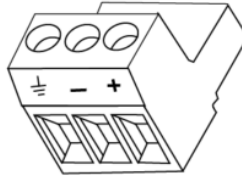

Primary Power Port Pins		
PIN	Signal	Description
1	Ground	Frame Ground
2	DC-	Input Power Supply Ground
3	DC+	Input Power Supply Voltage

DC Input / Frame

- Solid/Stranded Wire: 12-24 awg (2.5-0.2mm)
- Strip length: 0.28" (7mm)
- Torque, Terminal Hold-Down Screws: 4.5 – 7 in-lbs (0.50 – 0.78 N-m)
- DC- is internally connected to I/O V-, but is isolated from CAN V-. A Class 2 power supply must be used.

Power Up

1. **OPTION:** Attach ferrite core with a minimum of two turns of the DC+ and DC- signals from the DC supply that is powering the controllers.



2. Connect to earth ground.
3. Apply recommended power.

System Settings and Adjustments



System Settings

OCS LED Indicator Lights	25
System Menu – Navigation and Editing	26
System Menu Map	27
Set Networks	28
View Status & Diags	29
View Battery Status, I/O Slots & Protocols	31
Set Fkeys Mode, Serial Ports, Ethernet, Time/Date, Beeper & Screen	34
Removable Media	40
Fail – Safe System	41
Clone Unit	44
WebMI License Details	47
Touch Screen Calibration	48

OCS LED Indicator Lights

The EXL6/XL6 Prime has a built-in System Menu, which lets the user view System Settings and makes adjustments. To start the System Menu, press the SYSTEM key (or set %SR3 to 1), which will display the Main Menu. Then use the ↑ and ↓ (Up Arrow or Down Arrow) keys to select a Main Menu item and press Enter (Return Arrow) to display the item’s Sub-Menu.

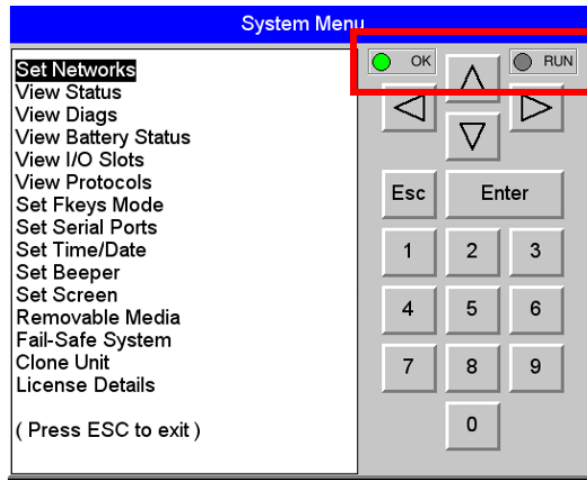

OCS LEDs	
RUN	<ul style="list-style-type: none"> ■ OFF indicates OCS is in IDLE/STOP mode. ■ Flashing indicates DO / IO mode or RUN with no ladder program. ■ ON indicates ladder code running.
OK	<ul style="list-style-type: none"> ■ OFF indicates one or more self-tests failed. ■ ON indicates all self-tests passed. ■ Flashing at 1 Hz indicates forcing is active.

System Menu – Navigation and Editing

As mentioned above, the System Menu is started by pressing the System key on the EXL6/XL6 PRIME. Next press **ESC** to exit the System Menu or use \uparrow and \downarrow to select an item and press Enter to display the item's Sub-Menu.

A Sub-Menu generally shows a list of System Settings and their values. After opening a Sub-Menu, if any of its System Settings are editable, the first System Setting that can be edited is highlighted. If desired, the \uparrow and \downarrow keys can be used to select a different System Setting to be edited.

At this point, either press ESC to exit the Sub-Menu (returning to the Main Menu) or press Enter to edit the highlighted System Setting. If **Enter** is pressed, the System Setting's value will be highlighted, indicating that it is ready to be modified.

When modifying a System Setting's value, use either the arrow keys ($\leftarrow \rightarrow \uparrow \downarrow$) or the numeric keys, or the appropriate touch screen icons to select a new value.

The arrow keys are used to edit System Settings that have just a few possible values. Each time the arrow key is pressed, a new possible value is displayed. When the desired value appears, press the **Enter** key to save it; otherwise press the **ESC** key to cancel the edit.

The numeric keys are normally used to enter numeric System Settings. In addition, to edit a single numeric digit, use the \leftarrow or \rightarrow key to select the digit and then either press a numeric key or use \downarrow or \uparrow to modify the digit. In any case, after entering the new desired value, press the **Enter** key to save it; otherwise press the **ESC** key to cancel the edit.

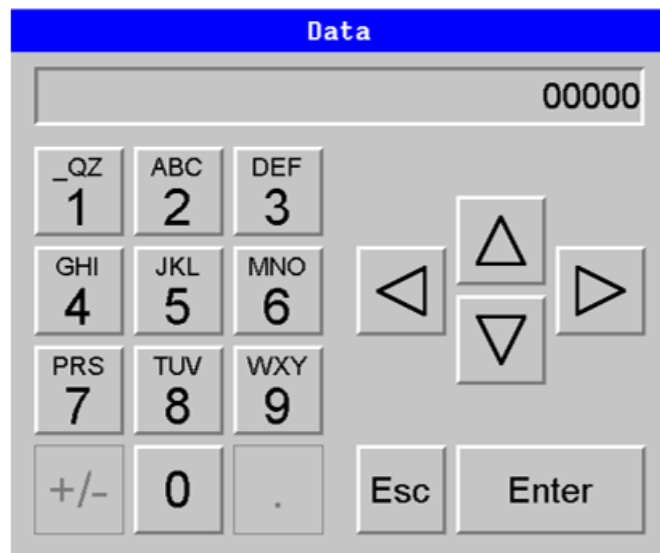

System Menu Map

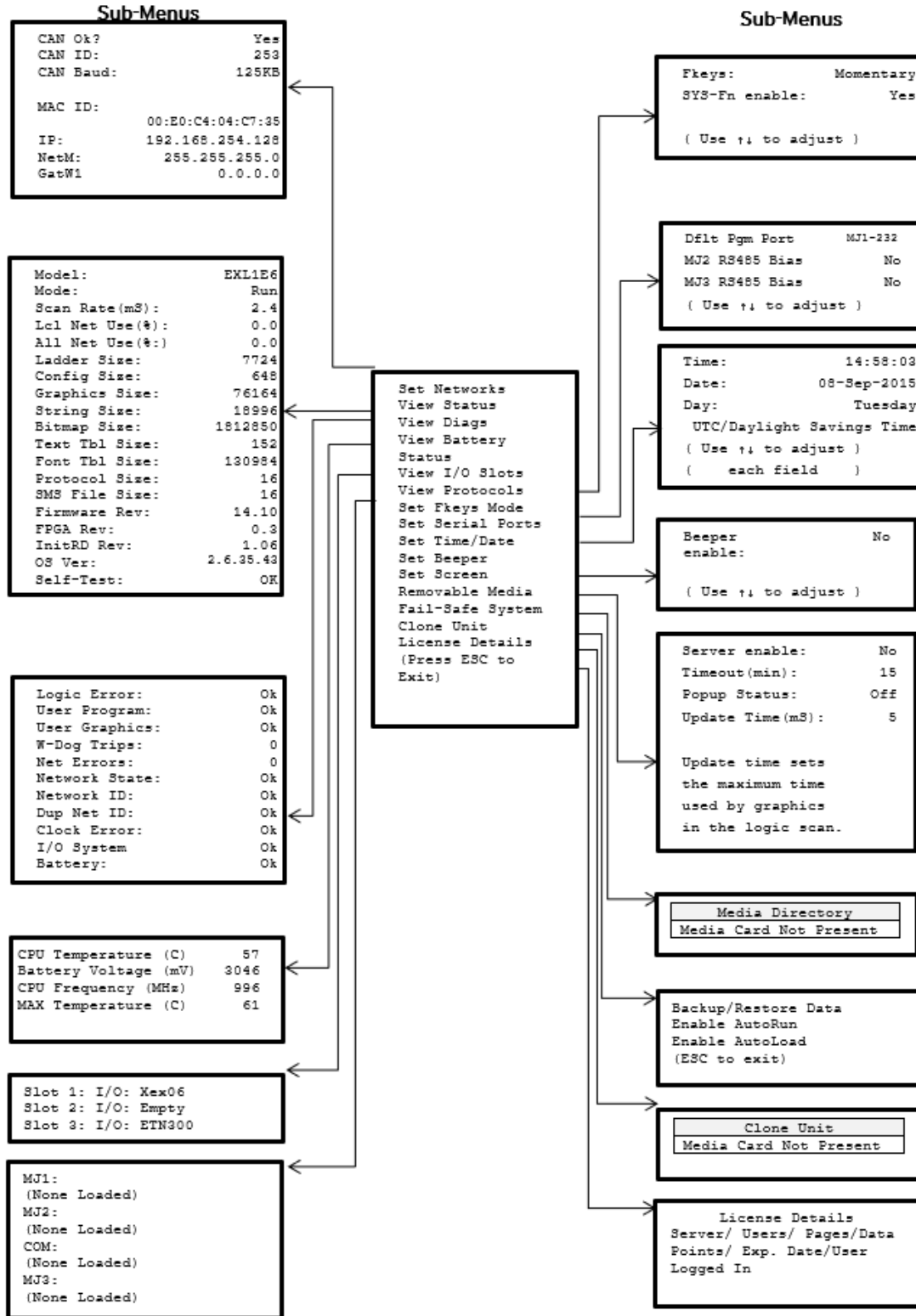

Set Networks

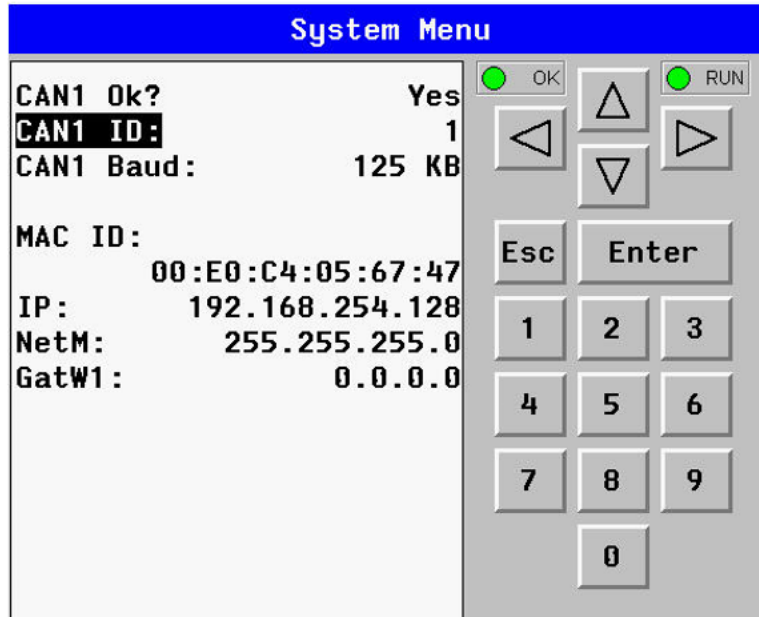

This sub menu allows setting for the CAN and Ethernet network to be viewed or changed.

CAN Ok?	Yes = CAN1 connected to a CAN network and functioning properly No = Not ready to communicate on CAN network	
CAN ID	1 to 253 = This node's CsCAN Network ID; must be unique on network	
CAN Baud	125kB = 125kBd CAN network 250kB = 250kBd CAN network	500kB = 500kBd CAN network 1MB = 1MBd CAN network
MAC ID	Displays the Ethernet MAC ID of the unit	
IP	Displays the Ethernet IP address of the unit	
NetM	Displays the Ethernet net mask of the unit	
GatWy	Displays the Ethernet gateway of the unit	

NOTE: The IP address, Net Mask, and Gateway can be changed from the System Menu. This is designed for commissioning or temporary field changes. The actual parameters are defined in Cscope under the Ethernet configuration.

View Status & Diags

View Status

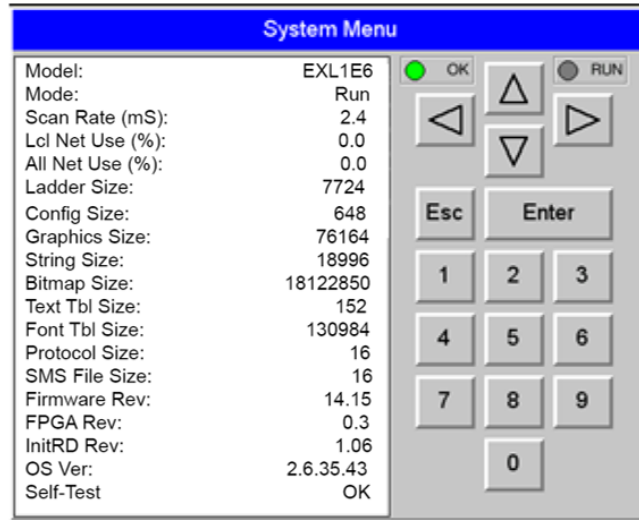

The View Status Sub-Menu displays up to 19 System Settings. Only the Mode System Setting is editable.

Model:	XW1yz = Model number of this EXL6/XL6 PRIME OCS unit 1yz = indicates the installed I/O module 00 = no I/O module
Mode:	Idle = EXL6/XL6 PRIME OCS is in Idle mode DoIO = EXL6/XL6 PRIME OCS is in Do I/O mode Run = EXL6/XL6 PRIME OCS is in Run mode
Scan Rate (mS):	0.0 = EXL6/XL6 PRIME OCS is not in Run mode 0.1 to 999.9 = Average number of mS for each ladder scan
Lcl Net Use %:	0.0 to 100.0 = CAN network bandwidth % used by this OCS node
All Net Use %:	0.0 to 100.0 = CAN network bandwidth % used by all nodes
Ladder Size:	x = Number of bytes in application ladder program
Config Size:	x = Number of bytes in application I/O configuration
Graphics Size:	x = Number of bytes in application graphic screens
String Size:	x = Number of bytes in application string table
Bitmap Size:	x = Number of bytes in application bitmaps
Text Tbl Size:	x = Number of bytes in application text tables
Font Tbl Size:	x = Number of bytes in application font tables
Protocol Size:	x = Number of bytes in application downloaded protocols
SMS File Size:	x = Number of bytes in application SMS protocol configuration
Firmware Rev:	xx.yy = Current firmware version
FPGA Rev:	x.y = Current FPGA version (High Speed IO Sub System)
InitRD Rev:	x.yz = Bootloader version
OS Ver:	a.b.cd.yz = Current Operating System version
Self-Test	Ok = All power-on self-tests passed Fault = One or more power-on self-tests failed

View Diags

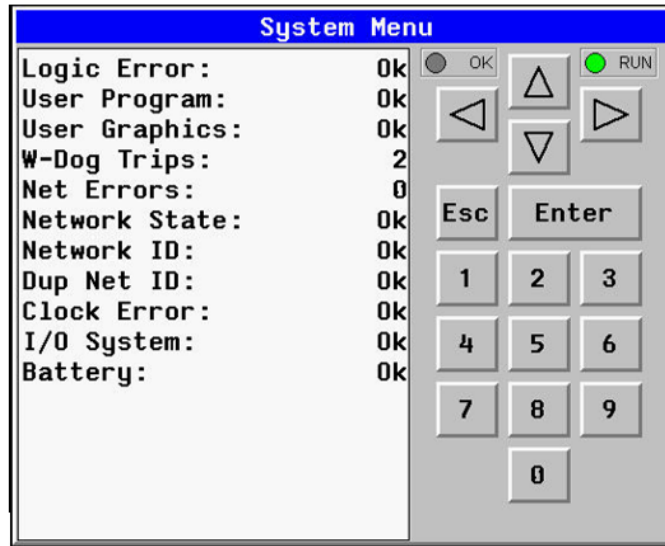

The View Diags Sub-Menu displays up to 11 System Diagnostics, none of which are editable. The first two System Diagnostics are critical. If any of them indicate a Fault condition, the OCS will not enter or remain in Run mode, and the problem must be investigated and corrected.

Logic Error:	Ok = All executed ladder instructions are legal for loaded firmware Fault = A ladder instruction not supported by firmware was found
User Program:	Ok = Ladder program and I/O configuration loaded successfully Fault = Ladder program or I/O configuration not loaded or load failed

The last nine System Diagnostics are informational. If any of them indicate a Warning condition, the OCS can still enter and remain in Run mode, but the problem should be investigated and corrected.

User Graphics:	Ok = Application graphics objects loaded successfully Fault = Application graphics objects not loaded or load failed
W-Dog Trips:	0 = Watchdog timer has not tripped since the last power-up x = Number of times watchdog timer has tripped
Net Errors:	0 = No CAN network bus-off errors have occurred x = Number of CAN network bus-off errors that have occurred
Network State:	Ok = At least one other node was found on the CAN network Warning = No other nodes were found on the CAN network
Network ID:	Ok = This node's CAN Network ID is in the range 1 to 253 Warning = This node's CAN Network ID was out of range at power-up
Dup Net ID:	Ok = This node's Network ID is unique on the CAN network Warning = This node's Network ID is duplicated in another node
Clock Error:	Ok = Time and date have been set Warning = Time and date need to be set
I/O System:	Ok = I/O configuration matches the installed I/O and COM modules Warning = I/O configuration needs updating to match installed modules
Battery:	Ok = Backup battery operating properly Warning = Backup battery needs to be replaced

View Battery Status, I/O Slots & Protocols

View Battery

See also: "EXL6 Rechargeable Battery" on page 182

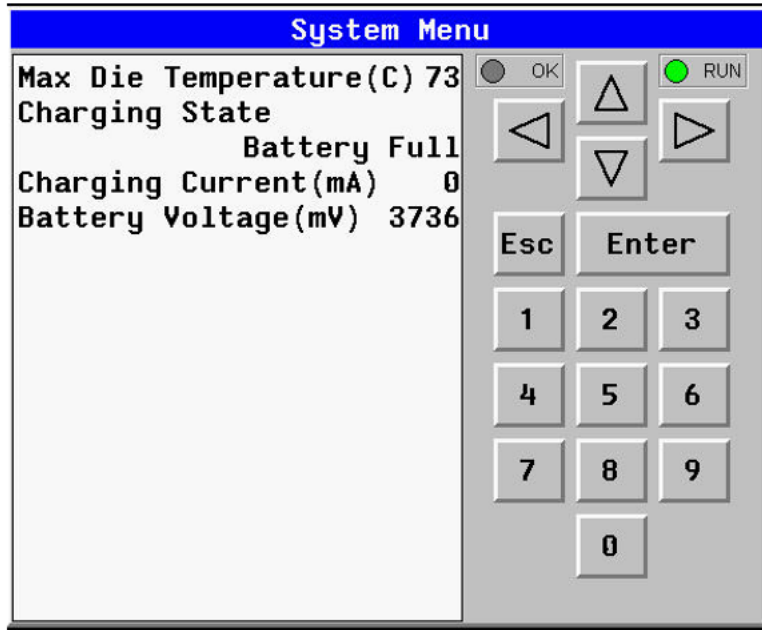

The View Battery Status displays the following information.

Waiting	The charging system is waiting for voltages and temperatures to stabilize.
Battery Charging	The battery is charging.
Battery Full	Shows at the end of a charge cycle. Remains in this state until the battery is steadily discharging.
Battery Discharging	The battery is steadily discharging.

View I/O Slots

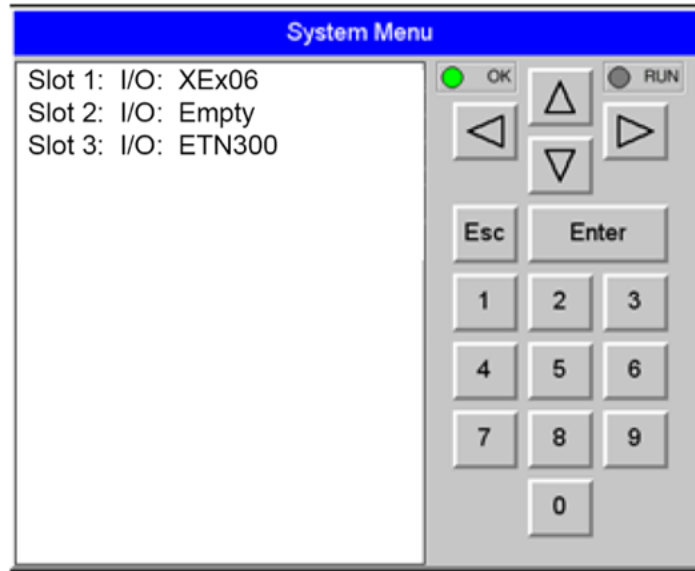

The View I/O Slots Sub-Menu displays three System Settings, all of which are **not** editable.

Internal to the OCS, there is a CPU board, and up to two installed modules. Model 0 has no installed I/O or COM modules. All other models have an I/O module and can have a user-installed COM module.

Depending on which I/O module is installed and which I/O module has been configured by Cscape, one of the following six System Settings should appear for Slot 1:

Slot 1: I/O: Empty	= No I/O module installed or configured
Slot 1:*Unsupported	= Unsupported I/O module installed
Slot 1:-I/O Missing	= No I/O module installed but an I/O module is configured
Slot 1:+I/O: XExyy	= yy I/O module installed but no I/O module configured
Slot 1:?I/O: XExyy	= yy I/O module installed but another I/O module configured
Slot 1: I/O: XExyy	= yy I/O module installed and configured properly

Depending on the COM module that is installed and the COM module that has been configured by Cscape, one of the following six System Settings appears for Slot 2:

Slot 2: I/O: Empty	= No COM module installed or configured
Slot 2:*Unsupported	= Unsupported COM module installed
Slot 2:-I/O Missing	= No COM module installed but a COM module is configured
Slot 2:+I/O: XzC	= z COM module installed but no COM module configured
Slot 2:?I/O: XzC	= z COM module installed but another COM module configured
Slot 2: I/O: XzC	= z COM module installed and configured properly

Slot 3: I/O: ETN300	= ETN300 has been configured through Cscape
---------------------	---

View Protocols

See also: "Protocol Configuration " on page 130

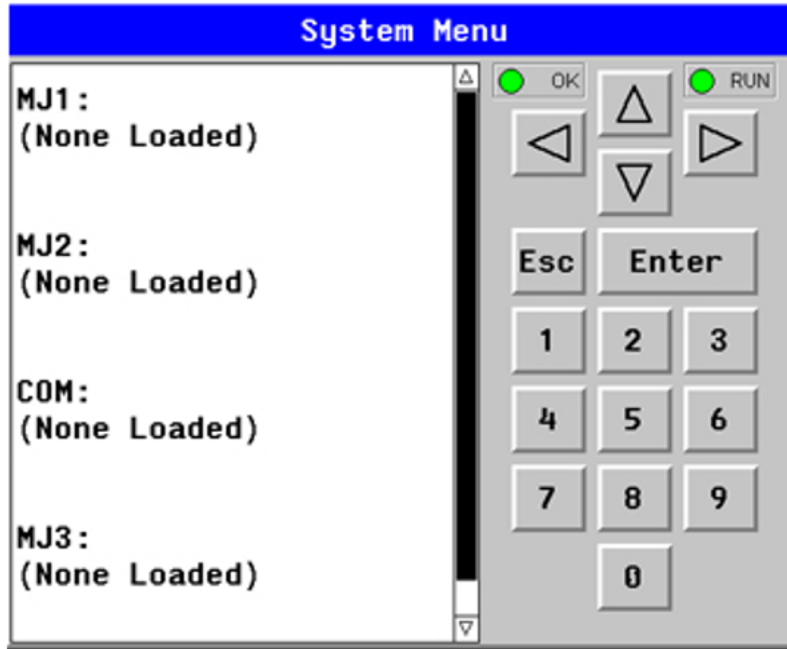

The View Protocols Sub-Menu displays three System Settings, none of which are editable.

As mentioned in Downloadable Serial Communication Protocols section, both the MJ1 (Port 1) and MJ2 (Port 2) serial ports support downloadable protocols. To assign a downloadable protocol to an OCS serial port, select the Protocol Config item in Cscape's Program menu and then setup a protocol for Port 1 or Port 2 (or both).

In the View Protocols Sub-Menu, the currently downloaded protocol, if any, and its version number are displayed for both Port 1 and Port 2.

Port 1	
Protocol Name	(None Loaded) or name of the protocol assigned to MJ1
Protocol Version	Blank or version of the protocol assigned to MJ1
Port 2	
Protocol Name	(None Loaded) or name of the protocol assigned to MJ2
Protocol Version	Blank or version of the protocol assigned to MJ2

Set Fkeys Mode, Serial Ports, Ethernet, Time/Date, Beeper & Screen

Set Fkeys Mode

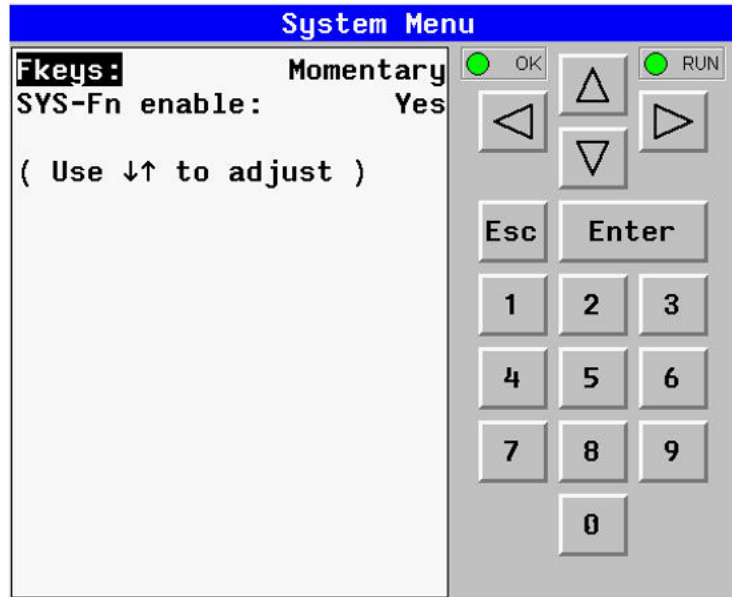

The Set Fkeys Sub-Menu displays two System Settings, both of which are editable.

Fkeys	Momentary = %K1-5 bits go On & Off as F1-F5 are pressed & released Toggle = %K1-5 bits toggle each time F1-F4 are pressed
SYS_Fn enable	Yes = Reset and all clear system functions enabled No = Reset and all clear system functions disabled

Set Serial Ports

See also: "Serial Communications" on page 117

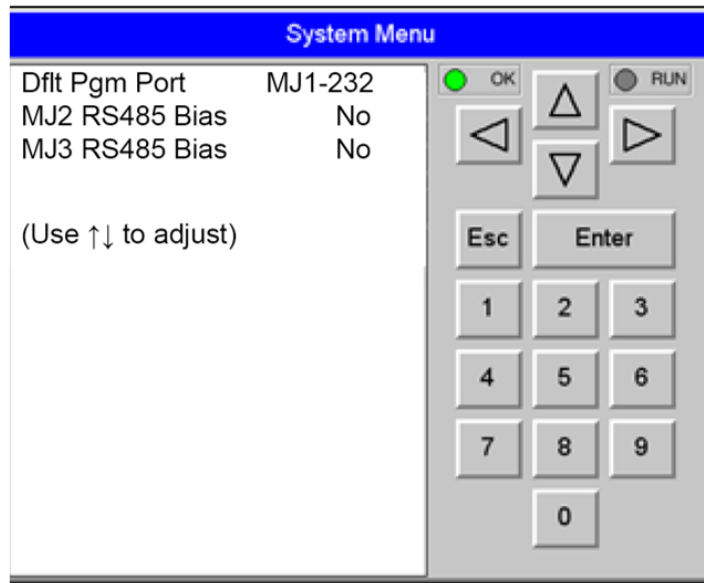

The Set Serial Ports Sub-Menu displays three System Settings, all of which are editable, and one optional item. For the **Dflt Pgm Port** System setting, only MJ1-232 can be selected, unless a Modem (XMC) COM module is installed.

Dflt Pgm Port	MJ1-232 = MJ1 RS232 port is the default programming port Modem = Modem COM module is the default programming port
MJ2 RS485 Bias	No = MJ2 RS485 bias resistors are not switched in Yes = MJ2 RS485 bias resistors are switched in

Set Time/Date

The following instructions are to set and display the real-time clock in the controller. More details can be found in the Help File in Cscape.

Clock and Time Setting Terms	
Coordinated Universal Time (UTC)	Abbreviated to UTC, Coordinated Universal Time is the primary time standard by which the world regulates clocks and time.
Time Offset	In order to obtain the local time (anywhere in the world), the user needs to subtract / add a certain number of hours from UTC depending on how many time zones user is away from Greenwich.
Network Time Protocol (NTP)	A Networking Time Protocol (NTP) for clock synchronization between computer systems over packet-switched, variable latency data networks.
Daylight Saving Time	Time as adjusted to achieve longer evening daylight, especially in summer, by setting the clocks an hour ahead of the standard time.
Apply Daylight Saving (DST)	Daylight Saving Time (DST) is the practice of setting the clocks forward one hour from standard time during the summer months, and back again in the fall, in order to make better use of natural daylight. Selecting this option increases the Time offset by 1 hour.

System Registers for UTC (Coordinated Universal Time)	
%SR210 (R/W)	Time Zone: set in hours + / - UTC.
%SR211 (R/W)	Daylight Saving: YES = 1 Daylight Saving: NO = 0 (If daylight saving is enabled, one hour will be added to the local time).
%SR212 (R)	UTC – Seconds
%SR213 (R)	UTC – Minutes
%SR214 (R)	UTC – Hours
%SR215 (R)	UTC – Date
%SR216 (R)	UTC – Month
%SR217 (R)	UTC – Year

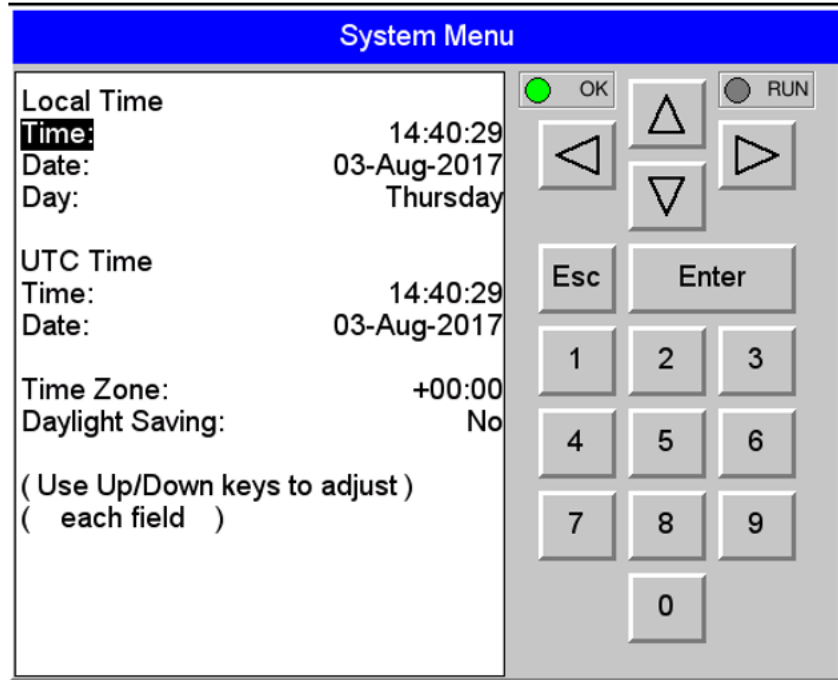

To Set Time Zone: The Time Zone setting is an hourly offset from UTC time. If using the Time Zone setting, set it first, then set the local time. UTC time will be automatically set based on the time zone and local time settings. If using NTP: NTP utilizes UTC time, therefore when using NTP, the appropriate hourly offset from UTC time must be entered into the time zone setting.

Daylight Saving Time: If currently observing Daylight Saving Time, set to Yes. If not currently observing Daylight Saving Time, set to No. The OCS controller does not automatically switch to daylight saving time; however, program logic can be written to accomplish an automatic switchover using system register %SR211. In program logic, move a "1" (INT) into %SR211 to enable Daylight Saving Time. Move a "0" (INT) into %SR211 to disable Daylight Saving Time. Trigger the move to %SR211 based on a compare function to the RTC date according to daylight saving practices in your desired region.

To Set Local Time: The Set Time/Date sub-menu displays three system settings. Time and Date may be edited, and Day is automatically calculated from the Date setting.

NOTE: Time and Date are split into three fields each, all of which may be edited. Touch the field or use ↓ or ↑ buttons to select a field, then use the ↓ or ↑ buttons to edit the field.

Time	16:09:49 = Current time (hours:minutes:seconds in 24-hour format)
Date	10-Jun-2013 = Current date (day-month-year)
Day	Monday = Current day of week calculated from the Date setting

Set Beeper

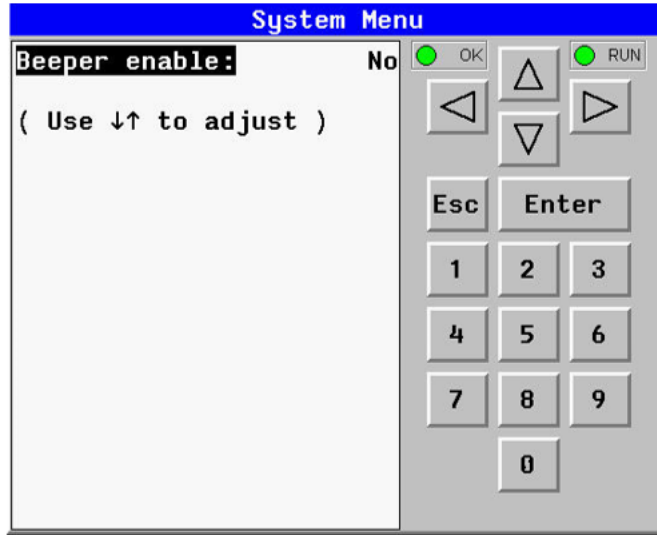

The Set Beeper Sub-Menu displays one System Setting, which is editable.

Beeper Enable	Yes (default) = Enables beeper No = Disables beeper (does NOT affect ladder access)
---------------	--

Set Screen

The Set Screen Sub-Menu displays four System Settings, all of which are editable.

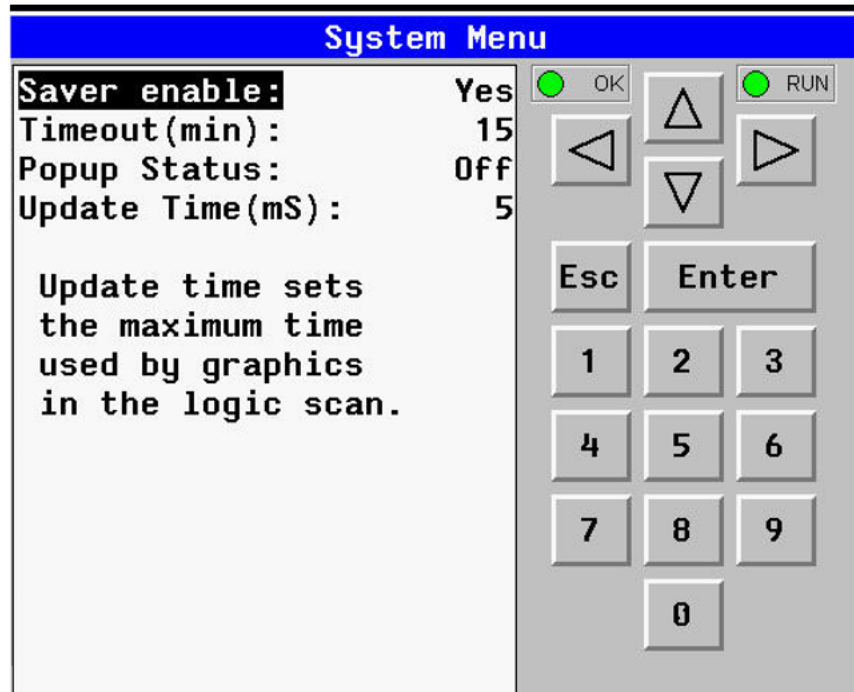

Saver enable	Yes = Enable screen saver No (default) = Disable screen saver
Timeout (min)	5 - 1200 = Amount of time in minutes to expire with NO touch activity before activating screen saver (black screen)
Popup Status	Off (default) = Disable popup status Warning = Display popup status only if controller status changes to NOT Ok or NOT Run mode. On = Display popup status on any controller status change.
Update Time (mS)	2 - 50 = Maximum amount of time to allow for graphics update per scan

Removable Media

See also: "Removable Media" on page 159

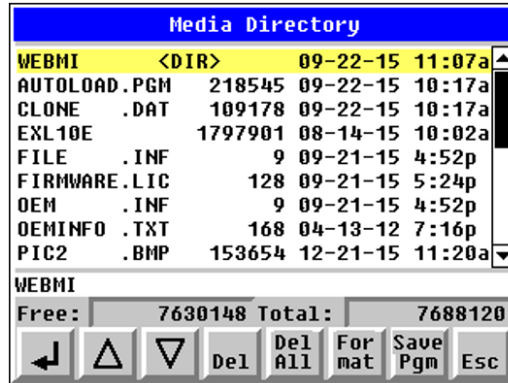

The Removable Media Sub-Menu displays the Removable Media Manager. After selecting Removable Media from the Main Menu, one of four Sub-Menu screens will appear:

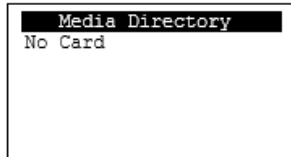

= No microSD card has been installed in the Memory slot

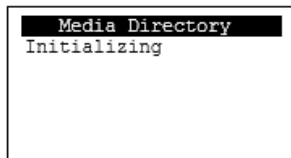

= microSD card is installed, but it is still initializing

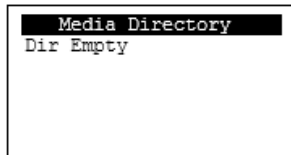

= microSD card is installed and initialized, but contains no files

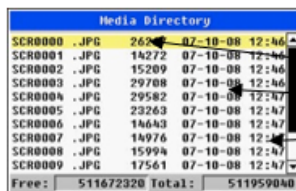

= microSD card is installed and initialized, and it contains files

Shows size of highlighted file or shows <DIR> if directory is highlighted.

Shows the date file or directory was created or last modified.

Shows the time file or directory was created or last modified.

Scrollbar

If a directory name is highlighted, pressing Enter will switch to that directory showing its files and sub-directories. In a sub-directory, highlighting .. (dot dot) and pressing Enter will move up one directory.

Fail – Safe System

See also: "Fail-Safe System" on page 169

The Fail-Safe System is a set of features that allow an application to continue running in the event of certain types of "soft" failures. These "soft" failures include:

- Battery power loss
- Battery-Backed Register RAM or Application Flash corruption due to, for example, an excessive EMI, Electromagnetic Interference, event.

Selecting "Fail-Safe System" menu will open the following menu screen:

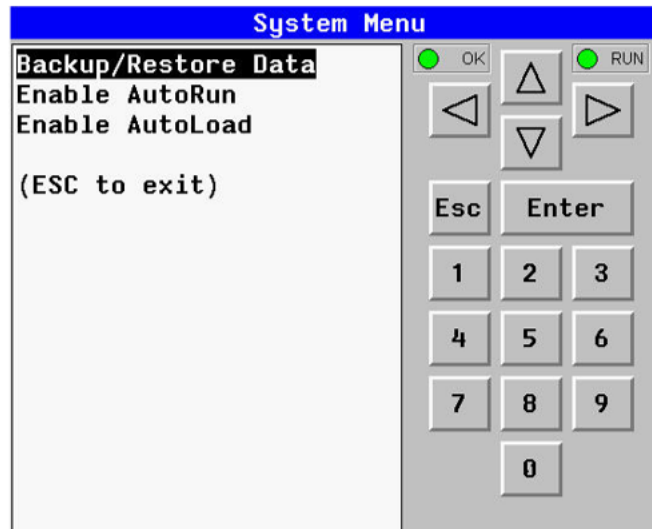

Selecting Backup/Restore Data displays the following screen in:



Backup	= Copies battery-backed RAM contents on to the onboard flash memory of the OCS.
Restore	= Copies the backed-up data from onboard flash to the battery-backed RAM.
Clear Backup	= The backup data will be erased from the onboard flash.
Exit	= Goes back to previous menu

Enable AutoRun

“Enable AutoRun” displays the following options which can be selected:



Enable AutoRun	No = OCS will be in IDLE mode after AutoLoad or Automatic Restore. Yes = OCS will automatically be placed into RUN mode after AutoLoad or Automatic Restore.
----------------	---

Enable AutoLoad

“Enable AutoLoad” displays the following options which can be selected:

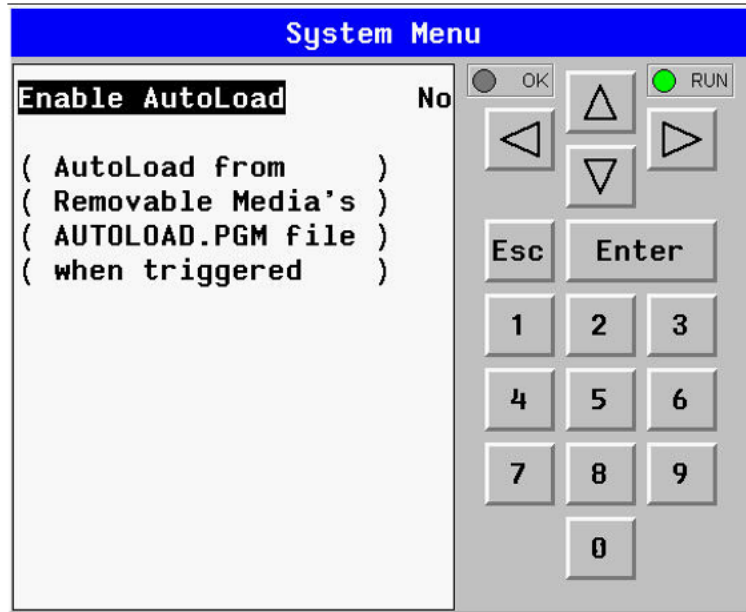

Enable AutoLoad	<p>No = Does not load AUTOLOAD.PGM automatically when application program is absent or corrupted. Yes = Loads AUTOLOAD.PGM file automatically from RM when application program is absent or corrupted.</p>
-----------------	---

Clone Unit

See also: "Clone Unit" on page 165

'Clone Unit' feature allows the user to "clone" the OCS of the exact same model. This feature "clones" application program and unit settings stored in battery-backed RAM of an OCS into the RM. Refer to "Removable Media" on page 159 for details on using RM. It can then be used to clone a different OCS (same model).

This feature can be used for:

- Replacing an OCS by another unit of the same model.
- Duplicating or "clone" units without a PC.

Make Clone

Selecting "Clone Unit" menu will open the following menu screen:

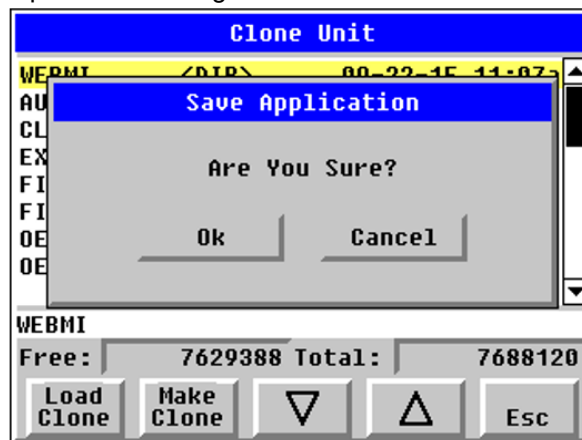

Load Clone and **Make Clone** virtual buttons are below the screen. **Free/Total**: Displays number of Free and Total bytes in Removable Media.

Selecting Make Clone brings up the screen below for the user:

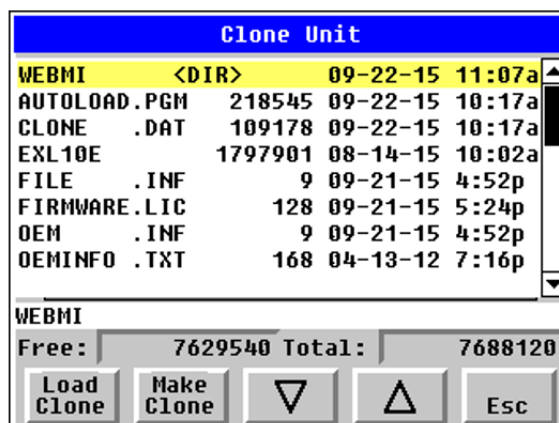

After confirmation, the OCS will create two new files in the root directory of the Removable Media Drive as shown below:

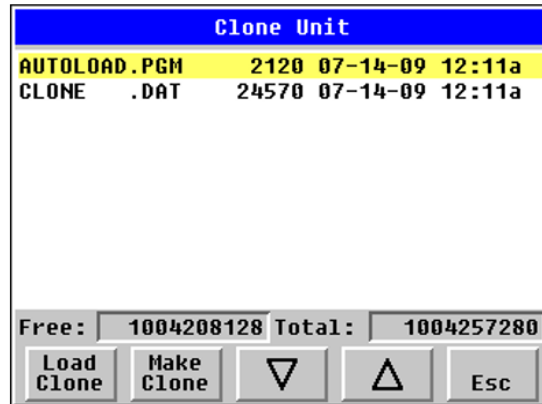

AUTOLOAD.PGM	Application file
CLONE.DAT	File having all unit settings and register values from battery-backed RAM

Load Clone

Selecting "Clone Unit" menu will open the following menu screen. Select "Load Clone" (one of the virtual buttons beneath the screen).

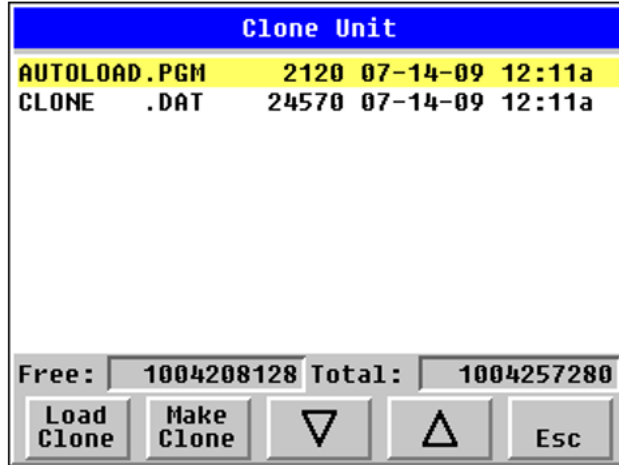

NOTE: For security enabled files, Load Clone asks for password validation before loading the application.

WebMI License Details

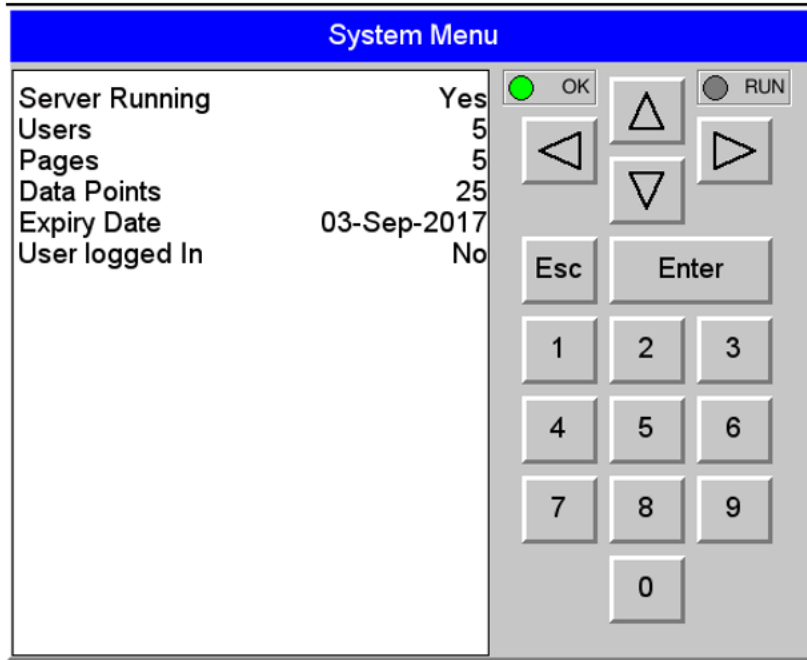

License details page displays the information about the WebMI license. Please refer to MAN1036 for the WebMI Manual using Horner's [Documentation Search](#) page. The information can also be viewed from Cscape using the following %SR registers:

%SR209.3	WebMI server status
%SR209.4	WebMI user logged in status
%SR209.9 to SR209.16	Number of Users
%SR218	Number of Webpages
%SR219	Number of Data Points
%SR220-SR222	Expiry Date of WebMI License

Touch Screen Calibration

The touch screen is calibrated at the factory and rarely needs modification. However, if actual touch locations do not appear to correspond with responding objects on the display, field adjustment is available. Ensure SYS_fn Enable is set to YES in System Menu. To access the field adjustable touch screen calibration dialog, press and hold both the SYS and F1 key for longer than 2 seconds and a dialog similar to the figure below will appear.

For best results in screen calibration, use a stylus with a plastic tip. When the crosshair appears, touch the center of the crosshair as exactly as possible and release. A small “+” should appear and will move closer to the center of the crosshair. Once it has done so and disappeared again, repeat the process until “+” appears in the center of the crosshair. Then move on to the next step.

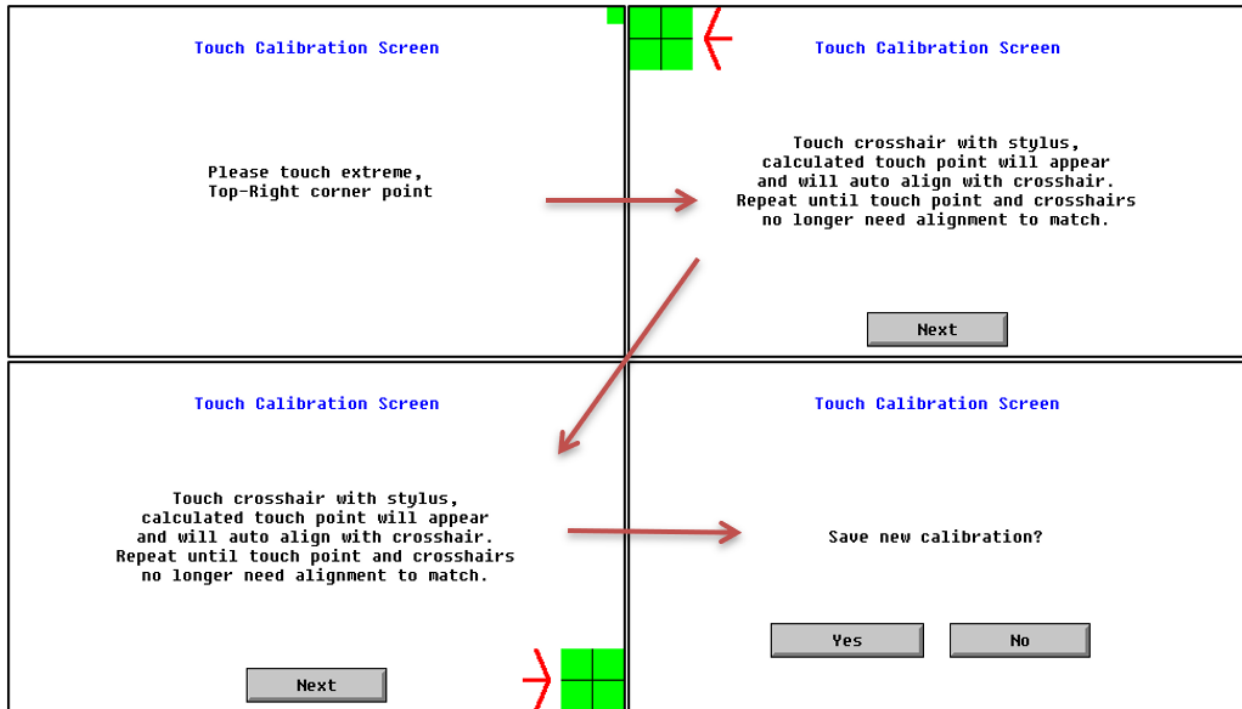

System Registers



System Register Tables

Register Definitions	50
%S Registers	51
%SR Registers	52
I/O Register Map for EXL6 & XL6 Prime	59
PWM Function Registers Map	59
HSC Functions Registers Map	60
EXL6 & XL6 Prime Resource Limits	60

There are two types of System Registers that may be used during programming. %S registers indicate the status of several system operations. %SR registers indicate the state of many system operations and can be used to control them in several cases. Some of the system registers have predefined I/O names, though they may still be changed if desired.

Register Definitions

When programming the an OCS, data is stored in memory that is segmented into different types. This memory in the controller is referred to as registers. Different groups of registers are defined as either bits or words (16 bits). Multiple registers can usually be used to handle larger storage requirements. For example, 16 single-bit registers can be used to store a word, or two 16-bit registers can be used to store a 32-bit value.

Types of Registers	
%AI = Analog Input	16-bit input registers used to gather analog input data such as voltages, temperatures, and speed settings coming from an attached device.
%AQ = Analog Output	16-bit output registers used to send analog information such a voltages, levels or speed settings to an attached device.
%D = Display Bit	These are digital flags used to control the displaying of screens on a unit which has the ability to display a screen. If the bit is SET, the screen is displayed.
%I = Digital Input	Single-bit input registers. Typically, an external switch is connected to the registers.
%K = Key Bit	Single-bit flags used to give the programmer direct access to any front panel keys appearing on a unit.
%M = Retentive Bit	Retentive single-bit registers.
%Q = Digital Output	Single-bit output registers. Typically, these bits are connected to an actuator, indicator light or other physical outputs.
%R = General Purpose Register	Retentive 16-bit registers.
%S = System Bit	Single-bit bit coils predefined for system use.
%SR = System Register	16-bit registers predefined for system use.
%T = Temporary Bit	Non-retentive single-bit registers.

%S Registers

%S registers indicate system status as follows:

S#	Name	Predefined I/O Name	Notes
%S1	First Scan	FST_SCN	On for 1 scan only each time the program is first run
%S2	Network OK	NET_OK	If on, the Network is OK
%S3	10ms pulse	T_10MS	Cycling pulse that is high for 5ms and low for 5ms
%S4	100ms pulse	T_100MS	Cycling pulse that is high for 50ms and low for 50ms
%S5	1 second pulse	T_1SEC	Cycling pulse that is high for 500ms and low for 500ms
%S6	I/O OK	IO_OK	If on, the I/O system is OK
%S7	Always On	ALW_ON	This bit is always on
%S8	Always OFF	ALW_OFF	This bit is always off
%S9	Pause Scan	PAUSING_SCN	On for at least 1 scan prior to Pause 'n Load
%S10	Resume Scan	RESUMED_SCN	On for 1 scan only after Pause 'n Load is done
%S11	Forcing Present	FORCE	If on, I/O is presently being forced
%S12	Forcing Enabled	FORCE_EN	If on, I/O forcing is been enabled
%S13	Net I/O OK	NET_IO_OK	If on, Network I/O is OK

%SR Registers

%SR registers are special word-length registers that display and/or control system operations in the controller. Not all controllers support all defined system registers. Click on the name of the register to see more information on that register.

SR #	Name and Description	Default I/O Name	Min - Max Values	Program (Read/Write)	Display (Read/Write)
%SR1	User Screen Number (0=none)	USER_SCR	0 to 1023	Read/Write	Read/Write
%SR2	Alarm Screen Number	ALRM_SCR	0 to 1-23	Read Only	Read Only
%SR3	System Screen Number 1= Main System Menu 2= Set Network ID, Network Status, (%SR29) 3= Set Network Baud (%SR30) 4= Set Contrast (%SR32) 5= View OCS Status 6= View OCS Diagnostics 7= View I/O Slots 8= Set Function Key Mode (%SR33) 9= Set Serial Ports (%SR34) 10= Set Time/Date (%SR44-%SR50) 11= Set Beeper (%SR183) 12= Set Screen (%SR185) 13= Removable Media 14= View Protocols 15= IP Address IP Address (ETN I/O Board) 16= Fail Safe System 17= Backup / Restore Data 18= Enable AutoRun 19= Enable AutoLoad 20= Clone Unit - 21= Touch Calibration 24= License Details	SYS_SCR	0 to 24	Read/Write	Read/Write
%SR4	Self Test Results	SELF_TEST		Read Only	Read Only
%SR4.1	Self Test Results - BIOS Error			Read Only	Read Only
%SR4.2	Self Test Results - Engine Error			Read Only	Read Only
%SR4.3	Self Test Results - Ladder Error			Read Only	Read Only
%SR4.4	Self Test Results - RAM Error			Read Only	Read Only
%SR4.5	Self Test Results - Duplicate ID Error			Read Only	Read Only
%SR4.6	Self Test Results - Bad ID Error			Read Only	Read Only
%SR4.7	Self Test Results - I/O Configuration Error			Read Only	Read Only
%SR4.8	Self Test Results - Bad Network Error			Read Only	Read Only
%SR4.9	Self Test Results - Bad Logic Error			Read Only	Read Only
%SR4.10	Self Test Results - Bad Clock Error			Read Only	Read Only
%SR4.11	Self Test Results - DeviceNet Error			Read Only	Read Only
%SR4.12 - 16	Reserved				
%SR5	Control Station Mode 0= Idle 1= Do I/O 2= Run 3= Online Change	CS_Mode	0 to 3	Read Only	Read/Write

%SR6	Average Scan Rate ms (/ 10)			Read Only	Read Only
%SR7	Minimum Scan Rate ms (/ 10)			Read Only	Read Only
%SR8	Maximum Scan Rate ms (/ 10)			Read Only	Read Only
%SR9	Current Touch Pressure	TCH_PRESSURE	0 to 3000	Read Only	Read Only
%SR10	Threshold Touch Pressure	TCH_PRESSURE_TSH	0 to 3000	Read/Write	Read/Write
%SR11-12	Ladder Size (32-Bit DINT)			Read Only	Read Only
%SR13-14	User Text Screen Size (32-Bit DINT)			Read Only	Read Only
%SR15-16	System Text Screen Size (32-Bit DINT)			Read Only	Read Only
%SR17-18	I/O Configuration Table Size (32-Bit DINT)			Read Only	Read Only
%SR19-20	Network Config Table Size (32-Bit DINT)			Read Only	Read Only
%SR21-22	Security Data Table Size (32-Bit DINT)			Read Only	Read Only
%SR23	Ladder Code CRC			Read Only	Read Only
%SR24	User Text CRC			Read Only	Read Only
%SR25	System Text CRC			Read Only	Read Only
%SR26	I/O Configuration Table CRC			Read Only	Read Only
%SR27	Network Configuration Table CRC			Read Only	Read Only
%SR28	Security Data Table CRC			Read Only	Read Only
%SR29	Network ID	NET_ID		Read Only	Read/Write
	CsCAN Mode		1 to 253		
	DeviceNet Mode		0 to 63		
	CANopen Mode		1 to 127		
%SR30	Network Baud Rate 0=125KB 1= 250kB 2= 5000KB 3= 1MB 4=50K		0 to 4	Read Only	Read/Write
%SR31	Network Required 0= Network not required 1= Network required; 2= Network optimized; 3= Network required and optimized		0 to 3	Read Only	Read Only
%SR32	LCD Display Contrast setting		0 to 255	Read Only	Read/Write
%SR33	Function Key Toggle Mode 0= Momentary 1= Toggle		0 to 1	Read/Write	Read/Write
%SR34	RS232 Serial Protocol Mode 0= Firmware Update (RISM) 1= CsCAN 2= Generic (Ladder- Controlled) 3= Modbus RTU 4= Modbus ASCII			Read Only	Read Only
%SR35-36	Unique Serial Number / Hexadecimal I LAN1 MAC ID			Read Only	Read Only
%SR37	Model Number			Read Only	Read Only
%SR38	Engine Version (/100)			Read Only	Read Only
%SR39	BIOS Rev Number (/ 100)			Read Only	Read Only
%SR40	FPGA Image Rev Number (/ 10)			Read Only	Read Only
%SR41	Vertical Pixel Count			Read Only	Read Only
%SR42	Horizontal Pixel Count			Read Only	Read Only

%SR43	Keypad Type			Read Only	Read Only
%SR44	Real-Time-Clock Second	RTC_SEC	0 to 59	Read Only	Read Only
%SR45	Real-Time-Clock Minute	RTC_MIN	0 to 59	Read Only	Read Only
%SR46	Real-Time-Clock Hour	RTC_HOUR	0 to 23	Read Only	Read Only
%SR47	Real-Time-Clock Date	RTC_DATE	1 to 31	Read Only	Read Only
%SR48	Real-Time-Clock Month	RTC_MONTH	1 to 12	Read Only	Read Only
%SR49	Real-Time-Clock Year	RTC_YEAR	1996 to 2095	Read Only	Read Only
%SR50	Real-Time-Clock Day (1=Sunday)	RTC_DAY	1 to 7	Read Only	Read Only
%SR51	Network Error Count			Read Only	Read Only
%SR52	Watchdog-Tripped Error Count			Read Only	Read Only
%SR53-54	Reserved				
%SR55.13	Self-Test: Battery Low or Missing			Read Only	Read Only
%SR56	Key Currently Pressed No key = 0 (No key pressed since power-up) F1 = 1 F2 = 2 F3 = 3 F4 = 4 F5 = 5 F6 = 6 F7 = 7 F8 = 8 F9 = 9 F10 = 10 F11 = 11 F12 = 12 Enter = 13 +/- = 14 . (dot) = 15 0 = 16 1 = 17 2 = 18 3 = 19 4 = 20 5 = 21 6 = 22 7 = 23 8 = 24 9 = 25 System = 26 Escape = 27 Left = 28 Right = 29 Up = 30 Down = 31 Shift = 32 Soft Key 1 = 34 Soft Key 2 = 35 Soft Key 3 = 36 Soft Key 4 = 37 Soft Key 5 = 38 Soft Key 6 = 39 Soft Key 7 = 40 Soft Key 8 = 41 Release = 255 (Keys pressed since power-up but not currently)	LAST_KEY	0 to 255	Read Only	Read Only
%SR57	LCD Backlight Dimmer Register		0 to 255	Read Only	Read Only

	0-100 = 0% to 100% On 100-255 = 100% On				
%SR57.16	Temporarily disable Screen Saver			Read/Write	Read/Write
%SR58	User LEDs	USER_LEDS		Read/Write	Read/Write
%SR59	Engine Build Number (Only last three numbers displayed)			Read Only	Read Only
%SR60	Build Option Build Test = 0 Build Beta = 1 Build Product = 2		0 to 2	Read Only	Read Only
%SR61	Number of CsCAN Network IDs	NUM_IDS		Read Only	Read Only
%SR62-130	Reserved				
%SR131-135	OCS Model: ASCII, 10 characters			Read Only	Read Only
%SR136	Communication Download Timeout			Read Only	Read Only
%SR137	Communication Idle Timeout			Read Only	Read Only
%SR138-148	Reserved				
%SR149-150	Free-running 10kHz count: 1 count = 0.1ms (32-Bit DINT)			Read Only	Read Only
%SR151	Reserved				
%SR152	RS-485 Termination			Read/Write	Read/Write
%SR152.1	MJ2 Termination Enable			Read/Write	Read/Write
%SR153 - 163	Reserved				
%SR164	FailSafe / Clone				
%SR164.1	RS485 Port Biasing #1 (MJ1 or MJ2)			Read/Write	Read/Write
%SR164.2	RS485 Port Biasing #2 (MJ2 or MJ3)			Read/Write	Read/Write
%SR164.3	Indicates Automatic Restore Oper- ation has been performed	AUTO_RESTRD		Read Only	Read Only
%SR164.4	Indicates Backup of Registers has been taken	BCKUP_TAKN		Read Only	Read Only
%SR164.5	Enable AUTORUN – Sets “Enable AutoRun” to “Yes” or “No”	EN_AUTO_LD		Read/Write	Read/Write
%SR164.6	Enable AUTOLOAD – Sets “Enable AutoLoad” to “Yes” or “Not”	EN_AUTO_LD		Read/Write	Read/Write
%SR164.7	Start Backup trigger bit – Setting TRUE starts backup of all register data	STRT_BCKUP		Read/Write	Read/Write
%SR164.8	Clear Backup trigger bit – Setting TRUE clears backup of all register data (if a backup was done previously)	CLR_BACKUP		Read/Write	Read/Write
%SR164.9	MAKE_CLONE trigger bit = Setting TRUE does a Load Clone (if a media card is present)	MAKE_CLONE		Read/Write	Read/Write
%SR164.10	LOAD_CLONE trigger bit – Setting TRUE does a LOAD CLONE	LOAD_CLONE		Read/Write	Read/Write

	(if a media card is present that contains clone files)				
%SR164.11	Make Clone Fail (This bit goes high when Make/Create Clone fails)	MK_CLN_FL		Read/Write	Read/Write
%SR164.12	Load Clone Fail (This bit goes high when Load Clone fails)	LD_CLN_FL		Read/Write	Read/Write
%SR164.14	Reserved			Read/Write	Read/Write
%SR164.15	Reserved			Read/Write	Read/Write
%SR165-166	Reserved				
%SR167	Screen Update Time, Default= 5		2 to 50	Read/Write	Read/Write
%SR168-170	Reserved				
%SR171	X-Coordinate Touched			Read Only	Read Only
%SR172	Y-Coordinate Touched			Read Only	Read Only
%SR173	System-Function Disable		0 to 1	Read/Write	Read/Write
%SR174	Removable Media Protect			Read/Write	Read/Write
%SR174.1	Request Media Card be Removed			Read/Write	Read/Write
%SR174.2	Indicates safe to remove Media Card			Read/Write	Read/Write
%SR175	Removable Media - Status			Read Only	Read Only
%SR176-177	Removable Media Free Space (32-Bit DINT)			Read Only	Read Only
%SR178-179	Removable Media Total Space (32-Bit DINT)			Read Only	Read Only
%SR180	Reserved				
%SR181	Bits 1-16 indicate Unacknowledged in Alarm Groups 1-16	ALM_UNACK		Read Only	Read Only
%SR182	Bits 1-16 indicate Active in Alarm Groups 1-16	ALM_ACT		Read Only	Read Only
%SR183	Beep on Keypress Enable 0= Disabled 1= Enabled	SYS_BEEP	0 to 1	Read/Write	Read/Write
%SR184	Internal Beeper 0=OFF 1=ON	USER_BEEP	0 to 1	Read/Write	Read/Write
%SR185	Screen Saver Enabled 0= Disabled 1= Enabled NOTE: See %SR57.16		0 to 1	Read Only	Read Only
%SR186	Screen Saver Time in minutes (delay)		5 to 1200	Read Only	Read Only
%SR187	Network Usage (Avg)	NET_USE	0 to 1000	Read Only	Read Only
%SR188	Network Usage (Min)		0 to 1000	Read Only	Read Only
%SR189	Maximum Net Usage of all units on the CAN network		0 to 1000	Read Only	Read Only
%SR190	Network TX Usage % (/ 10) (Avg)	NT_TX_AVG	0 to 1000	Read Only	Read Only
%SR191	Network TX Usage % (/ 10) (Min)		0 to 1000	Read Only	Read Only
%SR192	Network TX Usage % (/ 10) (Max)		0 to 1000	Read Only	Read Only
EXTENDED SYSTEM REGISTERS					
%SR193	Online Change	ONLINE_CHG			
%SR193.1	TRUE if 2 programs in target FLASH			Read Only	Read Only

%SR193.2	TRUE to switch programs, FALSE when complete			Read Only	Read Only
%SR193.3	TRUE if executing program is temporary test			Read Only	Read Only
%SR193.4	TRUE during last scan of switched-from program			Read Only	Read Only
%SR193.5	TRUE during first scan of switched-to program			Read Only	Read Only
%SR193.6	TRUE to revert to FLASH and delete all RAM; FALSE when complete			Read Only	Read Only
%SR193.9	TRUE if error in temporary program			Read Only	Read Only
%SR194	Battery Charge Temp Low			Read Only	Read Only
%SR195	Battery Charge Temp High			Read Only	Read Only
%SR196	Charging State NOTE: Refer to MAN1142 for more details on Rechargeable Batteries 0=Waiting 1=Normal Charging 2=Hot Charge 3=Hot Charge 4= Battery Hot 5= Cold Charge 6=Battery Cold 7=No Battery 8= Not Charging (after 8 hours of charging) 9= CPU Hot, not charging 10 Battery voltage <2V, not charging 11= First 2 minutes Init Wait (Not Charging)		0 to 11	Read Only	Read Only
%SR197	Charging Current Max mA			Read Only	Read Only
%SR198	Battery Voltage is mV			Read Only	Read Only
%SR199	Reserved				
%SR200	InitRD Version (/100)			Read Only	Read Only
%SR201 - 205	Linux Kernel version: ASCII, 10 characters			Read Only	Read Only
%SR206-208	Reserved				
%SR209.3	WebMI Server Status. Bit 3 is ON if server running.			Read Only	Read Only
%SR209.4	WebMI User Logged in Status. Bit 4 is ON if 1 or more users logged in.			Read Only	Read Only
%SR209.8 - 209.14	Number of Users. Shows in upper byte in decimal format.			Read Only	Read Only
%SR210	Time Zone: set in minutes + / -UTC (Ex: EST is -4 hours = -240 minutes)			Read/Write	Read/Write
%SR211	Daylight Saving: YES = 1 Daylight Saving: NO = 0 (If daylight saving is enabled, one hour will be added to the local time).			Read/Write	Read/Write

%SR212	UTC - Seconds			Read Only	Read Only
%SR213	UTC - Minutes			Read Only	Read Only
%SR214	UTC - Hours			Read Only	Read Only
%SR215	UTC - Date			Read Only	Read Only
%SR216	UTC - Month			Read Only	Read Only
%SR217	UTC - Year			Read Only	Read Only
%SR218	Number of Webpages, license detail			Read Only	Read Only
%SR219	Number of Data Points, license detail.			Read Only	Read Only
%SR220-222	Expiration Date of WebMI License, license detail			Read Only	Read Only

I/O Register Map for EXL6 & XL6 Prime

NOTE: These registers can be used as general purpose registers

Registers	Description					
	no I/O	102 I/O	103 I/O	104 I/O	105 I/O	106 I/O
%I1-%I12	Unused	Digital Inputs				
%I13-%I16	Unused	Reserved		Digital Inputs	Reserved	
%I17-%I24	Unused		Reserved	Digital Inputs	Reserved	
%I25-%I29	Unused		Reserved			
%I30 - %I131	Unused	PWM Table, see "High Speed I/O (HSC / PWM) " on page 95				
%I32	Unused		ESCP Alarm* (Electronic Short Circuit Protection)			
%Q1	Unused	PWM Table , see "High Speed I/O (HSC / PWM) " on page 95				
%Q2-%Q6	Digital Outputs					
%Q7-%Q12	Unused	Reserved	Digital Outputs			
%Q13-%Q16	Unused	Reserved		Digital Outputs	Reserved	
%Q17 - %Q20	HSC Table, see "High Speed I/O (HSC / PWM) " on page 95					
%Q21-%Q24	Reserved					
%AI1-%AI4	Unused	Analog Inputs	%AI1 - %AI2 for Analog Input Channels %AI3 - %AI4 - Unused			Mirror of first four analog channels
%AI33 - %AI38	Unused					Analog Inputs - for all 6 channels
%AQ1-%AQ8	Unused		PWM Table, see "High Speed I/O (HSC / PWM) " on page 95			
%AQ9-%AQ10	Unused			Analog Outputs		

*The ESCP bit is set high when the output current is too high, and the output driver has shut down for thermal protection. This typically happens when outputs are shorted, or they are driving loads that are higher than the output rating.

PWM Function Registers Map

Register	PWM	HSC	Stepper
%AQ1	PWM1 Duty Cycle (32-bit)	HSC1	Start Frequency
%AQ2		Preset Value	Run Frequency
%AQ3	PWM2 Duty Cycle (32-bit)	HSC2	Accel Count (32-bit)
%AQ4		Preset Value	
%AQ5	PWM Prescale (32-bit)	--	Run Count (32-bit)
%AQ6			
%AQ7	PWM Period (32-bit)	--	Decel Count (32-bit)
%AQ8			
%Q1	--	--	Run
%I30	--	--	Ready/Done
%I31			Error

HSC Functions Registers Map

Register	Frequency	Totalize	Pulse	Quad
%AI5-6		HSC1 (function) Accumulator		Quad 1 Acc
%AI7-8		HSC2 (function) Accumulator		
%AI9-10		HSC3 (function) Accumulator		Quad 2 Acc
%AI11-12		HSC4 (function) Accumulator		
%AQ1-2		HSC1 Preset		
%AQ3-4		HSC2 Preset		
%Q17		Clear HSC1		Clear Quad 1
%Q18		Clear HSC2		Set Quad 1
%Q19		Clear HSC3		Clear Quad 2
%Q20		Clear HSC4		Set Quad 2

EXL6 & XL6 Prime Resource Limits

Resource	Value
%S	13
%SR	192
%T	16000
%M	16000
%R	49999
%K	5
%D	1023
%I	2048
%Q	2048
%AI	512
%AQ	512
Ethernet	CsCAN, Ping, EGD, SRTP, Modbus TCP Master (Downloadable protocol) & Slave, Ethernet IP, FTP, or HTTP @ 10MBd or 100MBd
CsCAN	125kBd, 250kBd, 500kBd, or 1MBd
Serial Ports	1 RS-232, 1 RS-485 Ports
IDs Per CsCAN Network	64 w/o repeat (253 w/ 3 repeaters)
Keypad	5 keys (4 Function keys and a System Key)
Display	800 x 480 7" TFT, 65k colors
Screen Memory	64MB
User Screens	1023
Data Fields Per User Screen	1023
Ladder Code	1024kB

Cscape Configuration



Cscape Configuration

Cscape Status Bar	62
Establishing Communications	63
Cscape Configuration	71

Overview

EXL6/XL6 Prime OCS hardware is programmed with a Windows based PC application called Cscape. This application can be used to program, configure, monitor, and debug all aspects of the EXL6/XL6 Prime OCS unit. Please see the Online Help provided with Cscape for additional details.

Cscape Status Bar

When the EXL6/XL6 Prime OCS is connected to a PC using Cscape software, a Status Bar appears at the bottom of the screen. The Cscape Status Bar can be used to determine if communications have been established between the EXL6/XL6 Prime OCS and the Cscape program. Components of the Cscape Status Bar are explained below:

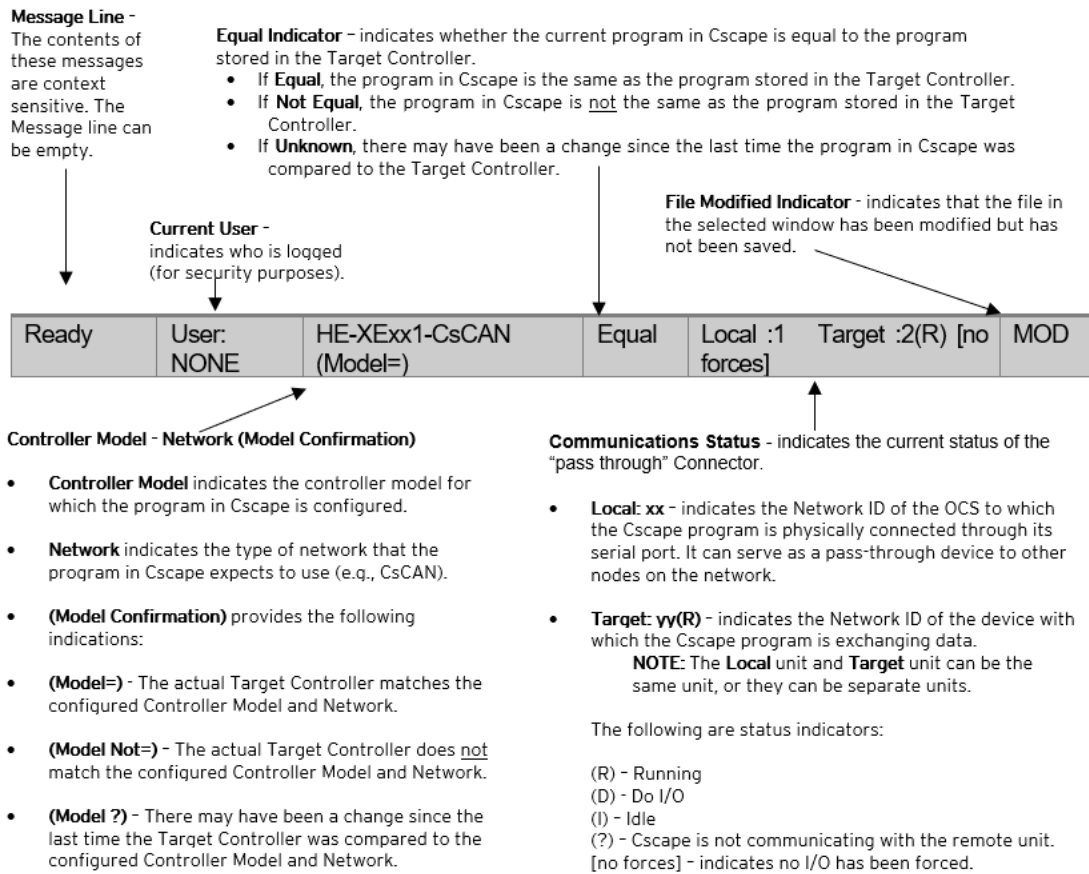

Establishing Communications

The EXL6/XL6 Prime OCS can communicate with Cscape using USB to USB, USB to serial adapters, serial port communications via MJ1 Port, Ethernet (with an Ethernet adapter board), onboard Ethernet Port, CAN (CsCAN), or modems.

If a direct USB connection is to be used, connect the Mini-USB port on the OCS (only on select models) to an open USB port on the PC. (A cable for doing this is included in [HE-CPK](#), the programming kits.) The OCS will install as a device once plugged in. Drivers for it are normally found automatically by the Windows operating system as long as an Internet connection is established.

See also the [Tools of the Trade](#) on the Horner website.

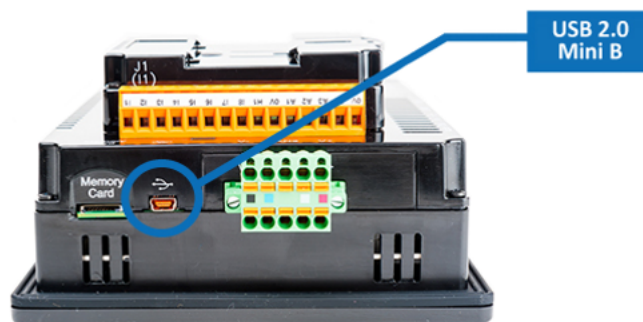

The PC will detect a new device has been plugged into the USB port.

Now that the EXL6/XL6 Prime is plugged in, go to **Cscape > Controller > Connection Wizard**. If you are just opening Cscape, Connection Wizard usually opens by default.

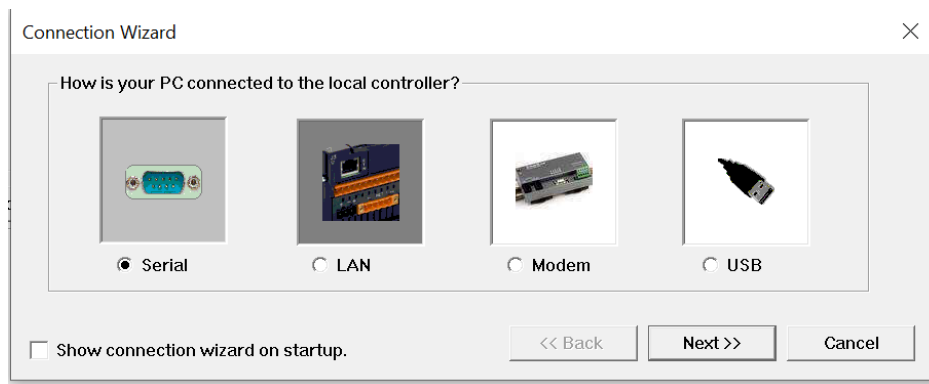

Select USB and click **Next >>**.

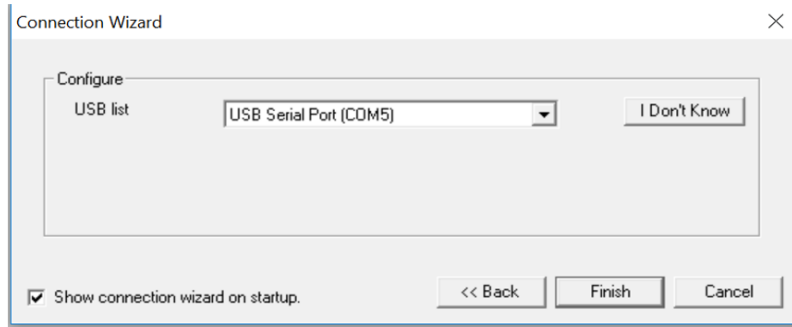

If the Connection Wizard does not pop up upon opening Cscape, then select **Controller** (in the Cscape tool bar) > **Connection Wizard**, choose your connection method. If you are connecting for the first time, we suggest connecting via USB.

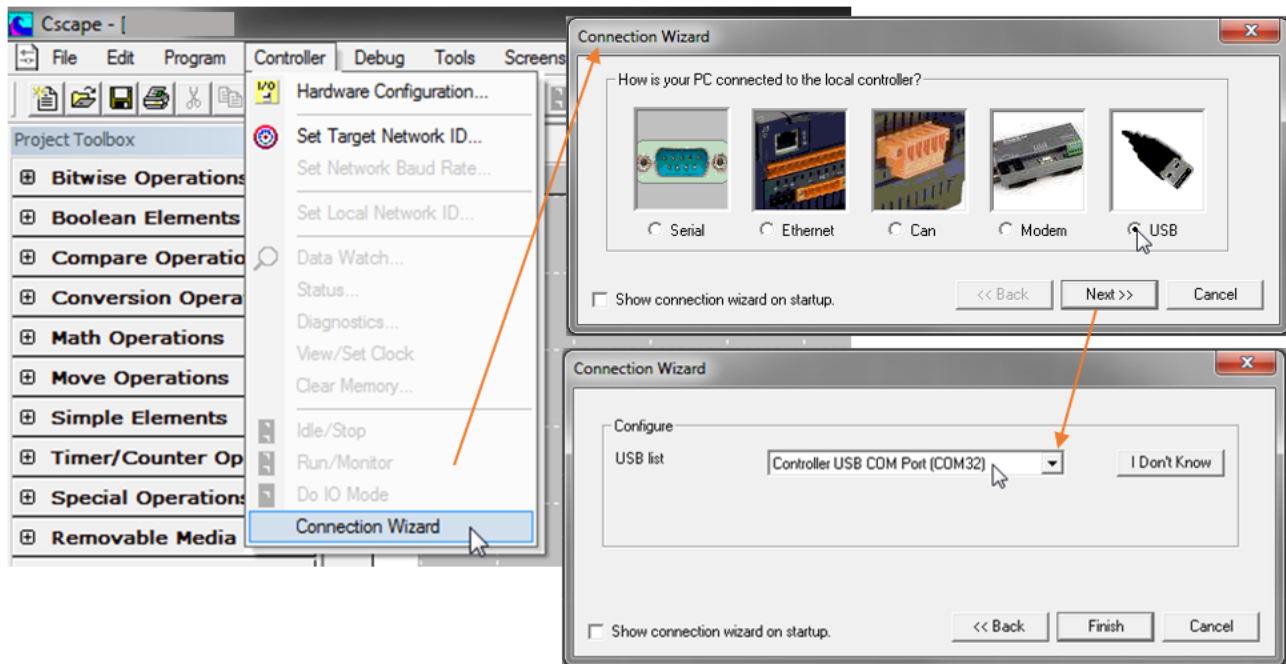

If **Controller USB COM Port** is not present in the dropdown list, the Windows operating system has not yet recognized the OCS as an installed device. Be sure the installation process is complete and that the correct drivers are installed. The Connection Wizard must be completely closed and reopened to refresh the USB dropdown list.

An alternate way to select the COM setting is to go to **Cscape > Tools > Application Settings > Communication > Configure** and choose connection method in **Add Target**.

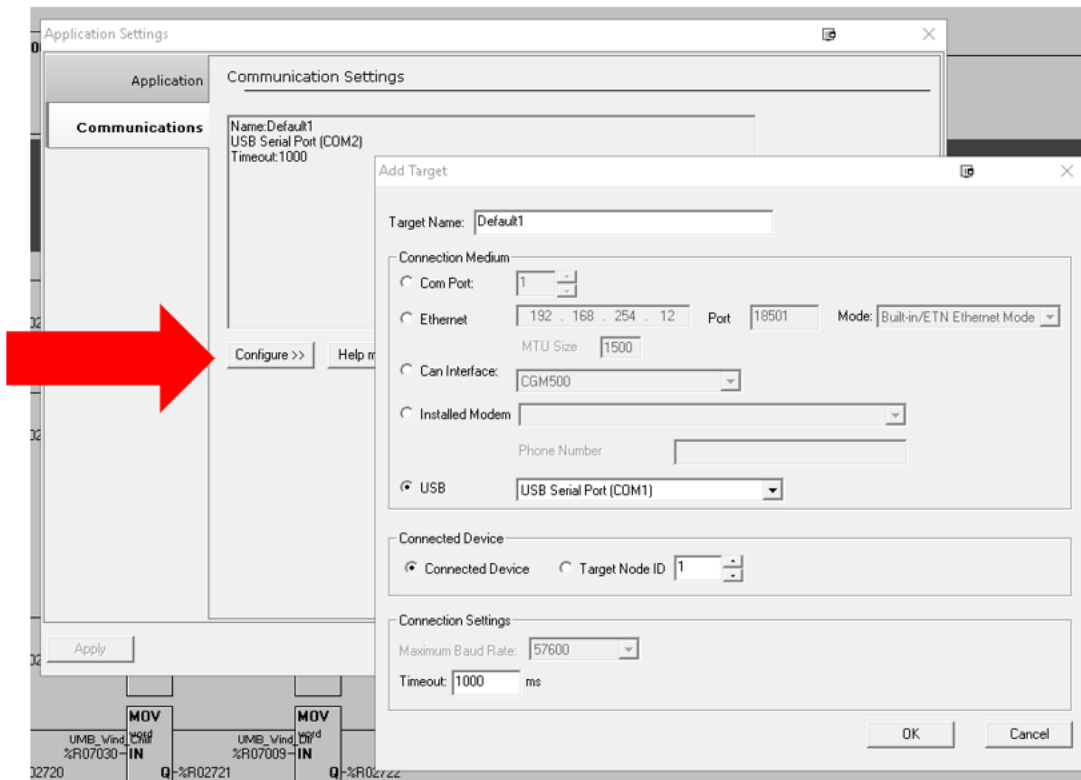
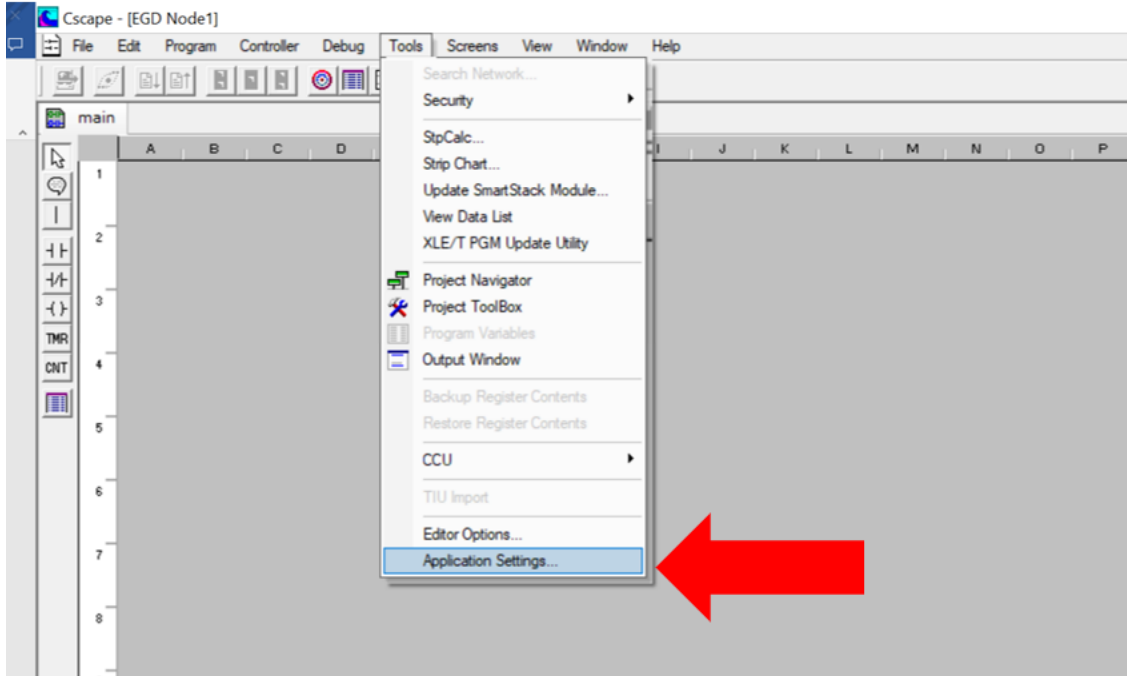

Communication Configuration Dialog	
Target Name	Name for connection. This is not a mandatory column to be filled, by default Cscape will populate 'Default1' in edit box.
Connection Medium	
Com Port	Select this option to communicate over serial communication with the device. The port number can be configured here.
Ethernet	<p>Select this option to communicate over Ethernet. Provide the IP address of the device and select the mode: HE GSM GPRS mode, Built in/ ETN Ethernet mode, or HE XEC Ethernet mode.</p> <p>Select HE GSM GPRS mode if communication with XL series controller on GPRS is required and the device has GSM modem installed in XL series controller. Select Built in/ ETN Ethernet mode if the device has on-board Ethernet port. Select HE XEC Ethernet mode if the device has Ethernet comm. option board installed in XL series controller.</p> <p>NOTE: For GPRS connectivity, GPRS configuration from Programs à Messaging à GPRS needs to be done.</p> <p>NOTE: The controller should support the type of connectivity selected and configured for Ethernet communication.</p>
CAN Interface	Select this option to communicate over CAN. This option requires additional hardware to be installed with the PC to be able to do so. Select the type of hardware installed from the drop-down.
Installed Modem	Select this option to communicate to the device through the internal modem of the computer. Cscape will automatically detect the internal modem attached with PC and list in the attached drop down. User can select modem and telephone number for target controller. NOTE: Cscape will do necessary initialization for the selected internal modem.
USB	Select this option to communicate over USB. Now Horner devices and Horner USB to serial converters are recognized and can be specifically selected.
Connected Device	
NOTE: This configuration is required if the controller to which Cscape is communicating is connected to a CsCAN network.	
Connected Device	By default, this option is selected and networking feature of Cscape is disabled.
Target Node ID	On selecting this option, Networking feature of Cscape is enabled. CsCAN ID for the target controller to be provide here.
Connection Settings (General Communication Settings)	
Maximum Baud Rate	Select the baud rate for serial communication.
Timeout	Select the communication timeout. NOTE: Select a larger timeout for GPRS and installed modem communication configuration

If communications are successful, the message line should show “USB (COM8)” for this example, and an (R) should follow the Target number.

USB (COM8) User: NONE XL4e - CsCAN Model Equal Not Equal Local:1 Target:1(R) [no forces]

When connected directly to the controller to which Cscape communications are required, the **Local ID and the Target ID should match.**

Local ID and Target ID Match

If the controller is not communicating, you may need to set the target ID of the controller in Cscape or on the unit. The Target ID allows directing communications to a particular unit when multiple units are connected via a CsCAN network. Units without CsCAN network ports respond to any network ID and do not require the ID to be configured.

To check or change the ID on the EXL6/XL6 Prime OCS, press the System Menu key.



The first item in the menu is Set Networks. Pressing Enter allows you to view or modify the ID of the unit.

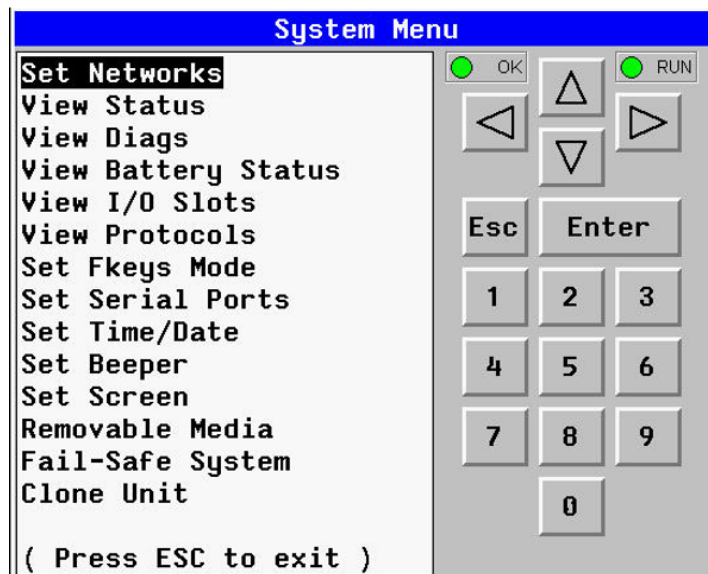

To change the Target ID of Cscape, highlight CAN ID and press **Enter** to provide a new number.

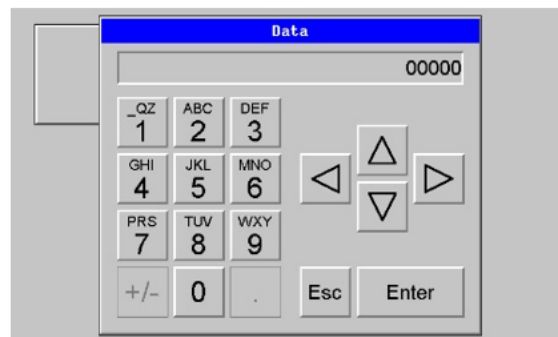

Communicating via MJ1 Serial Port

If a serial programming connection is to be used and the PC has a 9-pin serial COM port, which is increasingly rare, there is nothing to install assuming the port already works. All that is needed is a programming cable to go from the COM port to the OCS programming port.

If a serial programming connection is to be used and the PC does not have a COM port, a USB-to-Serial adapter may be used. Drivers for it are normally found automatically by the Windows operating system as long as an internet connection is established. Otherwise, the drivers may be loaded from the Horner FTP site at <https://hornerautomation.com/support-files>.

Connect the PC's serial port or the USB-to-Serial adaptor to the port labeled MJ1 on the EXL6/XL6 Prime.

The instructions are similar to using a USB port, as shown above. In the Connection Wizard, select the "Serial" option.

If communications are successful, the target indicator should show the mode of the controller Target: yy(R) as shown in the "Cscape Status Bar" on page 62.

If the controller is not communicating, you may need to set the **Target ID** of the controller in Cscape or on the unit. The **Target ID** allows directing communications to a particular unit when multiple units are connected via a CsCAN network. Units without CsCAN network ports respond to any network ID and do not require the ID to be configured.

To check or change the ID on the EXL6/XL6 Prime OCS, press the System Menu Key.

The first item in the menu is Set Networks. Pressing Enter allows you to view or modify the ID of the unit. Pressing Enter allows you to view or modify the ID of the unit.

To change the Target ID of Cscape use the **Controller > Set Target Network ID** dialog.

Communicating via On Board Ethernet Port

From Cscape go to **Controller > Hardware Configuration** and do auto configuration for the connected controller. Click on Config of Ethernet and select Module Setup.

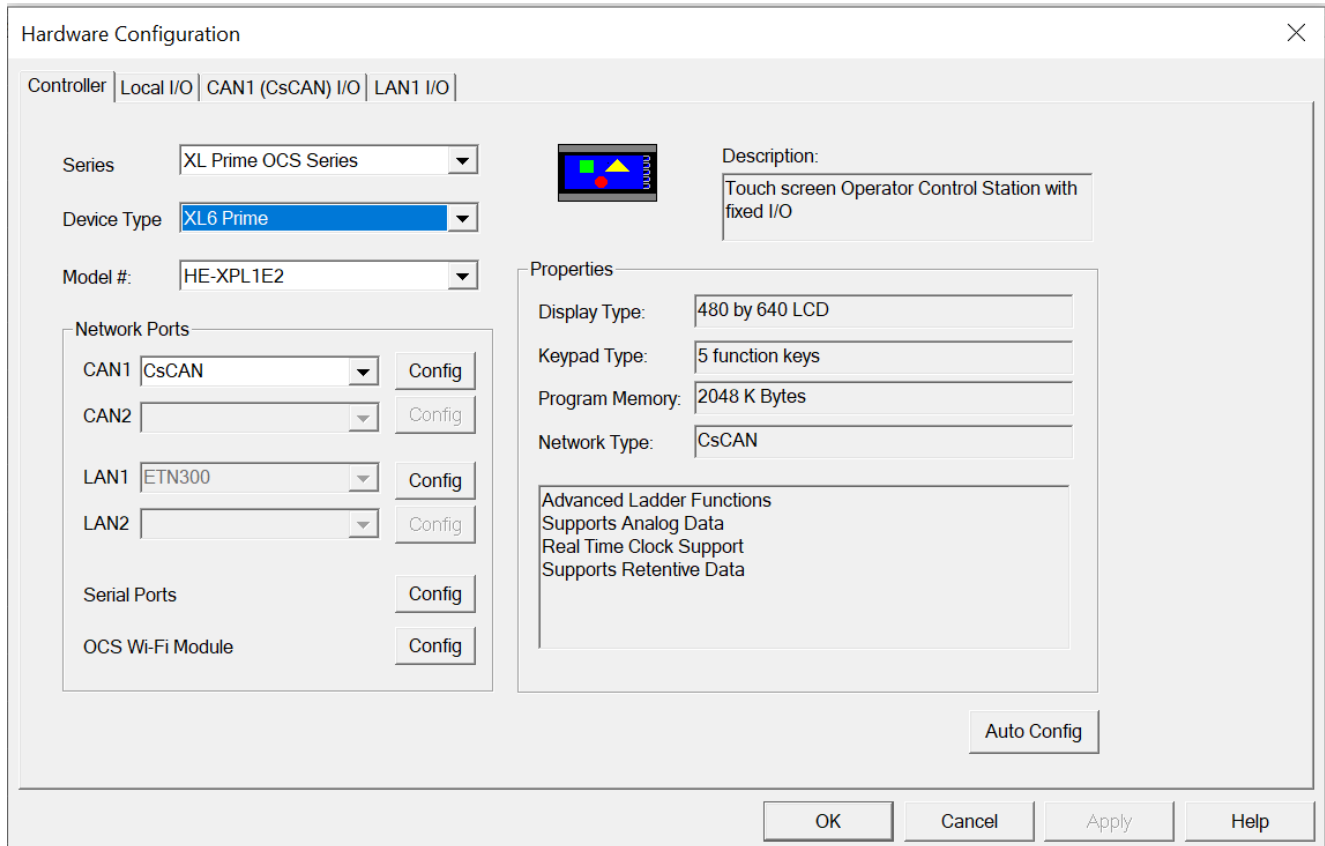

Hardware Configuration

Controller | Local I/O | CAN1 (CsCAN) I/O | LAN1 I/O

Series: XL Prime OCS Series

Device Type: XL6 Prime

Model #: HE-XPL1E2

Network Ports

- CAN1: CsCAN [Config]
- CAN2: [Config]
- LAN1: ETN300 [Config]
- LAN2: [Config]

Serial Ports [Config]

OCS Wi-Fi Module [Config]

Description: Touch screen Operator Control Station with fixed I/O

Properties

- Display Type: 480 by 640 LCD
- Keypad Type: 5 function keys
- Program Memory: 2048 K Bytes
- Network Type: CsCAN

Advanced Ladder Functions

- Supports Analog Data
- Real Time Clock Support
- Supports Retentive Data

Auto Config

OK Cancel Apply Help

The IP address, Net Mask, and Gateway of the controller may be temporarily set from the System Menu under the Set Networks menu item. Once running or power cycled the configuration will come from the Cscape configuration stored in the unit.

In Module configuration dialog, go to IP Address field enter unused IP Address and configure unused registers in Register field & then click OK. Screen shot for the same as follows:

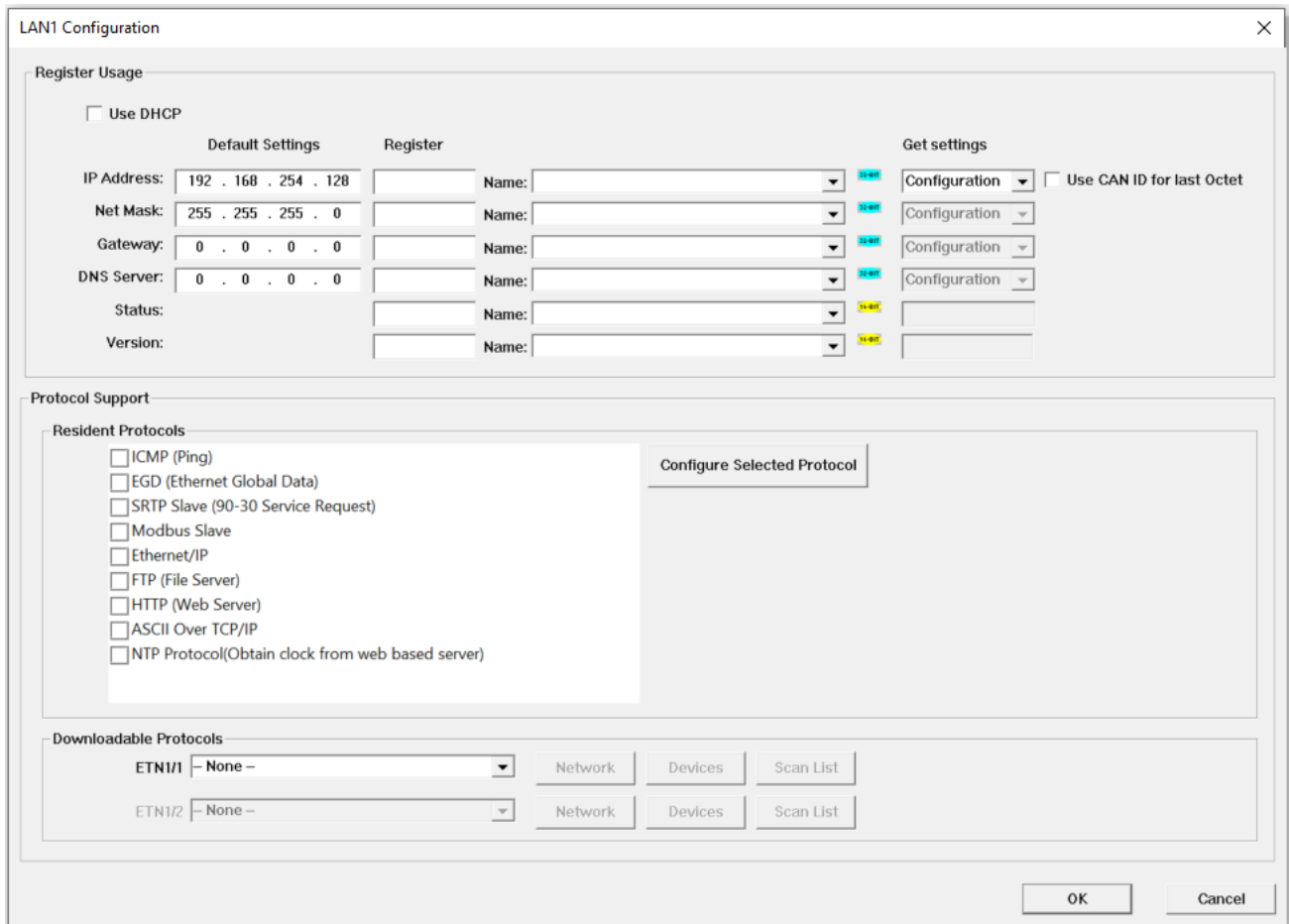

Download the configuration in to Controller. Connect LAN cable to the Controller in default LAN Port.

From Cscape go to **Tools > Editor Options > Communication Port > Configure**. Select Ethernet and enter IP address which is configured in the file. Select mode as XL Series mode from drop down list.

The controller should get connected to Cscape. If communications are successful, the target indicator should show the mode of the controller Target: yy(R) as shown in the as shown in the "Cscape Status Bar" on page 62 section.

Cescape Configuration

An overview of configuration:

1. Start the configuration by selecting the **Controller > Hardware Configuration** menu item.
2. If the EXL6/XL6 Prime OCS is connected to the PC, press the **Auto Config System** button to automatically detect the Base model, I/O, and any communication options.
3. If the EXL6/XL6 Prime OCS is not connected, press the Config button to the right of the top of the unit. This allows the base CPU to be selected.
4. Select either EXL6/XL6 Prime **OCS CsCAN** from the type drop down box.
5. Once the type of EXL6/XL6 Prime OCS is selected, the model # drop down box will provide the EXL6/XL6 Prime OCS model numbers from which to choose.
6. Once the EXL6/XL6 Prime OCS CPU is selected, press **OK** to exit the dialog and configure the I/O that is present in the first slot.
7. The I/O configure dialog (specifically the **Module Setup** tab) provides four (4) buttons to configure all of the I/O. Go through each area of I/O and configure it.
8. Once done configuring the I/O, OK out of configuration dialogs.

Configuring the EXL6/XL6 Prime OCS I/O has four main portions that are covered in this chapter. For additional information on I/O, refer to "General I/O Configuration" on page 1 or "High Speed I/O (HSC / PWM)" on page 95.

The four areas of Hardware configuration are Digital in / HSC, Digital out / PWM, Analog In, Analog Out.

General I/O Configuration



General I/O Configuration

Built-in Digital and Analog I/O Overview	73
Removing the Back Cover	74
Digital / HSC Input Configuration	75
Digital / PWM Output Configuration	79
Analog Inputs	84
Analog Outputs	93

Built-in Digital and Analog I/O Overview

The Horner OCS is a compact unit that contains high density and very versatile I/O. Using the I/O properly requires wiring to the proper terminals, configuring jumpers inside the Horner OCS unit and configuring Cscape properly. This section will offer some tips and suggestions to configure the I/O properly. For the register mapping of the I/O, refer to the "System Register Tables" on page 50 for more details.

Built-in Digital & Analog I/O								
Digital				Analog				
	DC In	DC Out (+)	Relay Out	HSC In*	Pulse Out**	mA/V In	mA/V RTD/TC (Universal)	mA/V Out
Model 2	12	--	6	4	--	4	--	--
Model 3	12	12		4	2	2	--	--
Model 4	24	16	--	4	2	2	--	--
Model 5	12	12	--	4	2	2		2
Model 6	12	12	--	4	2	--	6	4

*Shared with total DC inputs

**Shared with total DC outputs

For more details, see the controller datasheets via [Document Search](#).

Removing the Back Cover

WARNING: Power, including I/O power must be removed from the unit prior to removing the back cover. Failure to do so could result in electrocution and/or damage to equipment.

Some I/O configurations require jumper settings to be changed inside the Horner OCS unit. Examples of these settings are setting positive or negative logic on digital inputs or setting current or voltage on analog inputs.

Each Horner OCS I/O jumper is set to a factory default. Refer to the datasheet for a specific Horner OCS model to find the default setting to determine if a jumper change is necessary. Refer to Horner's [Documentation Search](#) page.

To remove the back cover of the Horner OCS, remove the four (4) Phillips screws from the back of the unit. It may help to place the Horner OCS unit face down on a clean work surface. Once the four screws are removed the back cover can be lifted straight off.

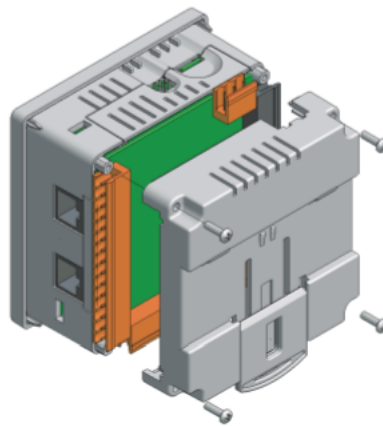

Once the back is removed the jumper selection can be changed. The jumper settings are documented on each data sheet using a diagram such as the figure below and a description of the jumper settings.

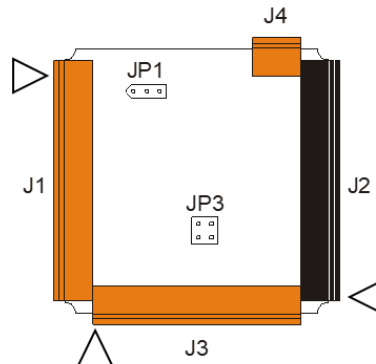

To re-install the back cover, place the cover back on the unit. The DIN clip should be on the same side as the power connector.

Place the screw back into the hole and turn the screw slowly counter clockwise until it clicks into the threads. This prevents the screw from being cross-threaded. Now turn the screw clock-wise until the cover is firmly secured. Repeat this process for all four (4) screws. Recommended torque is 3 - 4 in-lbs (0.34 – 0.45 Nm).

Digital / HSC Input Configuration

Horner controllers vary greatly on series and model numbers. Refer to the datasheets on the [Document Search](#) table on the Horner website.

The inputs are designed to support both positive and negative input modes. For many models, the mode is set by a jumper setting and a configuration parameter in Cscape. The Model 6 does not require jumpers, and only requires a configuration parameter in Cscape. All the inputs on the unit must be configured to the same mode.

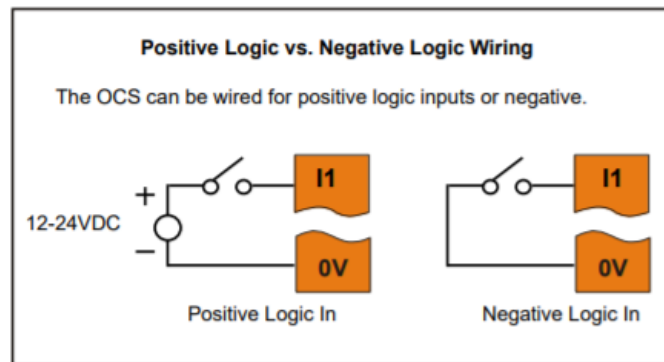

In positive logic mode a positive voltage applied to the input will turn the input. The internal design of this mode is basically a resistor from the input to I/O ground. This mode is sometimes called sourcing.

In negative logic mode, connecting the input to the I/O ground or zero volts will turn the input on. The internal design of this mode is basically a resistor from the input to the positive I/O voltage (usually 12 or 24V). This mode is sometimes called sinking.

Some of the digital inputs may support high-speed input functional such as counting or frequency measurement.

Digital Input Configuration

Home > Hardware Configuration [select Device Type/Model#] > Local I/O Tab > I/O / Config Button > Module Setup > Digital In/HSC

Select Hardware Configuration from the Home menu and ensure that the correct Device Type and Model# are selected. Then select the **Local I/O** tab.

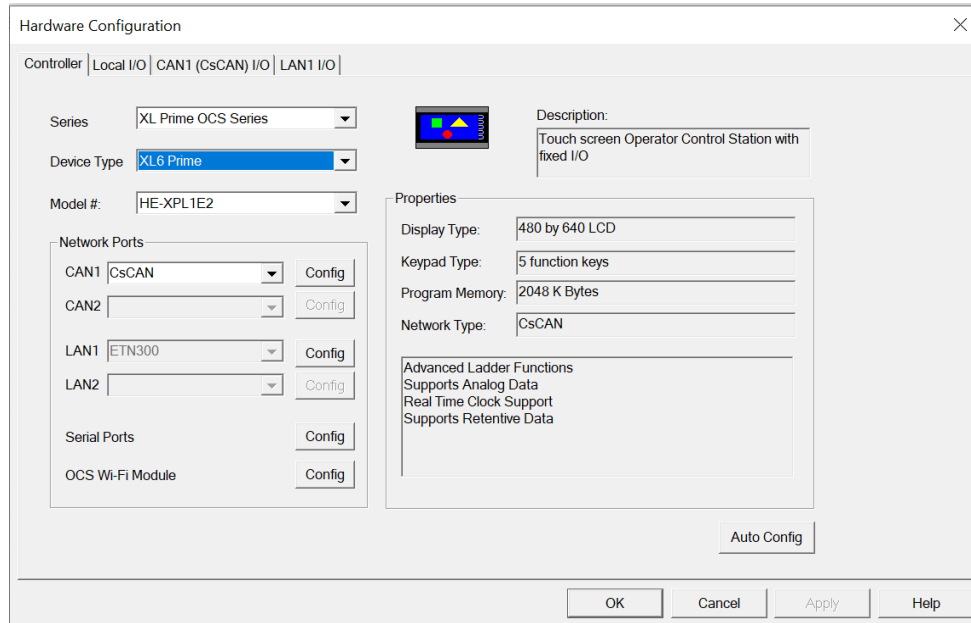

After selecting Local I/O, select the **Config** button next to the I/O connector.

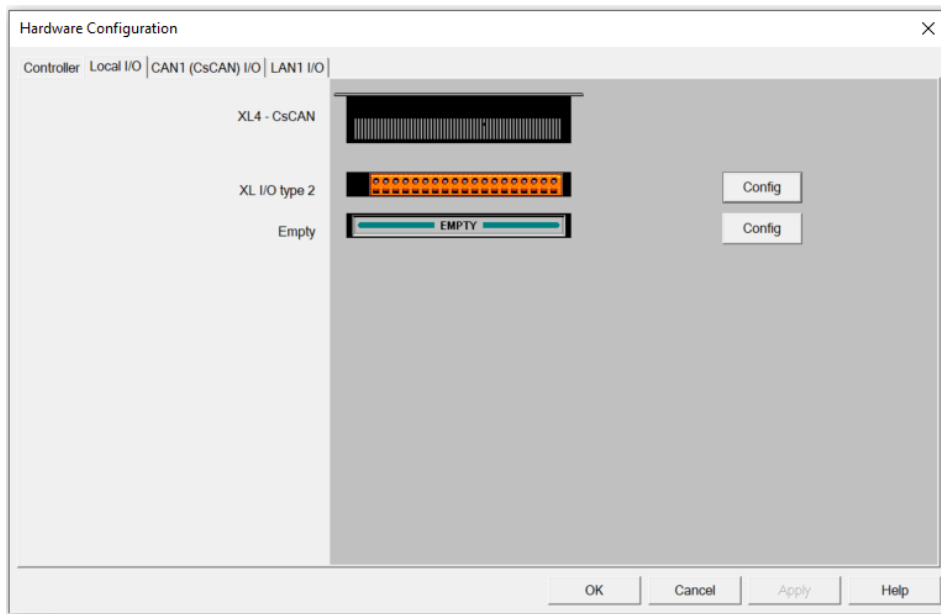

The **Module Configuration** screen will appear, select the **Module Setup** tab. See below.

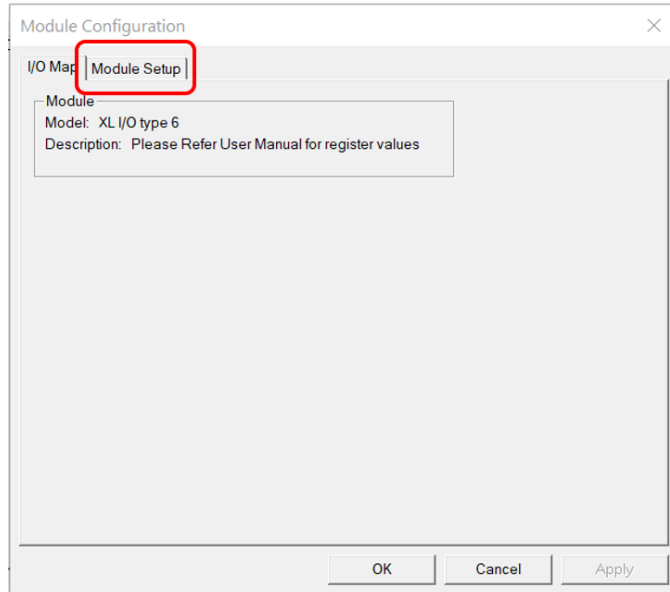

The Module Setup allows a user to configure four types of I/O. **NOTE:** Not all controllers offer all four types. Refer to the controller's datasheet on the using Horner's [Documentation Search](#) page.

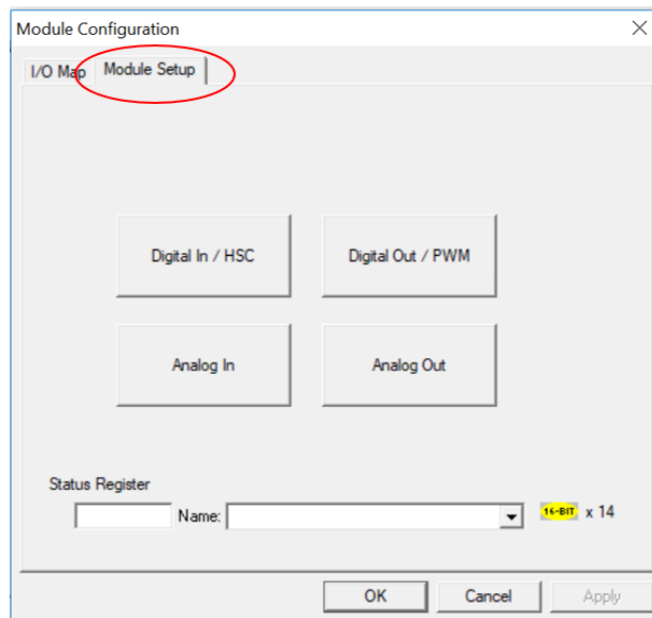

Select **Digital In/HSC** to open the Digital / HSC Input configuration dialog for a specific controller.

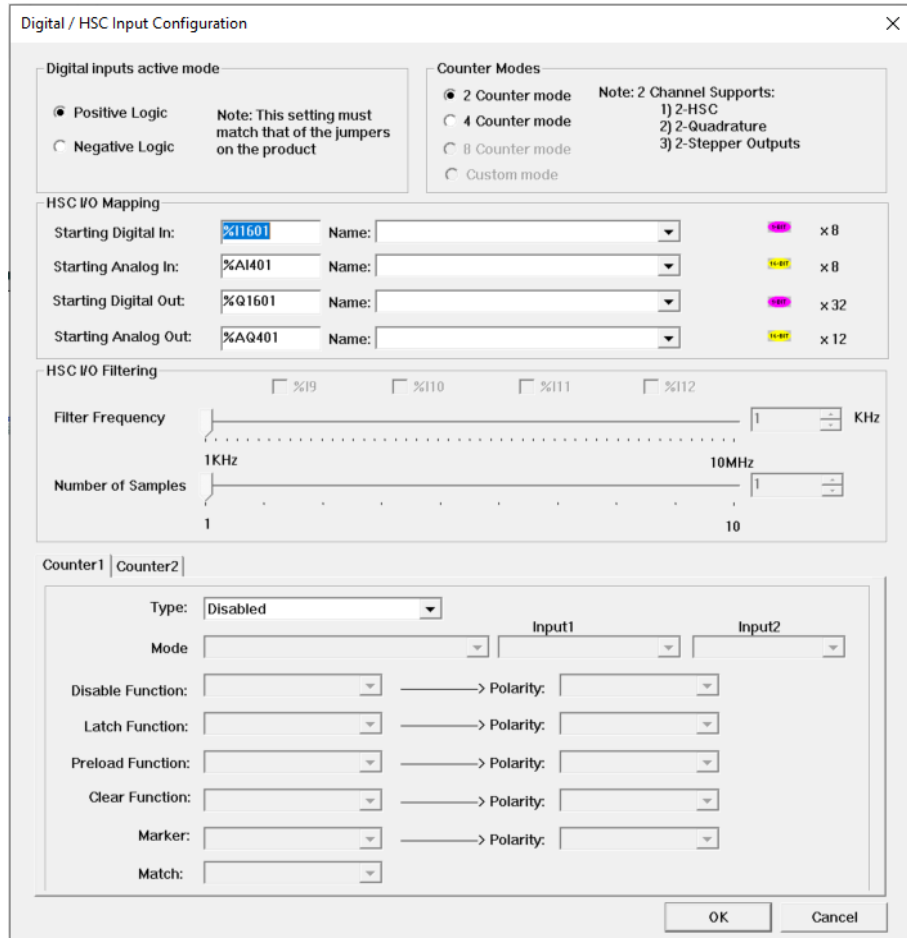

The Active mode group box allows the user to select if inputs are active high (Positive logic) or active low (Negative logic). It is important that this setting matches the jumper settings on the hardware.

The High-Speed Counters group box contains all the windows that are used to configure the four available high-speed counters on the Horner OCS. To configure a counter, the user needs to set the type, mode, and counts per rev.

The type drop down includes the following options:

- Disabled
- Frequency
- Totalize
- Pulse
- Quadrature
- Marker (Only available in counter #3 if counter #1 is set to quadrature.)

The mode drop-down items are set according to the type selection. The Counts Per Rev. window is enabled/disabled according to the type selection as well.

Digital / PWM Output Configuration

Solid State Digital Outputs

Solid-state digital outputs are generally used to activate lamps, low voltage solenoids, relays, and other low voltage and low current devices.

NOTE: The digital outputs used on some controllers are sourcing outputs. This means the output applies a positive voltage to the output pin when turned ON. When turned off, the output applies approximately zero volts with respect to the I/O ground. Use the Documentation Page to view the datasheet for a specific controller for specifics on a module's I/O.

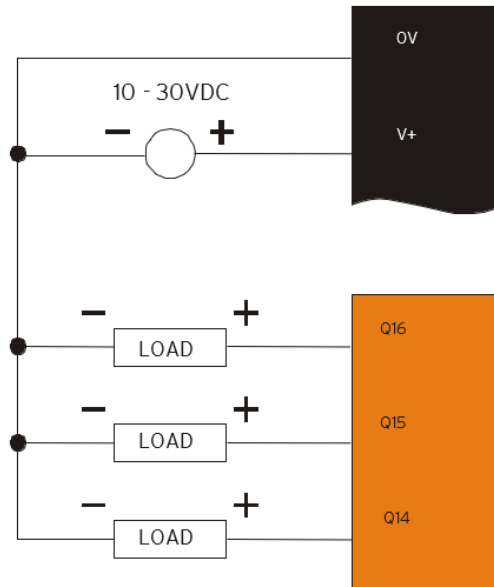

The digital outputs used in the OCS have electronic short circuit protection and current limiting. While these electronic protections work in most applications, some application may require external fusing on these outputs.

The digital outputs in the OCS are typically controlled via %Q bits in the register mapping. Some of the outputs are designed for high-speed applications and can be used for PWM or frequency output applications.

When the controller is stopped, the operation of each output is configurable. The outputs can hold the state they were in before the controller stopped or they can go to a predetermined state. By default, digital outputs turn off.

NOTE: The digital outputs feature an output fault bit. %I32 will turn on if any of the outputs experience a short circuit, over-current or the output driver overheats.

Relay Outputs

Relay outputs are designed to switch loads that typically have high voltage or current requirements or require the isolation that relays provide. Relay outputs are not available on all controllers, see the datasheet. **NOTE:** The design of the OCS does not require external coil power for the relays to function. The relays will activate anytime the OCS is powered. There are several factors that should be considered when using relays:

- **Relay Life** – Relays are mechanical devices that have a long but limited life. Typically, switching more current limits the life of relays. Please check the data sheets at the end of this manual for expected relay life.
- **Current / Temperature De-Rating** – Products containing relays often have total current limits based on the ambient temperature of the application. Please see the product data sheet for current / temperature de-rating information for relays.
- **Fusing** – External fusing is generally required to protect the relays, devices and wiring from shorts or overloads.

WARNING: To protect the module and associated wiring from load faults, use external (5A) fuse(s) as shown. Fuses of lower current or fusing for the entire system need to be in place to assure the maximum current rating of the unit is not exceeded.

WARNING: Connecting high voltage to any I/O pin can cause high voltage to appear at other I/O pins.

Below is an example of Relay Fusing:

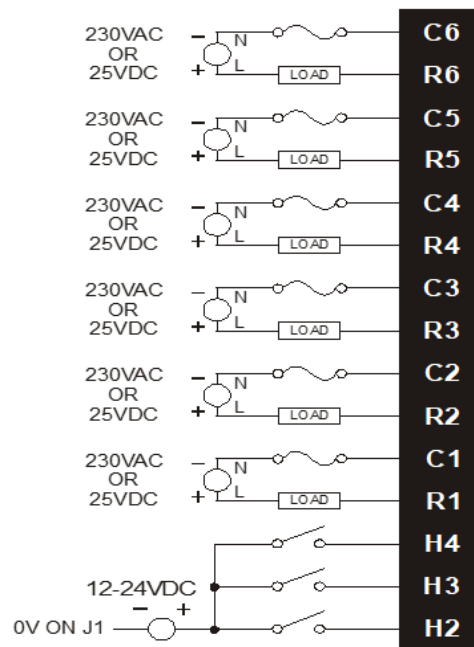

Protection for Inductive Loads - Inductive loads can cause reverse currents when they shut off that can shorten the life of relay contacts. Some protective measures need to be determined by an engineer. Below you will find recommendations that will work for many applications. If you have additional questions on protection from inductive load, consult an application engineer or Horner Technical Support. Details on devices that may protect outputs can be found in the [Spark Quencher Datasheet](#), MAN0962, which is located on the website.

Output State on Controller Stop - When the controller is stopped, the operation of each output is configurable. The outputs can hold the state they were in before the controller stopped or they can go to a predetermined state. By default, relay outputs turn off.

Digital Output Configuration

Home > Hardware Configuration [select Device Type/Model#] > Local I/O Tab > I/O / Config Button > Module Setup > Digital Out/PWM

Select Hardware Configuration from the Home menu and ensure that the correct Device Type and Model# are selected. Then select the **Local I/O** tab.

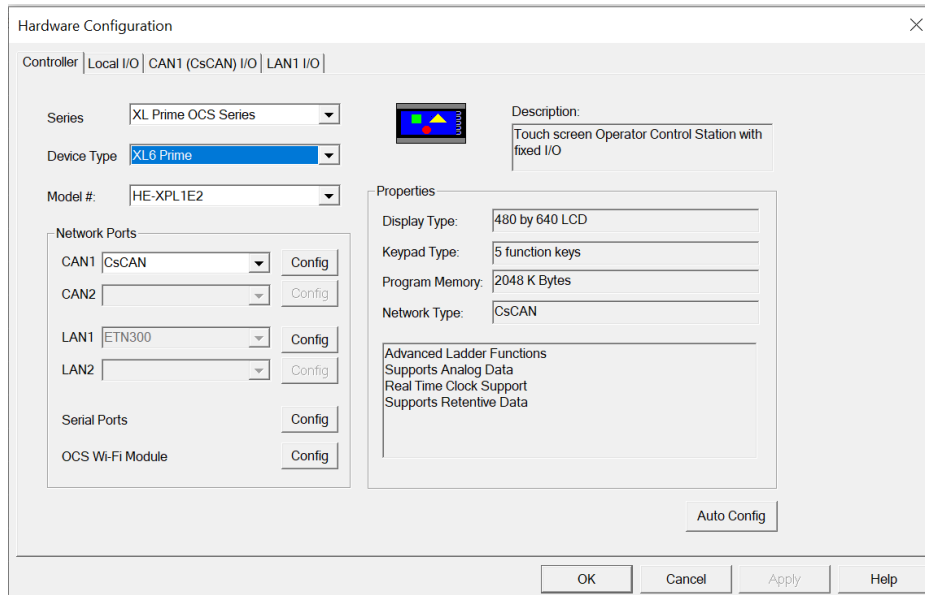

After selecting Local I/O, select the **Config** button next to the I/O connector.

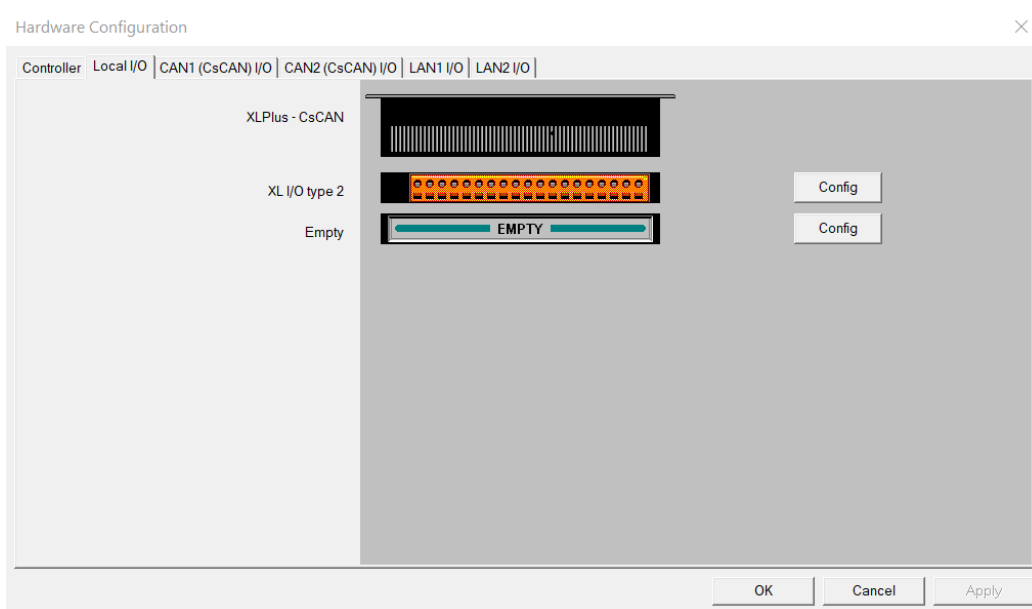

The **Module Configuration** screen will appear, select the **Module Setup** tab. See below.

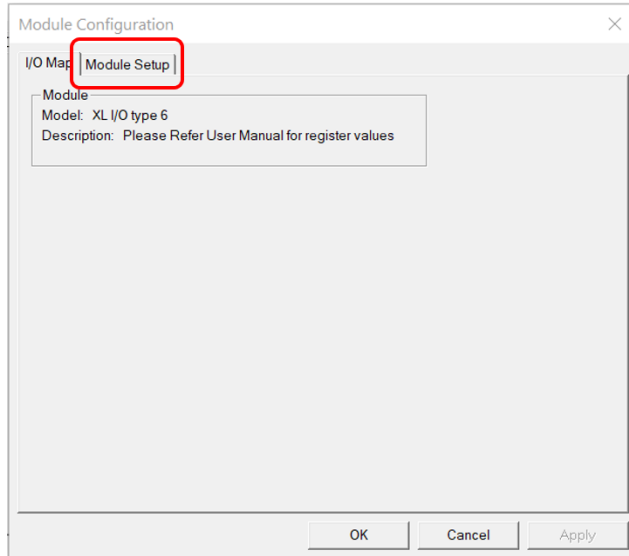

The Module Setup allows a user to configure four types of I/O. **NOTE:** Not all controllers offer all four types. Refer to the controller's datasheet the using Horner's [Documentation Search](#) page.

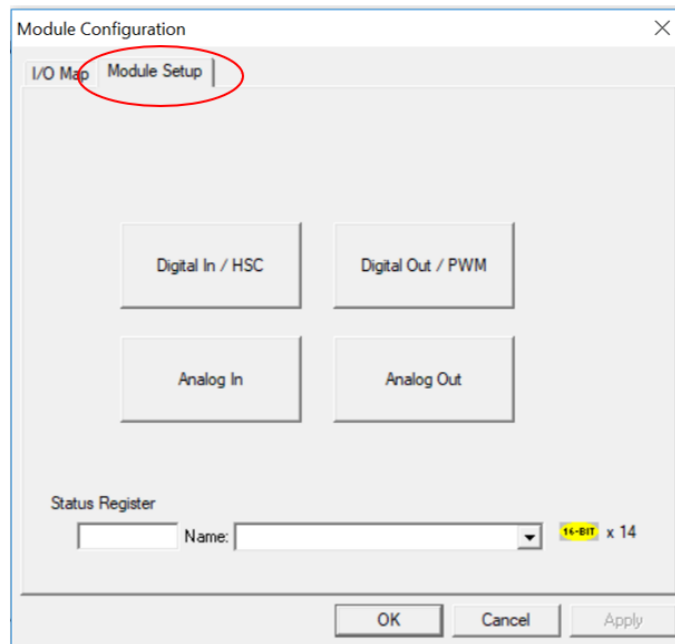

Select **Digital Out/PWM** to open the **Digital / PWM Output Configuration** dialogue.

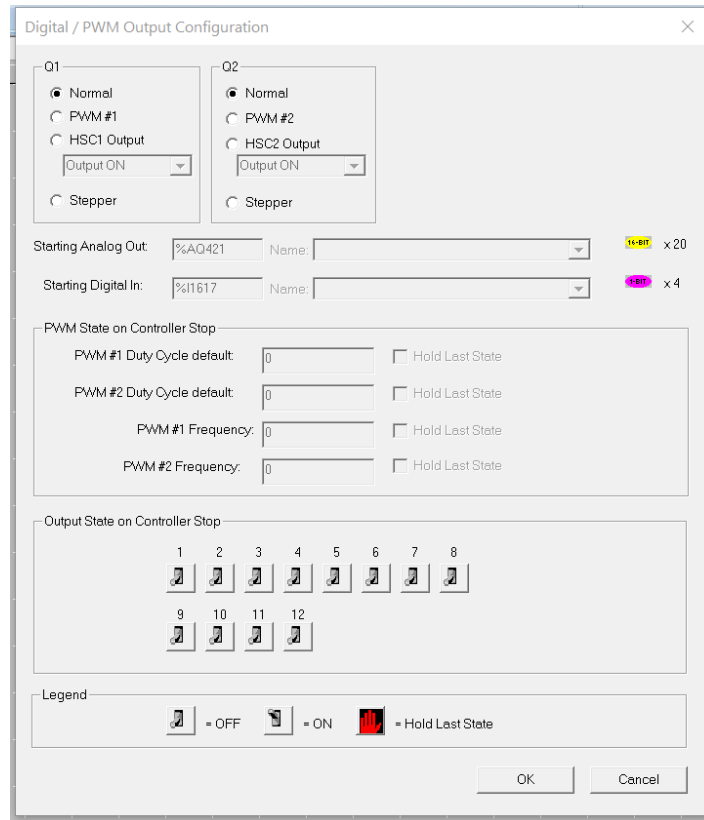

The **Q1** and **Q2** group boxes allow the user to specify the operation of the multifunction outputs.

PWM State On Controller Stop - Contains items that allow the user to specify how the PWM outputs behave when the controller is stopped. These items can either hold their value or default to some value when the controller is stopped.

NOTE: The PWM outputs are set to the OFF state at power-up and during program download and remain in that state until the unit is placed in RUN.

Output State On Controller Stop - Contains items to allow the user to specify how the remaining digital outputs behave when the controller is stopped. These items can either hold their value or default to some value when the controller is stopped. **NOTE:** The number of Output States on Controller Stop vary by product.

Stop State - When a controller stops running ladder logic, the state of most output I/O modules can be configured. By default digital outputs turn OFF and analog outputs go to a zero output level. Outputs can be configured to hold the last state the outputs was in when the controller stopped, or it can be configured to go to a predefined state.

NOTE: When a controller is in DO I/O mode the outputs are still controlled by the values in the controller's registers.

NOTE: The number of Output State on Controller Stop varies by controller. See the datasheet on the Documentation Page for more details.

Analog Inputs

The analog inputs on the OCS allow voltage or current measurement from a variety of devices. The voltage or current mode is set through jumpers on the unit and settings in Cscope. Each channel can be separately configured for voltage or current mode.

The analog inputs have a digital filter that can be used to filter electrical noise that may be unavoidable in some installations. The downside to digital filtering is the inputs will respond more slowly to sudden changes in the actual input.

Home > Hardware Configuration [select Device Type/Model#] > Local I/O Tab > I/O / Config Button > Module Setup > Analog In

Select Hardware Configuration from the Home menu and ensure that the correct Device Type and Model# are selected. Then select the **Local I/O** tab.

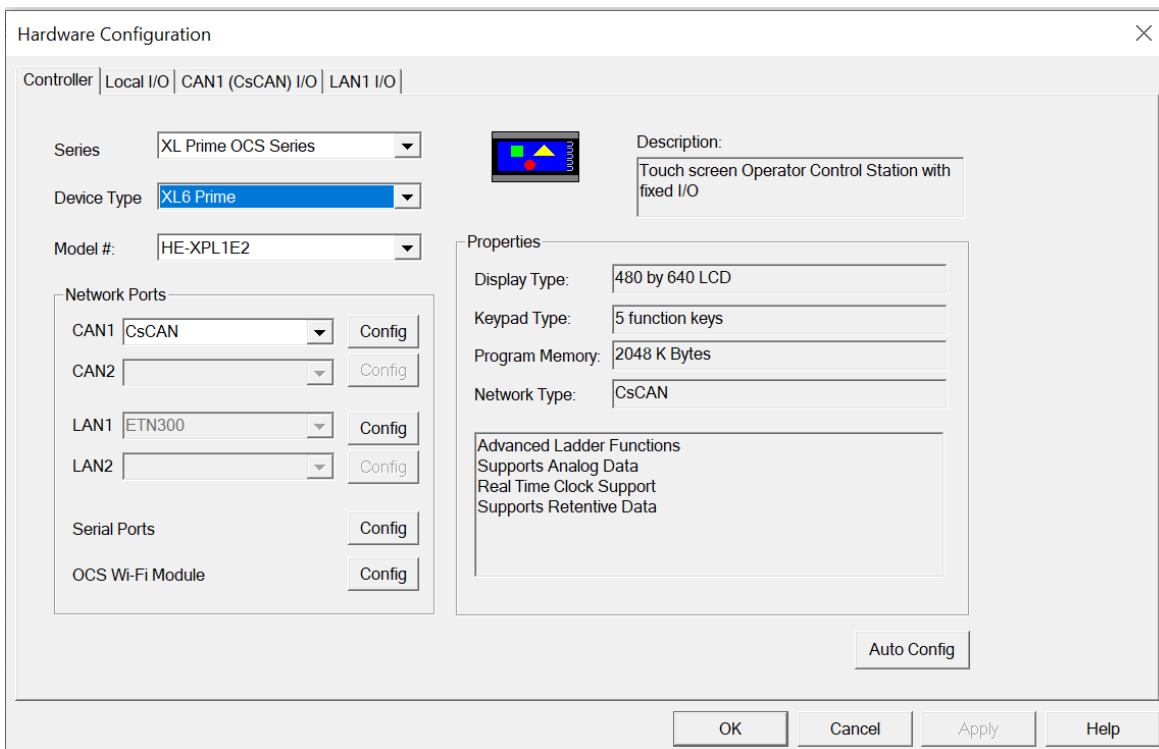

After selecting Local I/O, select the **Config** button next to the I/O connector.

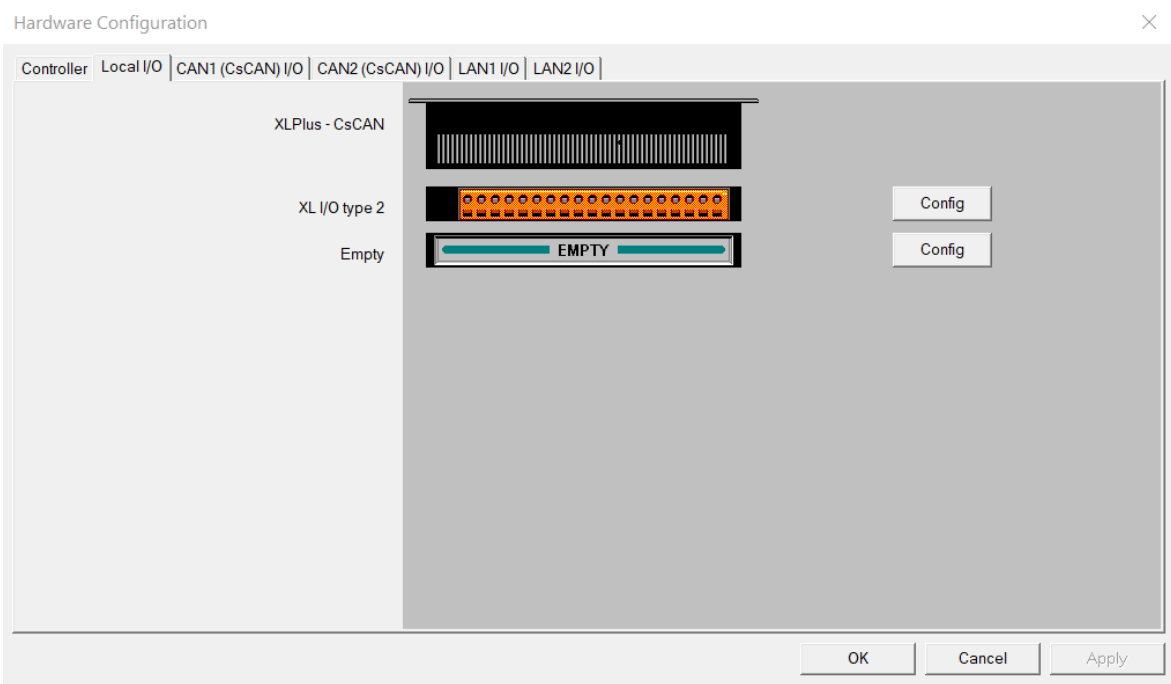

The **Module Configuration** screen will appear, select the **Module Setup** tab. See below.

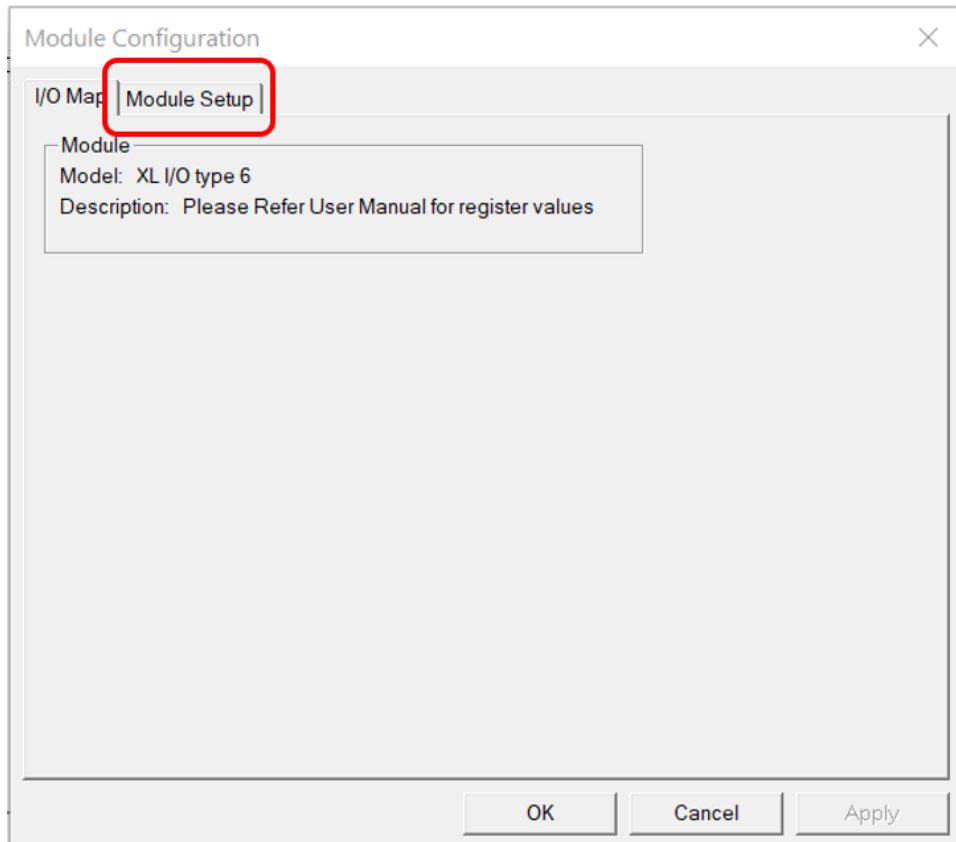

The Module Setup allows a user to configure four types of I/O. **NOTE:** Not all controllers offer all four types. Refer to the controller's datasheet on the Horner website's Documentation Page for more information regarding specific models.

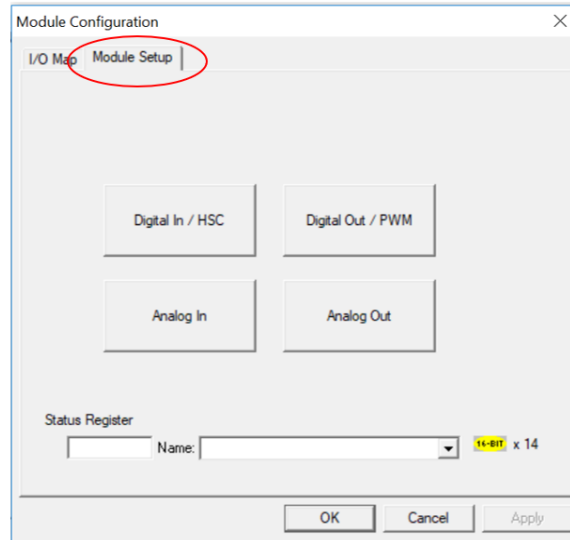

Select **Analog In** to open the **Analog Input Configuration** dialogue:

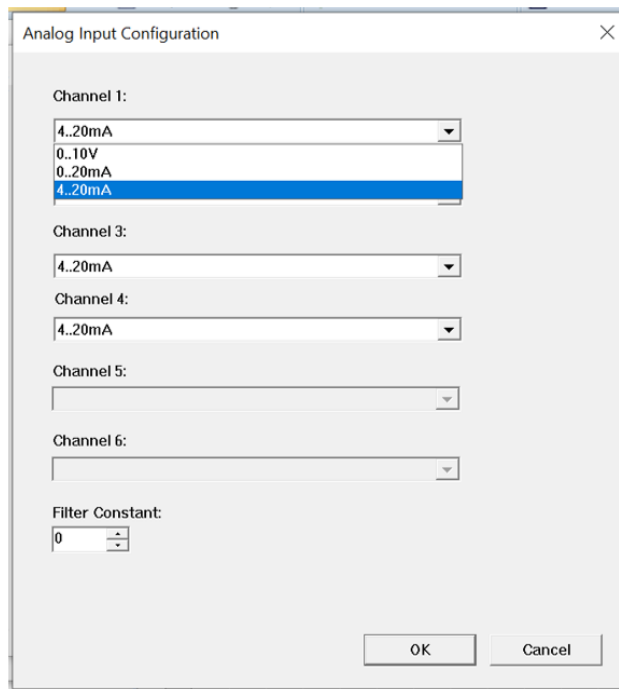

The Channel x drop down windows allow the user to specify the mode for each analog input to operate. The Channel x drop down windows are enabled/disabled according to which model is being configured. All of the models have the following modes available: 0..10V, 0..20mA & 4..20mA.

On the XL series, the Model 5 and Model 6 modules have more channel options.

Universal Analog Inputs Model 5

The universal analog inputs provide a high resolution, very flexible interface for a variety of analog inputs. These inputs include voltage, current, thermocouple, RTD, and millivolt. Each channel can be configured separately using jumpers and configuration settings in Cscope.

Like the standard analog inputs, these inputs have a digital filter that can be used to filter electrical noise that may be unavoidable in some installations. The downside to digital filtering is the inputs will respond more slowly to sudden changes in the actual input.

Analog In for Model 5
Channels 1 & 2
0..10V
0..20mA
4..20mA
100mV
PT100 DIN RTD, 1/20°C
Type J Thermocouple, 1/20°C
Type K Thermocouple, 1/20°C
Type N Thermocouple, 1/20°C
Type T Thermocouple, 1/20°C
Type E Thermocouple, 1/20°C
Type R Thermocouple, 1/20°C
Type S Thermocouple, 1/20°C
Type B Thermocouple, 1/20°C
* The Filter Constant provides filtering to all channels.

Model 5 Universal Analog Input Configuration

1. Select Analog In to access the Analog Input Configuration menu.
2. Select any of the Analog input types from the drop-downs by clicking the down arrow beneath each corresponding Channel, as seen below:

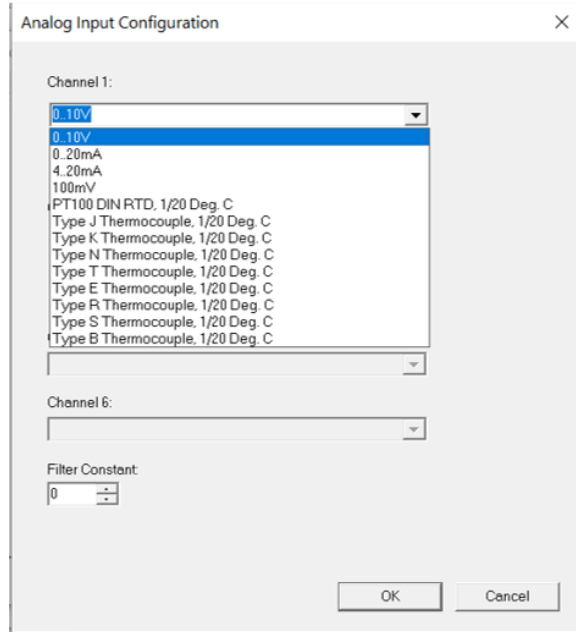

3. Ensure the proper wiring is used for each of the pins on the Universal Analog Inputs as seen in the image and table below:

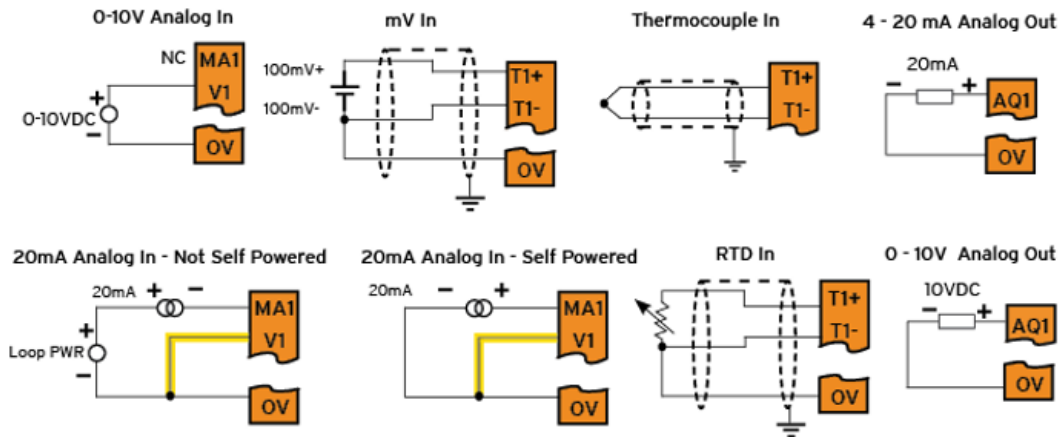

Table for Model 5 Universal Wiring

J3 Connector for Universal Wiring	
T1+	TC (1+) or RTD (1+) or 100mV (1+)
T1-	TC (1-) or RTD (1-) or 100mV (1-)
T2+	TC (2+) or RTD (2+) or 100mV (2+)
T2-	TC (2-) or RTD (2-) or 100mV (2-)
AQ1	10V or 20mA OUT (1)
AQ2	10V or 20mA OUT (2)
0V	Common
MA1	0-20mA IN (1)
V1	0-10V IN (1)
0V	Common
MA2	0-20mA IN (2)
V2	0-10V IN (2)
0V	Common

Universal Analog Inputs Model 6

The Universal Analog Inputs on the Model 6 IO board are unique from other Horner XL-series input/output cards in that they are configurable through the module configuration instead of having to change jumper settings in order to setup the input type.

Analog In for Model 6
Channels 1-6
0..10V
0..20mA
4..20mA
Disable
0-60mV
PT100 DIN RTD, 1/10°C
PT1000 DIN RTD, 1/10°C
Type J Thermocouple, 1/10°C
Type K Thermocouple, 1/10°C
Type N Thermocouple, 1/10°C
Type T Thermocouple, 1/10°C
Type E Thermocouple, 1/10°C
Type R Thermocouple, 1/10°C
Type S Thermocouple, 1/10°C
Type B Thermocouple, 1/10°C

Model 6 Universal Analog Input Type Configuration

1. Select Analog In to access the Analog Input Configuration menu.
2. Select any of the Analog input types from the drop-downs by clicking the down arrow beneath each corresponding Channel, as seen below:

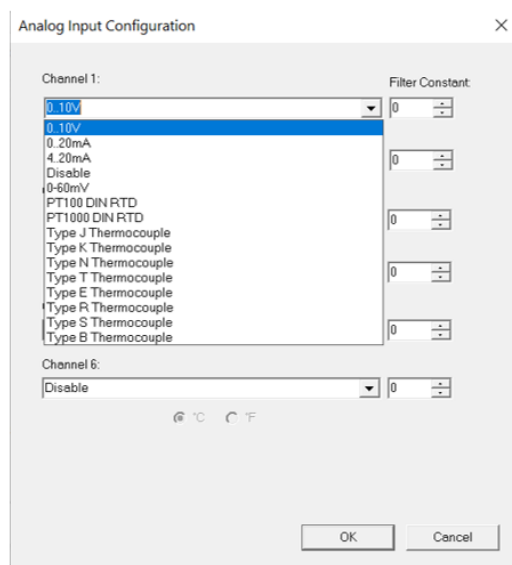

- Ensure the proper wiring is used for each of the 3 pins A , B, and C on the Universal Analog Inputs as seen in the reference image below:

EX: Universal Input Wiring Schematic

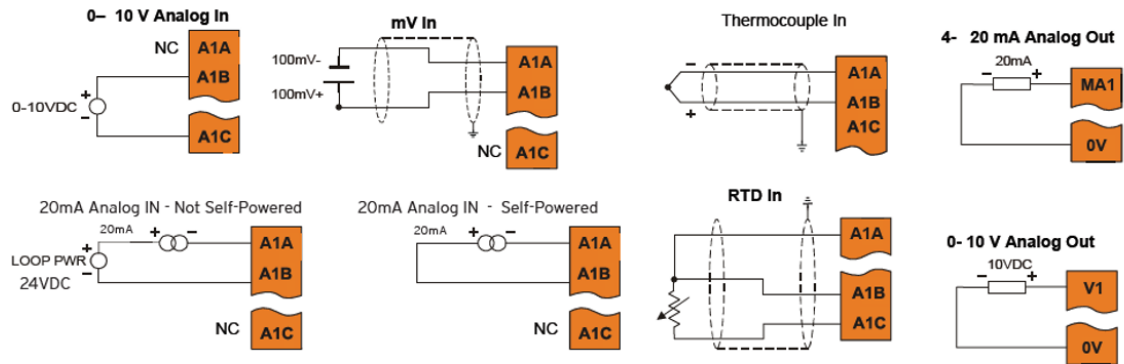

NOTE: Depending on the transmitter, isolated loop power may be required.

Scaling Analog Inputs & Examples

To access the Advanced Math Scaling function, select **Home > View > Project Toolbox**. This will open a side bar, and then select **Advanced Math > Scale**.

Example 1

The Cscape Scale function, found in the Advanced Math functions, allows for very easy conversion of the raw input value into a meaningful reading. For example, a pressure transducer may be specified as a 4-20mA signal to signify a 0-2000 psi pressure reading. With the analog channel set to the 4..20mA range, the raw analog input value, which is in INT format ranges from 0 to 4mA to 32000 for 20mA. Use the Scale function to obtain an Integer pressure reading using the 0-32000 raw input range and the sensor's 0-2000psi output range.

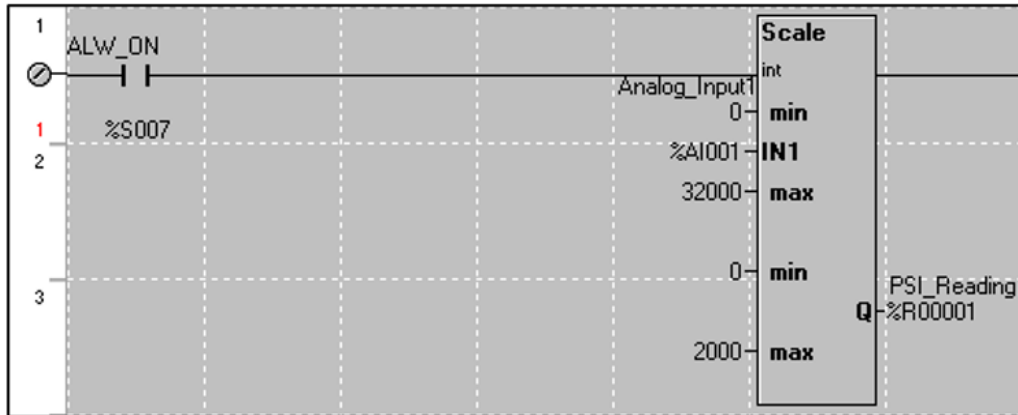

Example 2:

If readings with fractions are required, the raw Integer input value must first be translated in REAL, or Floating Point Format, see note below. . The Cscape INT-to-REAL Conversion function may be used to convert the raw input value from INT to REAL format in an intermediate memory location. The SCALE function, specified as REAL type, may be used to scale the converted raw value into a reading that supports digits beyond the decimal place, i.e. 475.25psi.

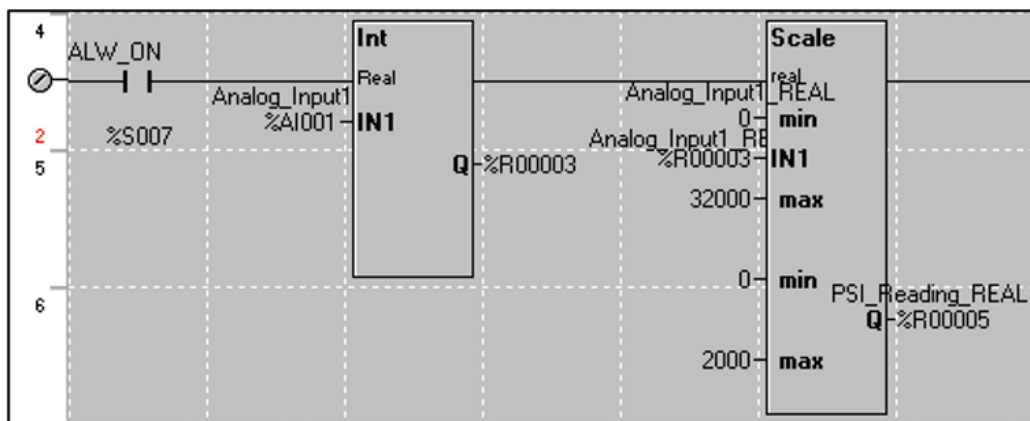

Analog Outputs

NOTE: Refer to the datasheet for details on jumper settings.

The analog outputs on Horner OCS devices provide high resolution voltage or current outputs. The voltage or current selection is controlled with jumpers and configuration settings in Cscape.

NOTE: Each channel can be separately configured for voltage or current mode.

When the controller is stopped, the operation of each output is configurable. The outputs can hold the state they were in before the controller stopped or they can go to a predetermined value. By default, analog outputs are set to a value of zero (0).

The following figure illustrates the Analog Output Configuration dialog. To open the I/O configuration dialogs, select **Controller > Hardware Configuration > Local I/O > Config > Module Setup**.

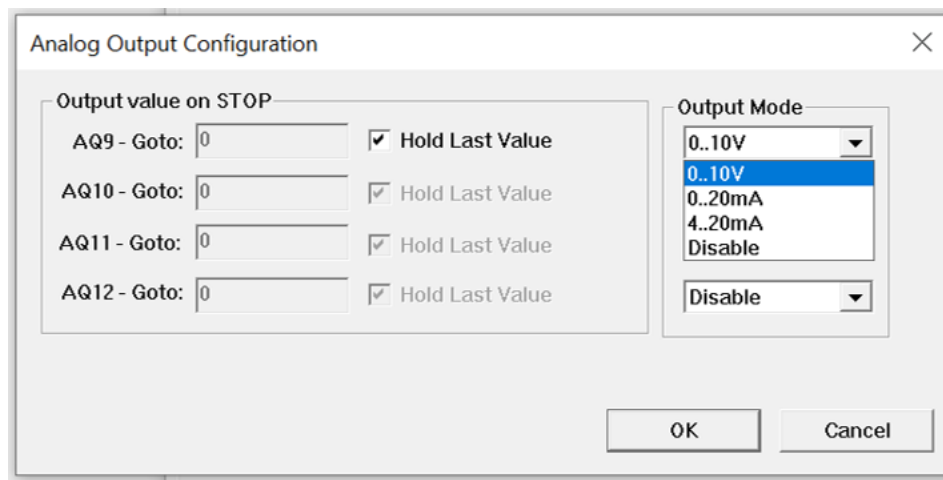

The Output value on Stop group box contains items that allow the user to specify how the analog output channels behave when the controller is stopped. The outputs can either hold their value or default to a value when the controller is stopped.

The Output Mode group box allows the user to select the operating modes for each of the analog outputs. The modes include the following:

- 0..10V
- 0..20mA
- 4..20mA

For more information on Stop State, refer to the "Cscape Configuration" on page 62.

High Speed I/O (HSC & PWM)



High Speed I/O (HSC / PWM)

Overview	95
High Speed I/O Glossary	96
High Speed Counter (HSC) Functions	97
HSC Functions	102
HSC Functions Register Maps	104
High Speed Output Functions	108
High Speed Output Functions Register Map	111
HSC I/O Filtering	114

Overview

In addition to the compliment of simple analog and digital I/O, several of the OCS I/O modules support High Speed Counting (HSC) I/O functions and may also support Pulse Width Modulation (PWM) Output functions (non-relay modules). The HSC functions include internal timing, frequency, totalizing, pulse width/period, and quadrature measurement. The PWM functions include traditional PWM (with variable rate and duty cycle) and a stepper (limited functionality) with variable acceleration and deceleration rates.

The OCS contains a **Field-Programmable Gate Array (FPGA)**, which is an integrated configurable circuit that allows the OCS to be programmed to have either two high-speed counters or four high-speed counters. The OCS ships with two high-speed counters, but a customer can contact Horner Technical Support to receive a file that will configure the unit to have four. These modes are not supported simultaneously. Two counter mode supports Quadrature mode and two stepper outputs, while four counter mode does not support Quadrature mode and supports only one stepper output.

This chapter describes the operation of these high level I/O functions. For configuration details of these functions, see "Cscape Configuration" on page 1.

High Speed I/O Glossary

Glossary of High Speed I/O Terms	
Accumulator	Register used to accumulate or store up a sum or count of many items or events.
Clear	A special function to zero out the value in a specific register. (Not used with Frequency or Period Measurement.)
Disable	A special function to prevent the counter from running.
Encoder	A sensor or transducer for converting rotary motion or position to a series of electronic pulses
FPGA	An integrated, configurable circuit that allows the controller to be programmed to have either two high-speed counters or four high-speed counters.
Frequency Input	The number of times an electromagnetic signal repeats an identical cycle in a unit of time, usually one second.
Latch (strobe)	A special function that uses a digital logic circuit to store one or more bits. A latch has a data input, a clock input and an output. When the clock input is active, data on the input is "latched" or stored and transferred to the output register either immediately or when the clock input goes inactive. The output retains its value until the clock goes active again.
Marker	Input into the OCS that indicates a particular position. Typically, an encoder has a marker output that represents a specific point in the rotation.
Polarity	A Polarity pull-down box is associated with each function and indicates the manner in which the trigger happens (e.g., High level, Low Level, Falling Edge, Rising Edge).
Preload (load)	A special function used to trigger loading of a value into a register upon an event. (Not used with Frequency or Period Measurement.)
Quadrature	A high-speed device that expresses the phase relationship between two periodic quantities of the same period when the phase difference between them is one fourth of a period. A coupler in which the two output signals are 90° out of phase.
Totalizer	A counter that sums the total number of cycles applied to its input.

High Speed Counter (HSC) Functions

The supports two high speed, configurable counters. There are four dedicated inputs that can be configured to a number of different options. Each of the two counters can run in one of five modes. Those modes are Totalizer, Frequency Counter, Pulse Width Measurement, Period Measurement and Quadrature measurement. For some modes, more than one HSC input may be consumed. The measurement values are provided to ladder in a %AI register. Refer to the **System Register** chapter for more details.

Frequency

In frequency mode, the frequency of the input signal is written to the accumulator in terms of Hertz (cycles/second). When using frequency mode, four update selections are provided which specify the width of the sample window.

NOTE: Selecting a shorter sample window provides a quicker measurement (faster response) but lowers the frequency accuracy (resolution) and increases the minimum frequency measurement limit. In this mode the Disable and Latch special functions are allowed. Refer to the "High Speed I/O Glossary " on the previous page"High Speed I/O Glossary " on the previous pagefor a description of these functions.

Totalize

In totalize mode, the accumulator is simply incremented or decremented each time the input transitions in a specific direction.

The totalizer supports the following modes:

Internal	This mode ties the input to the counter to an internal 10MHz or 1MHz clock. The special functions can be used to accurately time events.
Count Up	This increments the accumulator when the input is enabled. NOTE: Two inputs can be assigned. Either input can cause the counter to increment. The second input can also be disabled.
Count Down	This decrements the accumulator when the input is enabled. NOTE: Two inputs can be assigned. Either input can cause the counter to decrement. The second input can also be disabled.
Up/Down (Input 1 Up/In-put 2 Down)	In this mode, Input 1 (assigned to any of the four inputs) increments the counter, while Input 2 (also assigned to any of the 4 inputs) decrements the counter.
Clk/Dir (Input 1 Clk, Input 2 Dir)	This mode uses input 1 as a clock signal to increment or decrement the counter and then uses input 2 to decide the direction. Input 2 disabled increments the counter, while input 2 enabled decrements the counter.

NOTE: The totalize mode enables the Disable, Latch, Preload, and Clear special functions. Refer to the "High Speed I/O Glossary " on the previous page for a description of these functions.

NOTE: Counter triggers off the **rising edge** of the signal.



Three different options are available to reset the current count:

- a. Configured reset value - When configuring the Totalize function, a value may be specified under the Counts per Rev column. When the totalizer accumulator reaches this value - 1, the accumulator will reset to zero on the next count. Specifying zero for this value allows the totalizer to count through the full 32-bit range before resetting.
- b. Ladder Control - Setting registers %Q17-20 reset HSC1-4 (respectively) with no additional configuration. When these registers are asserted, the associated totalizer accumulator is reset and held at zero (level sensitive).
- c. Direct digital input control (HSC1 and HSC2 only) - HSC3 (%I11) and HSC4 (%I12) may be configured as hardware digital reset signals for HSC1 and HSC2 (respectively). To enable these inputs as reset signals, specify the type as Totalize Reset (NOTE: The corresponding Totalize HSC must be previously configured before this option is available). The direct digital reset controls are edge sensitive with the edge polarity configurable.

Maximum direct digital reset latency is 100µs.

The totalize function also supports an option which compares the current accumulator value with a supplied Preset Value (PV), which is provided through a %AQ, and drives a physical digital output based on the that comparison.

NOTE: This option (available for HSC1 and HSC2 only) drives Q1 or Q2 output point (respectively) once the associated totalizer accumulator reaches (or exceeds) the PV value. To enable this function, the corresponding PWM function output (Q1 or Q2) must be configured for HSCx Output.

NOTE: Q1 and Q2 are PWM function outputs that may be configured independently as one of the following: standard digital output, PWM, HSCx or stepper output.

Preset values may be modified during run-time. A preset value of zero disables (resets) the totalizer compares function output causing the output to remain low.

Pulse Width Measurement

In pulse width measurement mode, the high-speed input can measure the width of a pulse stream in one of two modes and provides a continuous indication of the last sampled value. In this mode the Disable and Latch special functions are allowed. Refer to the "High Speed I/O Glossary " on page 96 for a description of these functions.

Width High 1 μ s Counts – In this sub-mode the accumulator value will contain the number of 1 μ s counts the pulse is high.

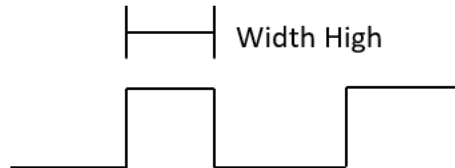

Width Low 1 μ s Counts - In this sub-mode the accumulator value will contain the number of 1 μ s counts the pulse is low.

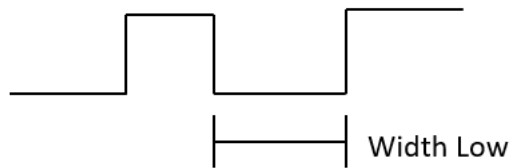

Period Measurement

In period measurement mode, the high-speed input can measure the period of a pulse stream in one of two modes and provides a continuous indication of the last sampled value. In this mode, the Disable and Latch special functions are allowed. Refer to the "High Speed I/O Glossary " on page 96 for a description of these functions.

Period Rising Edges 1 μ s Counts – In this sub-mode the period of the input signal is reported in one (1) μ s units. The period measurement will start on the rising edge of the input.

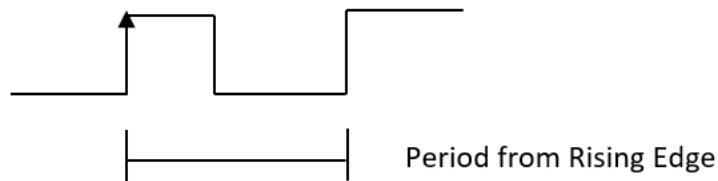

Period Falling Edges 1 μ s Counts – In this sub-mode the period of the input signal is reported in 1 μ s units. The period measurement will start on the falling edge of the input.

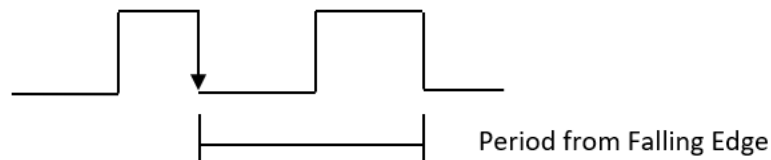

Quadrature

Quadrature mode uses two HSC inputs, any of the four HSC inputs can be assigned for this purpose.

Quadrature mode works much like the totalizer except the accumulator will automatically increment or decrement based on the rotation phase of the two inputs. See the following example for more details. Quadrature inputs are typically used for reporting the value of an encoder.

Two modes are available for quadrature that select whether the accumulator counts up or down when the phase of Input 1 leads Input 2. Check your encoder's documentation to determine the output form it uses or try both modes to determine if the encoder counts up when expected.

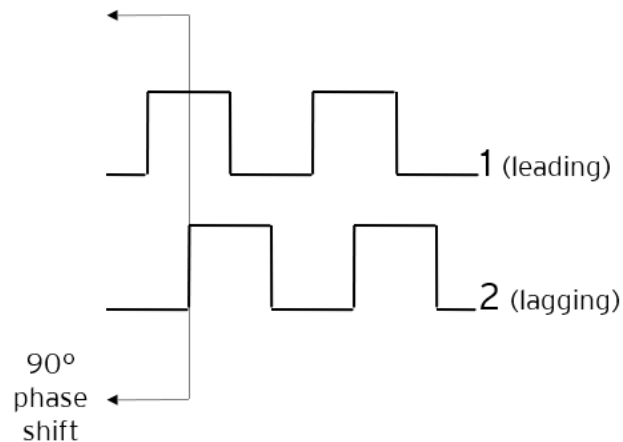

Using the above waveforms and a HSC input configuration of "Quadrature" - "1 leads 2, count up," the accumulator will count up when 1 is rising and 2 is low, 1 is high and 2 is rising, 1 is falling and 2 is high, and when 1 is low and 2 is falling. This results in 4 counts per revolution. So in order to determine the number of cycles, the accumulator would have to be divided by 4.

Marker reset operation is configured in the special operations and can be assigned to any of the 4 high speed inputs or can be assigned to be controlled by a "Q" bit in ladder.

NOTE: The quadrature mode enables the Disable, Latch, Preload, Clear and Marker special functions. Refer to the "High Speed I/O Glossary" on page 96 for a description of these functions.

Register Match

Totalizer & Quadrature counter modes support a register match function. When the accumulator value matches either the Match 1 or Match 2 value configured in the corresponding %AQ registers, a high-speed output can Turn On, Turn Off, or Toggle. An internal %I register mirrors the output state whether the high-speed output is configured or not. The output can be reset in program logic using the corresponding %Q registers.

1. 2-Counter Mode has Register Match support for both counters.
2. 4-Counter Mode has Register Match support only for counters 1 and 2.
3. The High-Speed Outputs are %Q1 for Counter 1 and %Q2 for Counter 2. They operate as high-speed outputs, independent of the controller scan rate, when configured as 'HSC Output' in the Digital Out/PWM configuration in Cscape.
4. The High-Speed Output state reflects in the status register "High Speed Out", e.g. %I1603 for Counter 1 (the update speed of the status bit is scan rate dependent)
5. The High-Speed Output can be reset through ladder with the assigned output, e.g. %Q1606 for Counter 1
6. Both Match 1 and Match 2 values will trigger the match function.
7. If the output is already triggered by any Match register while using 'Turn On' or 'Turn Off' modes, subsequent matches will not affect the output.
8. If using 'Toggle' mode, every match of either Match value will toggle the output to the opposite state.

HSC Functions

The high-speed input on the OCS contains many optional tasks. All of which can be disabled, or set to an internal pre-assigned register (Assigned %Q) or to one of the external high speed inputs (External Input #1, 2, 3, or 4), or they can be set as an "overflow interrupt" or "underflow interrupt" meaning that they will occur when either the Overflow or Underflow input has been activated.

- **Disable:** When the Disable function is active, it will "disable" the high-speed inputs and no longer count pulses until it is re-enabled
- **Latch:** When the Latch function is active, it takes the current value of the Accumulator and moves it into the "Latch Value" register
- **Preload:** When the pre-load function is active, it will take the value from the "Preload" register and put it into the "Accumulator" for the corresponding Counter.
- **Clear:** When the clear function is active, it will move a value of 0 into the "Accumulator" for the corresponding counter.
- **Marker:** When the marker function is enabled, it acts as a dynamic enable/disable for the Disable, Latch, Preload, and Clear functions. If the marker is enabled and "Assigned %Q" is selected, then both the "Disable" and the "Disable Marker" bits need to be set high in order to disable the high-speed input. If the Marker is set for one of the inputs, then the input will need to be "High" in order to use any of the Disable, Clear, Preload, or Latch functions.

Status Bits

There are three status bits (%I registers for each high-speed counter):

- **Overflow Flag:** This status bit turns high when the Accumulator “overflows”, it moves from 4,294,967,295 (-1 if Signed) to 0, this bit can be reset with the “Output Reset Bit”. See Table 9.4.
- **Underflow Flag:** This status bit turns high when the Accumulator “underflows”, it moves from 0 to 4,294,967,295 (-1 if Signed), this bit can also be reset with the “Output Reset Bit”.

NOTE: For the Overflow and Underflow flag registers, if using some sort of counter that counts both up and down, going over the threshold to go negative, triggers the underflow, and then going back over the threshold back into positive numbers will trigger the positive register to go active.

- **High Speed Out:** This register will follow the high-speed output assigned to the counter, it is important to note that this register is still populated within the scan time so the value in this register may not be up to date depending on the timing of the output (it should be up to date within one scan).

HSC Functions Register Maps

The register assignments for the high-speed I/O can be moved via a setting in Cscope. The values shown are the DEFAULT values and may not match the same starting point as the values shown below.

HSC Functions Register Map for 2 HSC Configuration

Register	Frequency	Pulse	Totalize	Quad
%AI401-402	Accumulator - Counter 1			
%AI403-404	Latch Value – Counter 1			
%AI405-406	Accumulator – Counter 2			
%AI407-408	Latch Value – Counter 2			
Counter 1				
%AQ401-402	Preload – Counter 1			
%AQ403-404	Match1 – Counter 1			
%AQ405-406	Match2 – Counter 1			
%AQ407-408	Preload – Counter 2			
%AQ409-410	Match1 – Counter 2			
%AQ411-412	Match2 – Counter 2			
%AQ413-424	Reserved			
Counter 2				
%Q1601	Latch – Counter 1			
%Q1602	Preload – Counter 1			
%Q1603	Clear – Counter 1			
%Q1604	Disable – Counter 1			
%Q1605	Direction – C 1			
%Q1606	Output Reset – Counter 1			
%Q1607	Preload Disable – Counter 1			
%Q1608	Latch Disable – Counter 1			
%Q1609				Disable Marker – C1
%Q1610				Latch Marker – C1
%Q1611				Preload Marker – C1
%Q1612				Clear Marker – C1
%Q1613-1616	Reserved			
%Q1617	Latch – Counter 2			
%Q1618	Preload – Counter 2			
%Q1619	Clear – Counter 2			
%Q1620	Disable – Counter 2			
%Q1621	Direction – C2			
%Q1622	Output Reset – Counter 2			
%Q1623	Preload Disable – Counter 2			
%Q1624	Latch Disable – Counter 2			
%Q1625				Disable Marker – C2
%Q1626				Latch Marker – C2
%Q1627				Preload Marker – C2

%Q1628				Clear Marker – C2
%I1601	Overflow Flag – Counter 1			
%I1602	Underflow Flag – Counter 1			
%I1603	High Speed Out 1			
%I1604	Reserved			
%I1605	Overflow Flag – Counter 2			
%I1606	Underflow Flag – Counter 2			
%I1607	High Speed Out 2			
%I1608	Reserved			

HSC Functions Register Map for 4 HSC Configuration

NOTE: Four Count Mode requires FPGA update. See "Overview" on page 95.

Register	Frequency	Pulse	Totalize
%AI401-402		Accumulator - Counter 1	
%AI403-404		Latch Value – Counter 1	
%AI405-406		Accumulator – Counter 2	
%AI407-408		Latch Value – Counter 2	
%AI409-410		Accumulator – Counter 3	
%AI411-412		Latch Value – Counter 3	
%AI413-414		Accumulator – Counter 4	
%AI415-416		Latch Value – Counter 4	
Separator			
%AQ401-402		Preload – Counter 1	
%AQ403-404		Match1 – Counter 1	
%AQ405-406		Match2 – Counter 1	
%AQ407-408		Preload – Counter 2	
%AQ409-410		Match1 – Counter 2	
%AQ411-412		Match2 – Counter 2	
%AQ413-414		Preload – Counter 3	
%AQ415-416		Match1 – Counter 3	
%AQ417-418		Match2 – Counter 3	
%AQ419-420		Preload – Counter 4	
%AQ421-422		Match1 – Counter 4	
%AQ421-424		Match2 – Counter 4	
Separator			
%Q1601		Latch – Counter 1	
%Q1602		Preload – Counter 1	
%Q1603		Clear – Counter 1	
%Q1604		Disable – Counter 1	
%Q1605		Direction – C1	
%Q1606		Output Reset – Counter 1	
%Q1607		Preload Disable – Counter 1	
%Q1608		Latch Disable – Counter 1	
%Q1609-1616		Reserved	
%Q1617		Latch – Counter 2	
%Q1618		Preload – Counter 2	
%Q1619		Clear – Counter 2	
%Q1620		Disable – Counter 2	
%Q1621		Direction – C2	
%Q1622		Output Reset – Counter 2	
%Q1623		Preload Disable – Counter 2	
%Q1624		Latch Disable – Counter 2	
%Q1625-1632		Reserved	

%Q1633	Latch – Counter 3		
%Q1634			Preload – Counter 3
%Q1635			Clear – Counter 3
%Q1636	Disable – Counter 3		
%Q1637			Direction – C3
%Q1638			Output Reset – Counter 3
%Q1639			Preload Disable – Counter 3
%Q1640			Latch Disable – Counter 3
%Q1641-1648	Reserved		
%Q1649	Latch – Counter 4		
%Q1650			Preload – Counter 4
%Q1651			Clear – Counter 4
%Q1652	Disable – Counter 4		
%Q1653			Direction – C4
%Q1654			Output Reset – Counter 4
%Q1655			Preload Disable – Counter 4
%Q1656			Latch Disable – Counter 4
%Q1657-1664	Reserved		
%I1601	Overflow Flag – Counter 1		
%I1602	Underflow Flag – Counter 1		
%I1603	High Speed Out 1		
%I1604	Reserved		
%I1605	Overflow Flag – Counter 2		
%I1606	Underflow Flag – Counter 2		
%I1607	High Speed Out 2		
%I1608	Reserved		
%I1609	Overflow flag – Counter 3		
%I1610	Underflow flag – Counter 3		
%I1611	High Speed Out 3		
%I1612	Reserved		
%I1613	Overflow flag – Counter 4		
%I1614	Underflow flag – Counter 4		
%I1615	High Speed Out 4		
%I1616	Reserved		

High Speed Output Functions

On units that support high-speed output functions, two dedicated outputs are available that can be configured for one of four modes of operation. Those modes are Normal, PWM, HSC Match and Stepper.

Normal

When either Q1 or Q2 is configured for Normal operation, the digital output registers %Q1 and %Q2 drives that respective output.

PWM

When either Q1 or Q2 is configured for PWM, the PWM function drives that respective output. Both PWM channels may be individually enabled and can have independent frequency and duty cycles.

The PWMs require two parameters (%AQs) to be set for operation. These parameters may be set at run-time.

Duty Cycle - The Duty Cycle is a 32-bit value from 0 to 32,000 indicating the relative duty cycle of the output. For example, a value of 8000 would indicate a 25% duty cycle, a value of 16,000 would indicate a 50% duty cycle. Zero (0) turns the output off, 32,000 turns the output on.

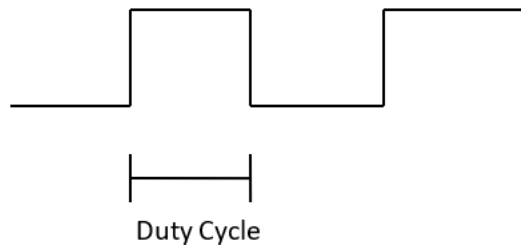

Frequency - The Frequency is a 32-bit value indicating the output frequency in Hertz. One over the frequency is the period.

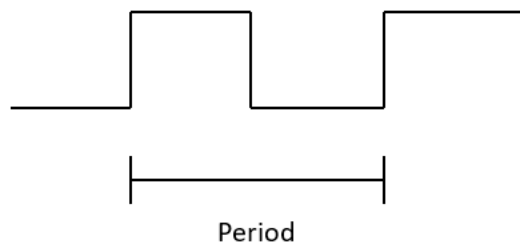

At controller power-up or during a download, the PWM output is maintained at zero until both the Frequency and the Duty cycle are loaded with non-zero values. When the controller is placed in stop mode, the state of the PWM outputs is dependent on the PWM State on Controller Stop configuration. This configuration allows for either hold-last-state or specific frequency and duty cycle counts. Specifying zero for either the period or duty causes the PWM output to remain low during stop mode.

NOTE: For standard I/O models (1E3, 1E4, 1E5, and 1E6) the maximum recommended PWM frequency is 10kHz, due to the limitations of built-in output circuitry. The [HE-XHSQ](#) generates 24V pulse outputs with a recommended max of 400kHz. The HE-XHSQ-5 generates 5V pulse outputs with a recommended max of 1.0MHz. The add-on HSQ and HSQ-5 module can be added to the 1E2 unit for HSC function.

PWM Output Waveform

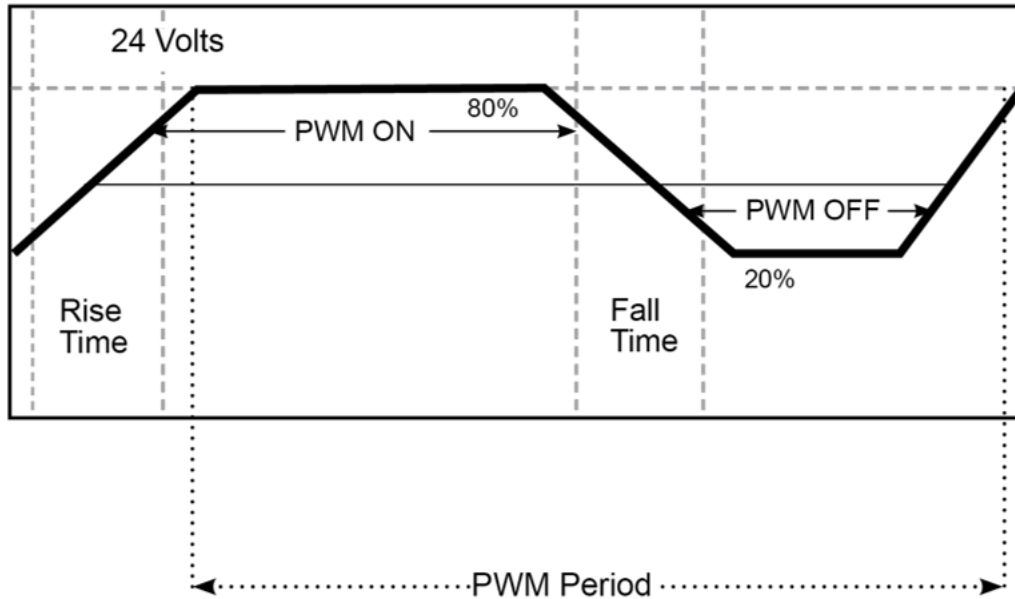

PWM Output Waveform Table	
Rise Time	150ns Max
Fall Time	150ns Max
PWM Period	Frequency = 1/Period

High Speed Counter Match

When either Q1 or Q2 is configured for HSC Output operation, their output state is based on a comparison between the counter accumulator and match registers. Refer to the "HSC Functions Register Maps" on page 104 for more details.

Stepper Function

The OCS supports two stepper functions, one on each high-speed output when in two counter mode. In four counter mode, the OCS supports one stepper function

The Stepper requires five parameters (%AQs) to be set for operation. These parameters may be set at run-time but are 'latched' when the stepper is commanded to start:

Start Frequency (pulses per second)	Sets the frequency for the first cycle during the acceleration phase and the frequency of the last cycle during the deceleration phase. When an acceleration or deceleration count is specified, the Start Frequency must be greater than 0 and must not exceed the run frequency or an error is generated.
Run Frequency (pulses per second)	Sets the frequency for the last cycle during the acceleration phase, the consistent frequency during the run phase, and the frequency of the first cycle during the deceleration mode. The Run Frequency must be greater than 0 and must not exceed 5000Hz (standard), 400,000Hz (HE-XHSQ) or 1.0MHz (HE-XHSQ-5)
Acceleration Count	Sets the number of cycles to occur within the acceleration phase. The frequency of the cycles within this mode will vary linearly between the specified Start and Run frequency. The Accel count must not equal 1 or an error is generated. Setting this value to zero disables this phase.
Run Count	Sets the number of cycles to occur within the run phase. The frequency of the cycles within this mode is constant at the specified Run frequency. The Run count may be any value. Setting this value to zero disables this phase.
Deceleration Count	Sets the number of cycles to occur within the deceleration phase. The frequency of the cycles within this phase will vary linearly between the specified Run and Stop frequency. The Decel count must not equal 1 or an error is generated. Setting this value to zero disables this phase.

The stepper provides two Boolean registers to provide stepper status:

Ready/Done	A high indication on this register indicates the stepper sequence can be started (i.e. not currently busy) and also when the move is completed.
Error	A high indication on this register indicates that one of the analog parameters specified above is invalid or the stepper action was aborted before the operation was complete. This register is cleared on the next start command if the error was corrected.

The stepper requires one discrete register to control the stepper action. Setting this register starts the stepper cycle. This register must remain set to complete the entire cycle. Clearing this register before the cycle is complete aborts the step sequence and sets the error bit.

NOTE: Setting the PLC mode to stop while the stepper is in operation causes the stepper output to immediately drop to zero and the current stepper count to be lost.

NOTE: The stepper output level may cause damage or be incompatible with some motor drive inputs. Consult drive documentation to determine if output level and type is compatible.

High Speed Output Functions Register Map

The register assignments for the high speed I/O can be moved via a setting in Cscope. The values shown are the DEFAULT values and may not match the same starting point as the values shown below.

PWM Functions Register Map, Two Counter		
Register	PWM	Stepper
%AQ421-422	PWM 1 Duty Cycle (32-bit)	Start Frequency – Stepper 1
%AQ423-424	PWM 1 Frequency	Run Frequency – Stepper 1
%AQ425-426		Acceleration Count – Stepper 1
%AQ427-428		Run Count – Stepper 1
%AQ429-430		Deceleration Count – Stepper 1
%AQ431-432	PWM 2 Duty Cycle (32-bit)	Start Frequency – Stepper 2
%AQ433-434	PWM 2 Frequency	Run Frequency – Stepper 2
%AQ435-436		Acceleration Count – Stepper 2
%AQ437-438		Run Count – Stepper 2
%AQ439-440		Deceleration Count – Stepper 2
%Q1*		Start Move Bit – Stepper 1
%Q2*		Start Move Bit – Stepper 2
%I1617		Ready/Done – Stepper 1
%I1618		Error – Stepper 1
%I1619		Ready/Done – Stepper 2
%I1620		Error – Stepper 2

PWM Functions Register Map, Four Counter		
Register	PWM	Stepper
%AQ451-452	PWM 1 Duty Cycle (32-bit)	Start Frequency – Stepper 1
%AQ453-454	PWM 1 Frequency	Run Frequency – Stepper 1
%AQ455-456		Acceleration Count – Stepper 1
%AQ457-458		Run Count – Stepper 1
%AQ459-460		Deceleration Count – Stepper 1
%AQ461-462	PWM 2 Duty Cycle (32-bit)	
%AQ463-464	PWM 2 Duty Frequency	
%AQ465-469	Reserved	
%Q1*	PWM1 Out	Stepper On
%Q2*	PWM2 Out	
%I1649		Stepper Ready/Done
%I1650		Stepper Error

*Q30 and Q31 for model 2 using HSQ or HSQ-5 add-module (necessary to start move)

PWM Examples

Example 1

	Duty Cycle	Frequency
To get a 50% Duty Cycle @ 10kHz waveform on PWM1:	Set %AQ421-422 = 16,000	Set %AQ423-424 = 10,000

Example 2

	Duty Cycle	Frequency
To get a 50% Duty Cycle on PW1 and 0 % Duty Cycle on PWM2 @ 1kHz waveform:	Set %AQ421-422 = 16,000 Set %AQ431-432 = 28,800 (duty cycle (32000 * 0.9))	Set %AQ423-424 = 1,000 Set %AQ433-434 = 1,000

Example 3

	Duty Cycle	Frequency
To turn PWM 1 output ON all the time	Set %AQ421-422 = 32,000	Set %AQ423-424 = Any Value

Example 4

	Duty Cycle	Frequency
To turn PWM 1 output OFF all the time	Set %AQ421-422 = 0	Set %AQ423-424 = Any Value

STP Examples

Example 1

	Start Frequency	Run Frequency	Accel Count	Run Count	Decel Count
10,000,000 steps control sequence	Set %AQ421-2 = 2500 (Hz)	Set %AQ422-4 = 5000 (Hz)	Set %AQ423-6 = 1,000,000 (Steps)	Set %AQ425-8 = 8,000,000 (Steps)	Set %AQ427-30 = 1,000,000 (Steps)
When the start bit is energized, the example starts at 2.5kHz and ramps up to 5kHz during the first 1,000,000 steps. Then, it runs at 5kHz for the next 8,000,000 steps. Finally, during the last 1,000,000 steps it slows to a stop.					

Example 2

	Start Frequency	Run Frequency	Accel Count	Run Count	Decel Count
5,000,000 steps control sequence	Set %AQ421-2 = 500 (Hz)	Set %AQ422-4 = 1000 (Hz)	Set %AQ423-6 = 2,000,000 (Steps)	Set %AQ425-8 = 2,000,000 (Steps)	Set %AQ427-30 = 1,000,000 (Steps)
When the start bit is energized, the example starts at 0.5 kHz and ramps up to 1 kHz during the first 2,000,000 steps. Then, it runs at 1 kHz for the next 2,000,000 steps. Finally, during the last 1,000,000 steps it slows to a stop.					

Example 3

	Start Frequency	Run Frequency	Accel Count	Run Count	Decel Count
6,000,000 steps control sequence	Set %AQ421-2 = 50 (Hz)	Set %AQ422-4 = 250 (Hz)	Set %AQ423-6 = 150,000 (Steps)	Set %AQ425-8 = 5,500,000 (Steps)	Set %AQ427-30 = 350,000 (Steps)
When the start bit is energized, the following example starts at 50Hz and ramps up to 250Hz during the first 150,000 steps. Then, it runs at 250Hz for the next 5,500,000 steps. During the last 350,000 steps it slows to a stop.					

NOTE: Prior to the start of a move, the Ready/Done bit for that channel must be ON (%I1617 or %I1619 for channel 1 and 2 respectfully). The Ready/Done bit will turn OFF during the move, and then back ON once the move is completed.

NOTE: The pulse generation hardware on the OCS can generate any frequency that can be evenly divided into 10MHz (10,000,000Hz) under the maximum recommended frequencies for each model. This results in a very smooth operation at lower frequencies, with a progressively choppier operation at higher frequencies, as the units reach their maximum recommended frequency.

HSC I/O Filtering

This feature is used to enable digital Filter for HSC Inputs.

Selecting Digital In/HSC configuration opens up the following dialog where in HSC I/O Filtering is available.

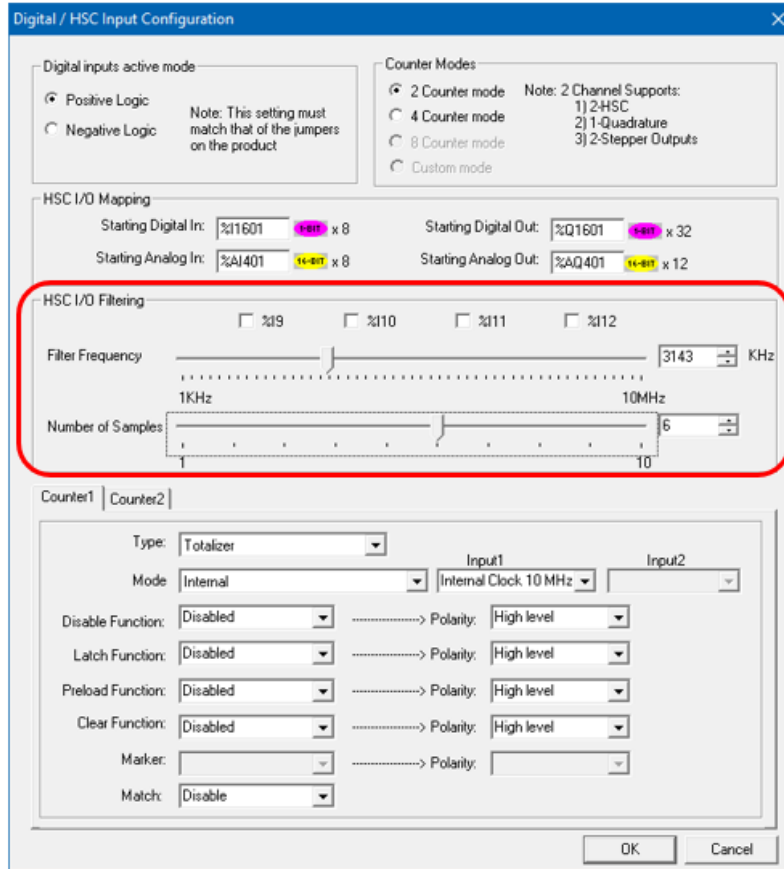

Input signal is filtered based on the filter frequency and Number of samples selected. User has to select Filter Frequency and Number of samples based on the frequency of the Input signal.

Filter Frequency: To set the filter, choose a value that is: $4 * \text{Number of Samples} * \text{Expected Max Hz}$ on the high-speed inputs.

Number of samples: The input must be stable for this many samples before the HSC accumulator is affected by any change.

The state (high or low) of the high-speed input is sampled with every rising input edge of the filter frequency. The rising edges of the filter frequency are totaled in a sample counter, and when that total equals the number of samples configured, the sample counter is reset. If the high-speed input state did not change by the time of the sample counter reset, that state, high or low, is passed on to the high-speed accumulator. If the high-speed input state changes during the sample counting, the sample counter is reset to zero and the process starts over.

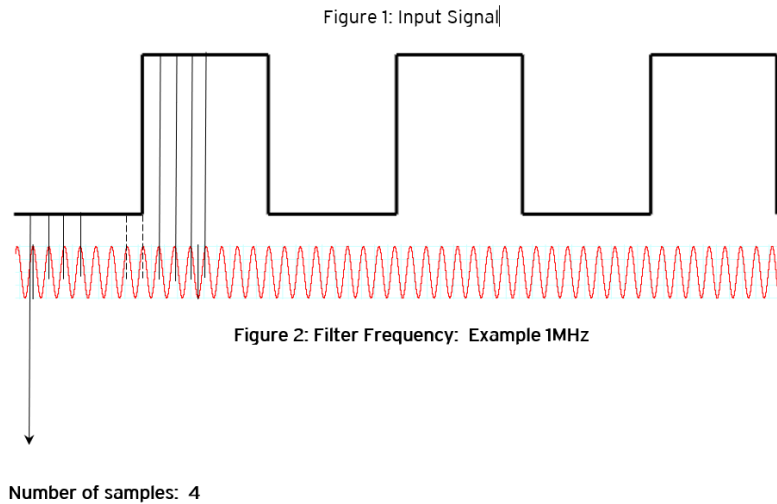

If user selects filter frequency as 1MHz and Number of samples as 4, then Input signal is sampled for 4 samples and if the signal is stable for 4 samples i.e. 4µs then the signal is passed to Accumulator.

If the Input state is changed in between the sampling counts, then the count is reset, and the Input state is again checked for given number of samples.

Refer to Dotted lines in the Figure 2, after 2 samples the state of input signal changes to 1, so the counter is again started to count 4 samples, to pass the signal to accumulator.

There will be a delay in passing the input signal to accumulator since we are filtering the Input signal and the delay is based on the selected filter frequency and Number of samples. In the above example filter frequency is 1MHz (1µs) and number of samples: 4, so the minimum delay in input signal will be 4µs.

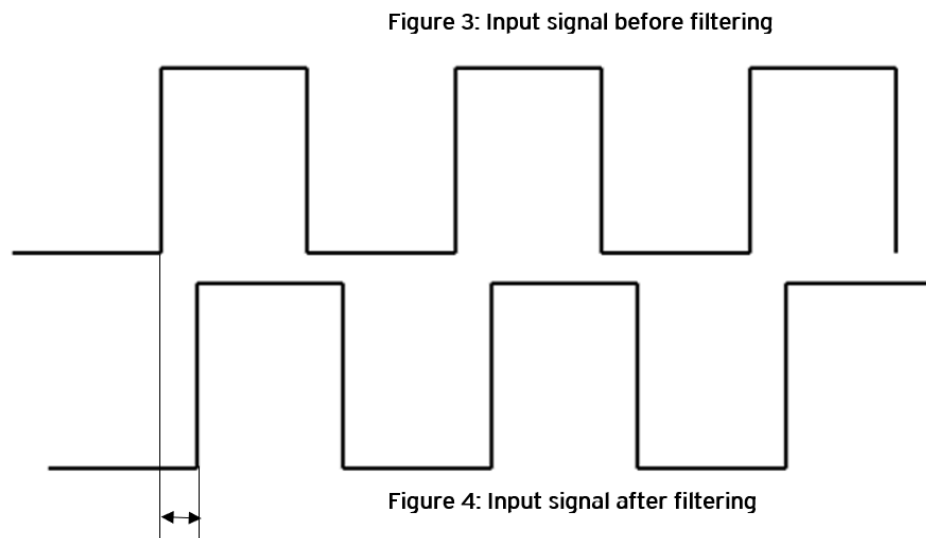

This delay will be 4µs.

Serial Communications



Serial Communications

Port Descriptions	117
Wiring	117
Dip Switches	118
RS485 Termination	118
RS485 Biasing	118
Cscape Programming via Serial Port	119
Ladder-Controlled Serial Communication	119
Configuration via Mini-B USB	119

All EXL6/XL6 PRIME OCS models provide two independent serial ports, on the first 8-pin modular RJ45 connector, which is labeled **MJ1/MJ2**. The MJ1 serial port is RS232 while the MJ2 port is RS485. By default, MJ1 can be connected to the COM port of a PC running Cscape, for OCS programming. In addition, both MJ1 and MJ2 can be used for application-specific communication, using a variety of standard data exchange protocols.

The second 8-pin modular RJ45 connector, which is labeled **MJ3**, provides a multiplexed serial port, which can be configured for either RS232 or RS485. MJ3 can be optionally set for OCS programming via the System Menu for connection to the COM port of a PC running Cscape.

Port Descriptions

The MJ1 serial port contains an RS232 interface with RTS/CTS handshaking. The MJ2 serial port contains a half-duplex RS485 interface with no handshaking. The MJ3 serial port can be configured as either RS232 or RS485. The MJ2 and MJ3 RS485 interfaces provide switchable termination and bias resistors internally, which can be enabled/disabled with DIP switches.

Wiring

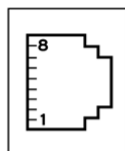

MJ1/2 SERIAL PORTS
 Two Serial Ports on One Module Jack (8posn)
 MJ1: RS-232 w/Full Handshaking
 MJ2: RS-232 Half-Duplex

MJ1 PINS			MJ2 PINS	
PIN	SIGNAL	DIRECTION	SIGNAL	DIRECTION
8	TXD	OUT	--	--
7	RXD	IN	--	--
6	OV	GROUND	OV	GROUND
5	+5V @ 60mA	OUT	+5V @ 60mA	OUT
4	RTS	OUT	--	--
3	CTS	IN	--	--
2	--	--	RX- / TX-	IN / OUT
1	--	--	RX+ / TX+	IN / OUT

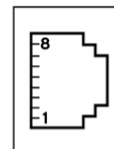

MJ3 SERIAL PORT
 2 Multiplexed Serial Ports on One Modular Jack (8posn)

MJ3 PINS		
PIN	SIGNAL	DIRECTION
8	TXD RS232	OUT
7	RXD RS232	IN
6	OV	GROUND
5	+5V @ 60mA	OUT
4	TX- RS485	OUT
3	TX+ RS485	OUT
2	RX- RS485	IN
1	RX+ RS485-	IN

Dip Switches

The DIP switches are used to provide a built-in termination to both the MJ1, MJ2 & MJ3 ports if needed. The termination for these ports should only be used if this device is located at either end of the multidrop/daisy-chained RS-485 network.

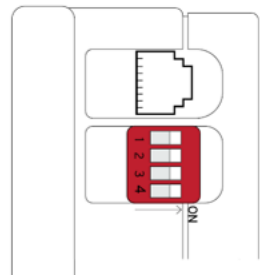

DIP SWITCHES			
PIN	NAME	FUNCTION	DEFAULT
1	MJ3 RS485 Termination	ON = Terminated	OFF
2	MJ3 Duplex	ON = Half	OFF
3		OFF = Full	OFF
4	MJ2 RS485 Termination	ON = Terminated	OFF

RS485 Termination

Proper RS485 termination minimizes signal reflections and improves reliability. Both the MJ2 and MJ3 serial ports allow an internal termination resistor to be placed across pins 1 and 2 by DIP Switch Setting.

Only the two devices physically located at the endpoints of the RS485 network should be terminated.

RS485 Biasing

RS485 biasing passively asserts a line-idle state when no device is actively transmitting, which is useful for multi-drop RS485 networking.

Both the MJ2 and MJ3 serial ports allow internal bias resistors to be switched in, pulling pin 1 up to 3.3V and pulling pin 2 down to ground. The Set Serial Ports item in the System Menu can be used to enable RS485 biasing. Also, an application graphics screen that writes to %SR164 can do the same thing. Setting %SR164.1 enables MJ2 biasing and setting %SR164.2 enables MJ3 biasing.

If biasing is used, it should be enabled in only one of the devices attached to the RS485 network.

Cscape Programming via Serial Port

The EXL6/XL6 PRIME OCS MJ1 and MJ3 serial ports support CsCAN Programming Protocol. If a PC COM port is connected to the EXL6/XL6 PRIME OCS MJ1 or MJ3 serial port, Cscape can access the EXL6/XL6 PRIME OCS for programming and monitoring. Programming can also be done via the CAN port, USB A port, or Ethernet.

Ladder-Controlled Serial Communication

Using Serial Communication function blocks, MJ1, MJ2 and MJ3 serial ports support Generic Modbus Master and Modbus Slave Protocols. In addition, external modems can be connected and accessed using Init and Dial and Answer Modem function blocks.

Configuration via Mini-B USB

NOTE: The unit must be connected via the mini-USB port to the PC or laptop.

It is possible to load the program and monitor data via the Mini-B USB. To load via Mini-B USB, configure the communications port in Cscape as follows:

Select **Tools** from the toolbar > **Application Settings** > **Communications** > **USB button**

It is possible to download or upload and use the data monitoring functions once connected.

NOTE: It is advisable to use an isolated USB cable between the PC or laptop and the EXL6/XL6 PRIME when third party devices are connected to the EXL6/XL6 PRIME to avoid damage to the PC or laptop and/or the EXL6/XL6 PRIME.

CAN Communications



CAN Communications

Port Description	121
CAN1 Port Wiring	121
CsCape Programming via CAN	122
Ladder-Controlled CAN Communication	122
Using CAN for I/O Expansion (Network I/O)	122

NOTE: For additional CAN information, refer to the CAN Networks manual, MAN0799 ([MAN0799](#)) using Horner's [Documentation Search](#) page.

OCS models provide A CAN network port, which is implemented with 5-pin connectors. The CAN port allows the OCS to exchange global data with other OCS controllers and to access remote Network I/O devices (SmartStix, Smart Blocks and Smart Rail Modules). The port also supports pass-through communications for programming multiple OCS controllers over the CsCAN network. Also, the CAN port supports CsCAN, CANopen, J1939, and DeviceNet Master (layer 3 as a selectable option).

Port Description

The OCS CAN ports implement the ISO 11898-2 physical layer and the CAN 2.0A data link layer standards. Also, since the CAN ports are powered by an internal isolated power supply, external CAN power is not required.

NOTE: The CAN port does not supply power to the network.

CAN1 Port Wiring

CAN Connector

Use the CAN Connector when using CsCAN or other CAN network.

Torque Rating:
4.5 - 7 in-lbs
(0.50 - 0.78 N-m)

CAN Network & Power Port Pin Assignments		
Pin	Signal	Signal Description
1	V-	CAN and Device Ground - Black
2	CN_L	CAN Data Low - Blue
3	SHLD	Shield Ground - None
4	CN_H	CAN Data High - White
5	V+	Positive DC Voltage Input (10-30VDC) - Red

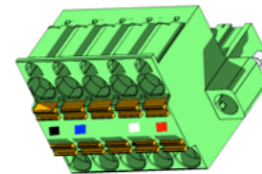

Cscape Programming via CAN

The CAN port supports CsCAN Programming Protocol. If a PC has a CAN interface installed (via PCI card or USB), and the PC CAN port is connected to the OCS CAN port, Cscape can access the OCS for programming and monitoring.

In addition, the OCS supports single-point-programming of all OCS devices that are connected to the CAN port network. If the PC COM port is connected to the OCS MJ1 serial port, the OCS can act as a pass-through gateway allowing Cscape to access all OCS devices that are attached to the CAN port network.

Ladder-Controlled CAN Communication

Using Put and Get Network Words function blocks, the CAN1 port can exchange digital and analog global data with other devices (nodes) attached to the CAN network.

In addition, Put and Get Network Heartbeat function blocks allow nodes on the CAN network to regularly announce their presence and to detect the presence (or absence) of other nodes on the network.

Using CAN for I/O Expansion (Network I/O)

Connecting network I/O devices (SmartStix, SmartBlock, SmartMod, or SmartRail) to the OCS CAN1 port, allows the OCS I/O to be economically expanded and distributed. A variety of modules are available for this purpose.

Ethernet Communication



Ethernet Communications

Ethernet Module Protocols and Features	124
Ethernet Module Specifications	125
Ethernet Module Configuration	125
Ethernet Configuration – IP Parameters	128
Ethernet Module Protocol Configuration	128

Ethernet Module Protocols and Features

The EXL6/XL6 Prime controller supports the following:

1. Downloadable Protocols: **Modbus Client**
2. ETN300 Protocols: **ICMP (Ping), EGD, Modbus Slave, Ethernet I/P, FTP, ASCII over TCP/IP**
3. Supports a maximum of 4 WebMI simultaneous connections
4. Ethernet SmartRail

The following table describes the Ethernet Module Protocols and features supported by the Ethernet port on the EXL6/XL6 Prime .

Protocol / Feature	Protocol / Feature Description
ICMP (Ping)	Internet Control Message Protocol
EGD	Ethernet Global Data
SRTP Slave (90-30 Service Request)	Service Request Transfer Protocol
CsCAN TCP Server	Horner APG CsCAN over Ethernet (for Cscape to OCS programming)
Modbus Slave	Modbus over Ethernet
Ethernet / IP	ODVA CIP over Ethernet
FTP (File Server)	File Transfer Protocol
HTTP (Web Server)	HyperText Transfer Protocol (Web Server)
ASCII over TCP/IP	ASCII Data over Ethernet
NTP Protocol	Network Time Protocol (Obtain clock from web-based server)

Ethernet Module Specifications

Speeds	10 BaseT Ethernet (10Mbps) 100 BaseTx Fast Ethernet (100Mbps)
Modes	Half or Full Duplex
Auto-Negotiation	Both 10/100Mbps and Half/Full Duplex
Connector Type	Shielded RJ-45
Cable Type (Recommended)	CAT5 (or better) UTP
Port	Auto MDI/MDI-X (Auto Crossover)

Ethernet Module Configuration

NOTE: The following configuration is required for all applications regardless of the protocols used. Additional configuration procedures must be performed for each protocol used.

To configure the Ethernet Module, use Cscape Programming Software to perform the following steps:

1. On the main Cscape screen, select the **Controller** menu and its **Hardware Configuration** sub-menu to open the Hardware Configuration dialog.
2. If configuring a different OCS Model than the one shown in the **Hardware Configuration** dialog, click on the topmost Config button, select the desired OCS Model, and then click **OK**.

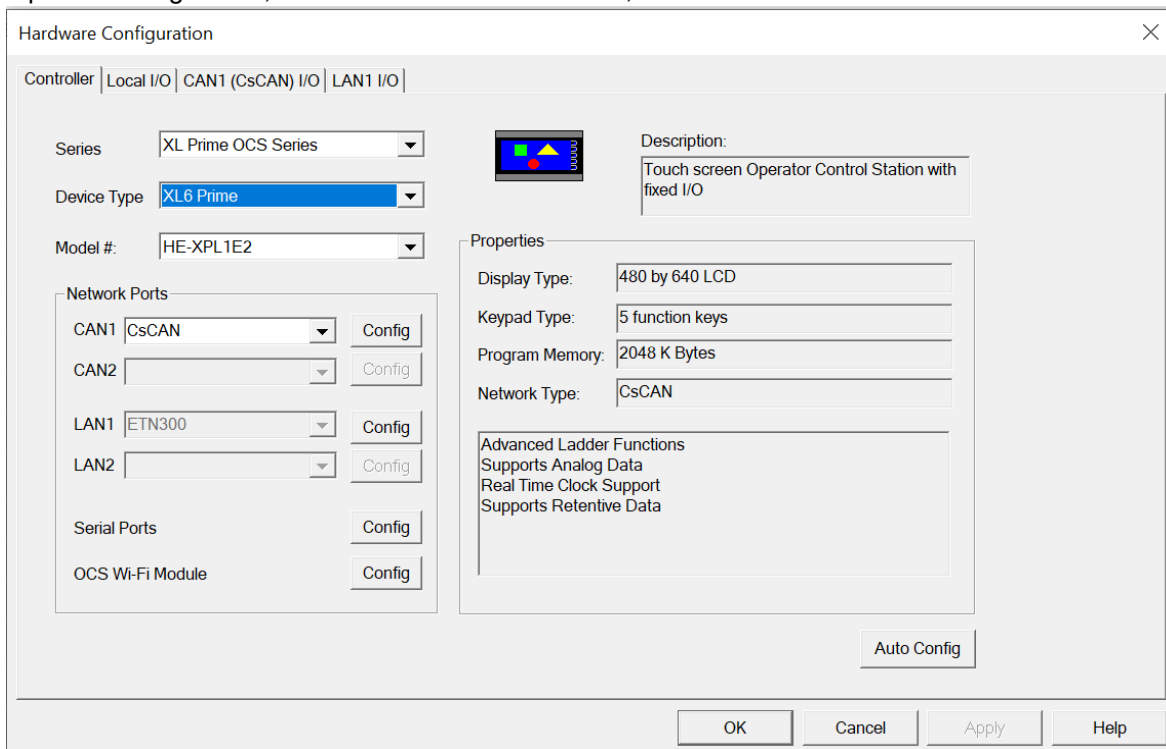

Hardware Configuration

Controller | Local I/O | CAN1 (CsCAN) I/O | LAN1 I/O

Series: XL Prime OCS Series

Device Type: XL6 Prime

Model #: HE-XPL1E2

Description: Touch screen Operator Control Station with fixed I/O

Properties:

- Display Type: 480 by 640 LCD
- Keypad Type: 5 function keys
- Program Memory: 2048 K Bytes
- Network Type: CsCAN

Advanced Ladder Functions:

- Supports Analog Data
- Real Time Clock Support
- Supports Retentive Data

Network Ports:

- CAN1: CsCAN [Config]
- CAN2: [Config]
- LAN1: ETN300 [Config]
- LAN2: [Config]
- Serial Ports: [Config]
- OCS Wi-Fi Module: [Config]

Auto Config

OK Cancel Apply Help

- Click the **Config** button to the right of the LAN1 for LAN 1 or LAN2 for LAN 2, revealing the Ethernet Module Configuration dialog.

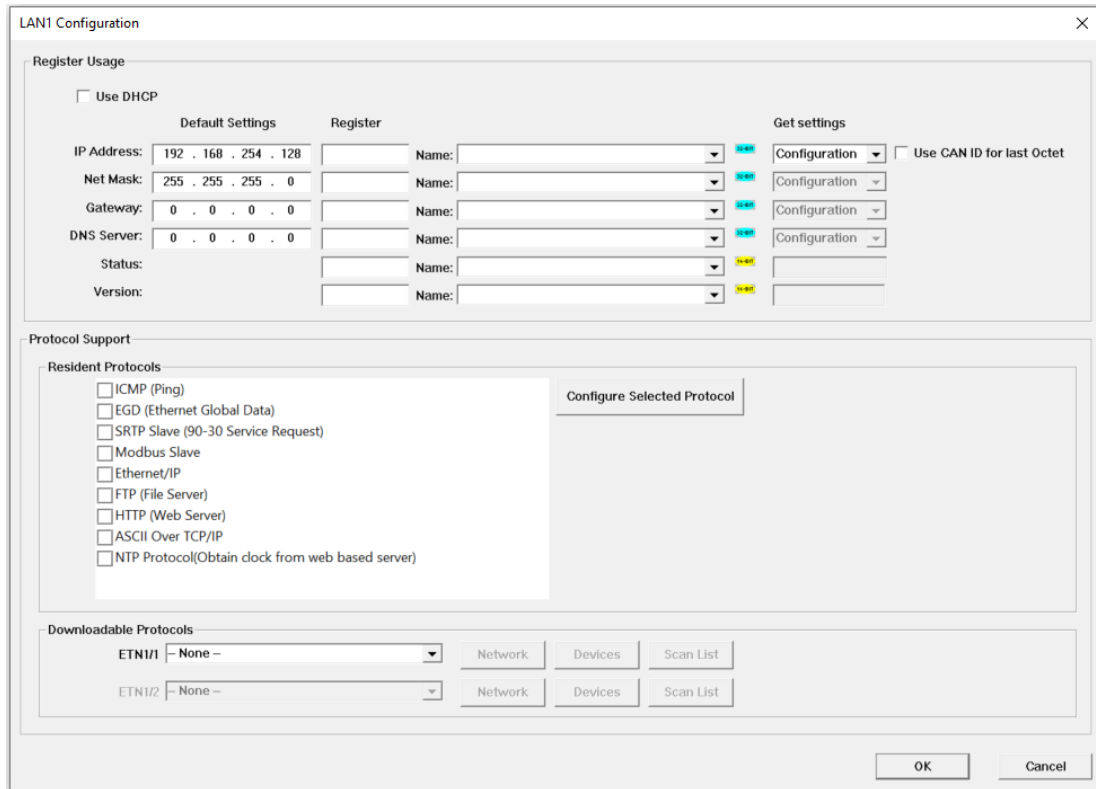

- Configure the Ethernet Module parameters as follows:

IP Address: Enter the static IP Address for the Ethernet Module being configured.

NOTE: IP Addresses are entered as four numbers, each ranging from 0 to 255. These four numbers are called octets, and they are always separated by decimal points.

Net Mask: Enter the Net Mask (sometimes called Subnet Mask) being used by all nodes on the local network. Typical local networks use Class C IP Addresses, in which case the low octet (rightmost number) is used to uniquely identify each node on the local network. In this case, the default Net Mask value of 255.255.255.0 should be used.

Gateway: Enter the IP Address of a Gateway Server on the local network that allows for communication outside of the local network. To prevent the Ethernet Module from communicating outside the local network, set the Default Gateway IP Address to 0.0.0.0 (the default setting).

Status Register: Enter an OCS Register reference (such as %R100) to indicate which 16-bit OCS register will have the Ethernet Status word written to it. The table shows how this register value is formatted and explains the meaning of each bit in the Status Word.

Ethernet Status Word Register Format															
High Byte								Low Byte							
Bit 16	Bit 15	Bit 14	Bit 13	Bit 12	Bit 11	Bit 10	Bit 9	Bit 8	Bit 7	Bit 6	Bit 5	Bit 4	Bit 3	Bit 2	Bit 1
0	0	Dup	Spd	0	Rx	Tx	Link	TCP Connections							
Status Bit		Status Indication						Status Values							
								Minimum	Maximum						
0		Reserved						Always 0							
Dup		Link Duplex (Auto-Negotiated)						0 = Half Duplex	1 = Full Duplex						
Spd		Link Speed (Auto-Negotiated)						0 = 10 Mbps	1 = 100 Mbps						
Rx		Receive State						0 = Inactive	1 = Active						
Tx		Transmit State						0 = Inactive	1 = Active						
Link		Link State						0 = Down	1 = Up						
TCP Connections		Total Number of Active TCP Connections (CsCAN, SRTP, Modbus, Ethernet IP, FTP, HTTP)						0	40						

Version Register: Enter an OCS Register reference (such as %R101) to indicate which 16-bit OCS register will have the Ethernet Firmware Version written to it. The value stored in the Version Register is (Ethernet Firmware Version * 100). For example, for Ethernet Firmware Version 4.30, the Version register will contain 430.

Get Setting From: “Get settings from” allows the programmer to either configure the IP Address, Net Mask, or Gateway for two functions: Configuration or Register.

Configuration: The configuration for the IP Address, Net Mask, or the Gateway will be assigned using the value in the Default Settings in this window.

Register: The configuration for the IP Address, Net Mask, or the Gateway will be assigned using the values in the registers assigned.

NOTE: The low octet of the IP Address can be replaced with the unit’s CAN Network ID, by checking the **Use CAN ID for last Octet** checkbox.

Ethernet Configuration – IP Parameters

For primary operation, the IP address, Net Mask, and Gateway should be set in the LAN config of the **Cscape Hardware Configuration**. There are options to get IP parameters from the LAN Config or to get parameters from registers. It is possible to set the Ethernet IP parameters from the OCS System Menu, but only as a temporary measure. The following points on IP parameter configuration should be considered.

IP Parameters in Non-Volatile RAM: The IP parameters of the Cscape LAN Config are written to non-volatile RAM on power down. IP parameter settings made in the System Menu are not written to non-volatile RAM. Any IP parameters settings made in the System Menu will be lost after cycling power to the unit. It will revert to the last downloaded Cscape LAN Config that was loaded into non-volatile RAM at power down.

“Cscape LAN Config” / “Get Settings from” Configuration: When ‘Get settings from’ is set to Configuration, the IP parameters specified under ‘Default Settings’ is used after downloading to the controller. The IP parameters are represented in System Menu / Set Networks and can be edited. However, any edits made from System Menu / Set Networks is not retained through a power cycle. After power cycle, the unit reverts to the last downloaded Cscape LAN Config that was loaded into non-volatile RAM at power down.

“Cscape LAN Config” / “Get Settings from” Register: When ‘Get settings from’ is set to Register, the IP parameters are retrieved from the OCS registers assigned in LAN Config. Configured registers must be populated with the desired IP parameters:

- The IP parameters are represented in System Menu / Set Networks.
- The IP parameters cannot be edited from System Menu / Set Networks while the unit is in run mode.
- The IP parameters always follow the values in the registers unless the OCS unit is placed in idle mode. Then the IP parameters can be edited in System Menu / Set Networks. When the OCS is placed back into run mode, it reverts to the registers for IP parameters.

Ethernet Module Protocol Configuration

The Protocol Support area contains a list of all the protocols supported by the platform being configured. To activate a protocol, check its checkbox.

For protocols that require additional configuration, click on a listed protocol to select it and then click the Configure Selected Protocol button. This will open a new dialog with configuration options for the selected protocol. For detailed information on individual protocol configuration, refer to latest version of the [Ethernet Manual](#), SUP0740.

Downloadable Protocols



Protocol Configuration

Overview	130
Protocol Device Driver Selection	131
Network Configuration	132
Device List and Device Configuration	134
Scan List	136

Overview

Through loadable protocol device drivers, certain models of the OCS family can provide the ability to exchange data with remote devices such as variable-frequency drives, PLCs and remote I/O devices. This feature greatly expands the OCS's control capability with negligible effect on the OCS's ladder scan time.

Remote devices that communicate serially must do so under certain rules of data transfer known as a protocol. Many device manufacturers have created their own protocol for communications with their device. For an OCS to communicate with a specific device, it must be loaded with the corresponding serial communications protocol device driver that supports that protocol.

A limited number of protocol device drivers are packaged with the Cscape distribution; however, as more are developed, they will be made available as add-on packages. A device driver is typically distributed as a Windows module, which contains the configuration menus, help files and the target executable driver code. When updating device drivers, an install routine loads the device driver to the Cscape directory structure and makes that driver available to Cscape applications.

Once installed, the protocol device driver can be included as part of a Cscape application by selecting it from a list of installed protocol device drivers and attaching it to the desired serial port (**Home > Protocols**). Only one protocol device driver can be associated with a serial port, though some OCS models support multiple protocols on a single Ethernet port.

Once the protocol is selected for a specific port, that port must be configured to match the bit transfer size and rate of the target device(s). This is configured under the **Network Config** menu, which contains port specific information such as the basic serial port parameters (i.e. baud rate, stop bits parity, retries, etc.). In addition to the serial port parameters, this menu also contains the transaction scan update control configuration and any network level protocol specific configuration.

Once the network is configured, each device on the serial communications network must be configured. For some communications (i.e. RS232), the network can be limited to one device. The devices are configured under the **Device Config** menu, which contains an arbitrary device name, the device ID and optionally an OCS status register that contains any device fault information.

Once each device(s) is configured, a Scan List of entries must be created which defines the transfer of data between a local (OCS) register(s) and a remote device register(s). These entries are created under the Data Mapping menu, which contains an OCS register, a target device ID, a target device register address, the number of registers to transfer, and update type.

Each entry can be configured for one of two types of initiating a transaction: **Polled and Triggered**. Polled type entries initiate a transaction with the remote device on every transaction scan. Triggered type entries only initiate a transaction when a corresponding local (OCS) binary trigger register is set. Once a triggered type transaction completes, the protocol device driver resets the local (OCS) binary register to indicate completion.

These basic types are also subdivided into read or write operations. For polled operations, a Read operation only reads from a remote device. Likewise a Read/Write operation continuously reads from the remote device unless the target OCS register value changes from one ladder scan to another. In this case, the new OCS value is written to the target device. For triggered operations, only a read or write action is available.

When downloaded to the OCS, the Scan List is scanned sequentially to generate data transactions with the remote device. This transaction scanning can be on a continual basis (**automatic**) or controlled from ladder logic (manual) once a complex connection is created via a program. The specific transaction-scanning mode is selected from the **Network Config** menu.

Protocol Device Driver Selection

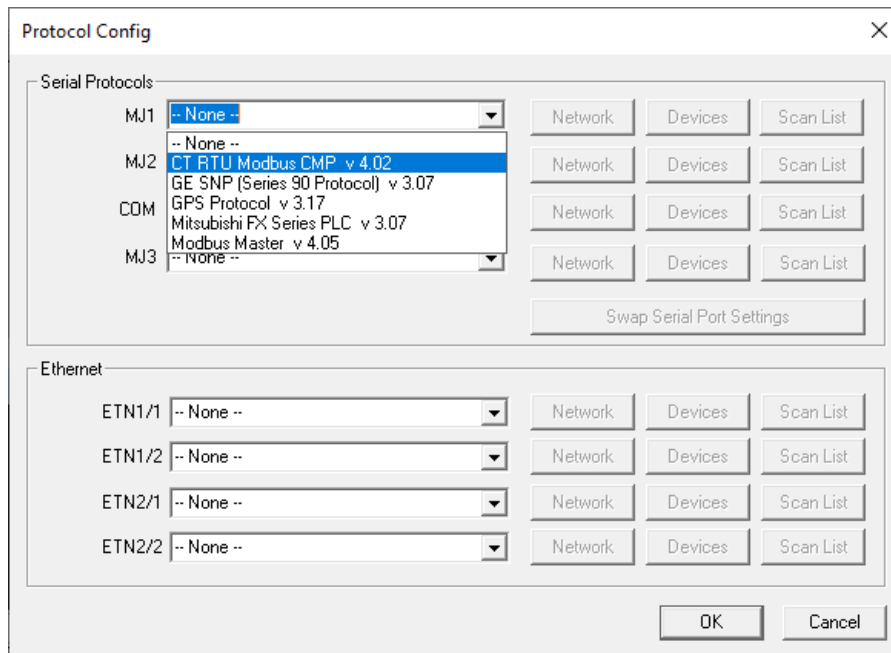

From the Cscape **Home > Protocols** menu, select the port drop-down box to select a protocol device driver. All protocol device drivers currently loaded in Cscape are displayed in the drop down selection along with their version numbers. A selected protocol can be removed by selecting **None** from the drop-down selection. Some OCS models can be limited in the number of ports or number of protocol device drivers that can be selected. Once a protocol is selected, the Network, Devices and Data (Scan List) must be configured through corresponding dialogues accessible through the respective buttons (Network, Devices and Scan List).

Network Configuration

Network Config (Modbus Master)
✕

Port Configuration

Baud Rate: <input type="text" value="9600"/>	Protocol: <input type="text" value="Modbus RTU"/>
Parity: <input type="text" value="None"/>	Mode: <input type="text" value="RS-232"/>
Data Bits: <input type="text" value="8"/>	Retries: <input type="text" value="2"/> (0-255)
Stop Bits: <input type="text" value="1"/>	Timeout: <input type="text" value="10000"/> mSec
Handshake: <input type="text" value="None"/>	Slave Speed: <input type="text" value="Fast"/>

Update Scan

Automatic

Update Interval: mSec ReacquireTime: mSec

Manual

Trigger: Name: 1-BIT

ID Select: Name: 16-BIT

Master ID / Address

Address:

Disable Network

Register: Name: 1-BIT

Status

Register: Name: 4 x 32-BIT

Protocol Help
OK
Cancel

Network Configuration provides the required parameters to configure the network. Each protocol is different and may not require the entire Network Config field. Please refer to the table below for the options in the Network Config field.

Network Protocols		
Baud Rate, Data Bits, Stop Bits, Parity	These field define the bit level transfer over the serial port.	
Handshake	<p>None – No handshake lines are used</p> <p>Multidrop Full – Rx remains active while Tx is occurring.</p> <p>Multidrop Half – Rx is shut off while Tx is occurring.</p> <p>Radio Modem – Wait for CTS acknowledgment before transmitting (legacy radio modem support).</p>	
Protocol	If a driver supports multiple protocols, it is selected here, (i.e. Modbus supports RTU or ANSI).	
Mode	Specifies if port operates in RS232 or RS485 mode.	
Retries	Specifies number of times a transaction is retried on a failed response.	
Timeout	Specifies the amount of time for a device to wait for a valid response.	
Update Scan	Automatic	<p>Update Interval – Specifies the update interval at which all the mapped entries are executed.</p> <p>Reacquire Time – Specifies the amount of time to wait before attempting communications with an offline device.</p>
	Manual	<p>Trigger – Specifies the binary register that a single transaction scan of the Scan List.</p> <p>ID Select – If an analog is specified in the field, the ID Select filter is enabled.</p>
Status Register	Specifies the starting OCS register of eight (8) consecutive registers (4-32bit counters), which provide an indication of the network health.	
Scanner Address	Specifies the OCS's device (network) ID if a master ID is required by the protocol.	
Protocol Help	Provides protocol specific help.	

Device List and Device Configuration

Device List

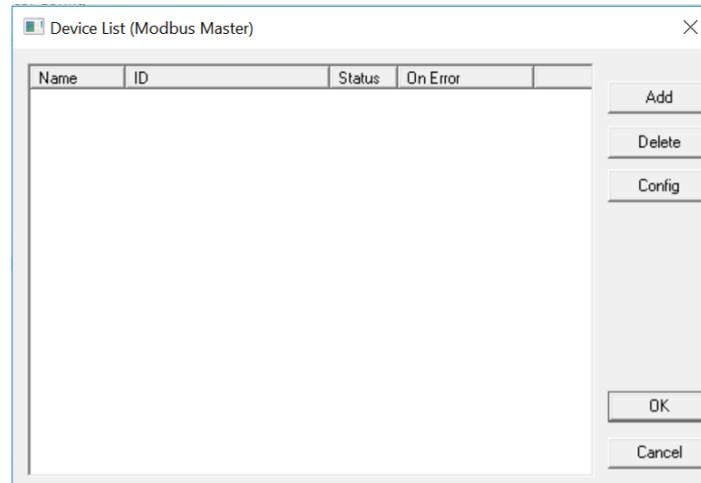

This configuration list is reached from the Device button on the Protocol Config screen and provides a list of the configured devices on the Network. Devices must be created and exist in this list before corresponding Scan List entries can be created for this device. Typically, the number of entries is limited to **128 devices**.

- **Add** - Opens the Device Config dialog to add a new device to the list.
- **Delete** - Remove selected device from list (all corresponding Scan List entries are also removed).
- **Config** - Invoke the Device Config dialog for the currently selected device. This can also be accomplished by double-clicking a device entry.
- **Mapping** - Invoke the Scan List limiting the entries displayed for the selected device.

Device Configuration

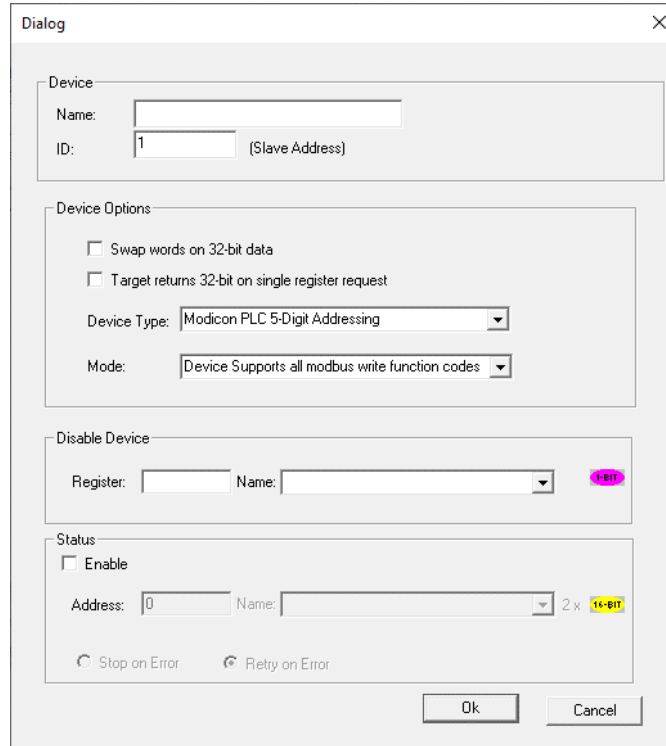

This configuration is reached from the device list when adding or modifying an existing device. While each protocol is somewhat different and can contain protocol specific field, all protocols typically support at least:

- **Device Name** - Specifies a tag name for this device. This tag name is used in the Data Mapping configuration to identify this device. This allows device addresses to be modified without the need to update all associated Data Mapping entries.
- **Device ID** - Specifies the target device communications ID or station address.
- **Swap Words on 32-bit Data** - If a Scan List entry is configured to transfer 32-bits and this option is checked, the high and low 16-bit values are swapped when transferred between the target and OCS.
- **Disable Device** - From Cscape 9.90 SP3 and firmware 15.40 onwards, disable device feature has been added in protocol device configuration. This option is used to disable a particular slave configured in the network. Single bit register has to be configured to use this function. Setting the bit high disables the slave and OCS will not send any serial (TCP for ethernet protocols) packets only to this slave until the bit is high. Setting the bit low enables the communication with the slave again.
- **Status Enable** - This checkbox enables device status to be displayed and controlled from two consecutive 16-bit registers.
- **Status Address** - Enter the starting 16-bit OCS register of two consecutive registers used for device status. The first register contains the protocol device driver specific error code while the second register contains the index of the offending Scan List entry.
- **Status Modes:**
 - a. **Stop on Error** - Specifies that communications be only reattempted after offline status when the corresponding device status register is cleared.
 - b. **Retry on Error** - Specifies that communications be reattempted either during the reacquire interval or when the corresponding device status register is cleared.

Scan List

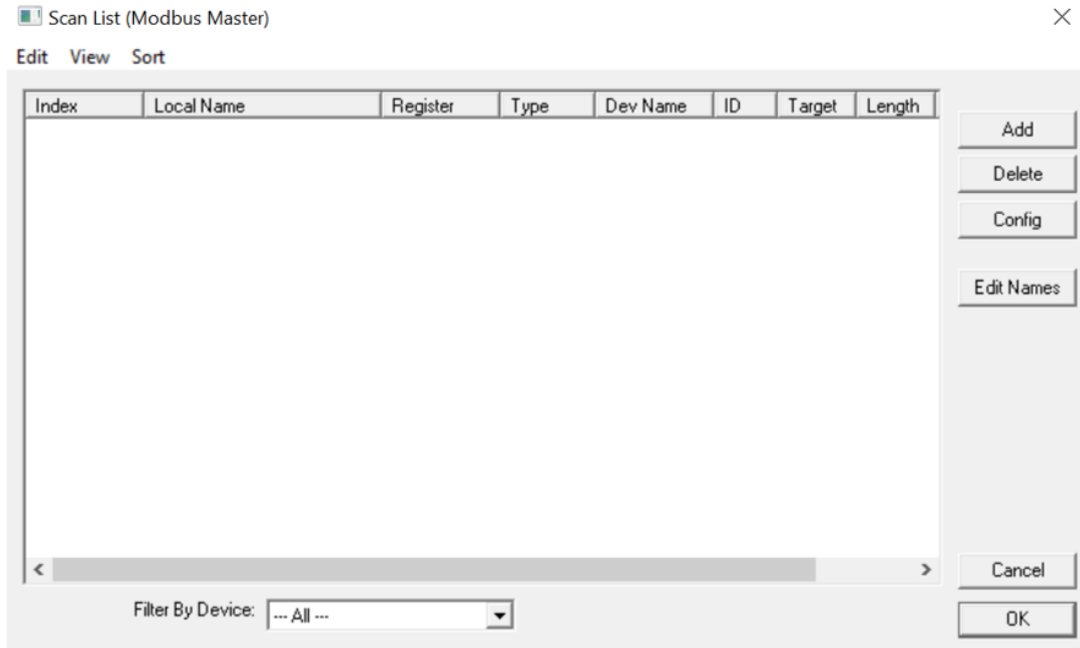

This configuration list is reached from the Scan List button on the Protocol Config screen or the **Mapping** button on the Device List screen and provides a Scan List of the Data Mapping entries. To transfer data between the OCS and remote target, a Scan List must be created that defines each transaction. Each mapping entry (transaction) contains the source and destination registers, the number of consecutive registers transferred, the direction of the transfer and what triggers the transfer. Typically, **the number of entries is limited to 512**.

NOTE: The order of the Scan List is the order in which the transactions occur. Sort functions are provided to change the order of the list. Each entry also has an identifying index. If the device status register is enabled and a transaction failure occurs, the status register indicates the index number of the transaction that failed.

Menu

- **Edit > Copy All** - Copies Scan List to clipboard in a tab delimited format suitable for pasting into an application like Microsoft Excel.
- **Edit > Paste** - Loads Scan List from clipboard. Pasted items are added to the scan list even if they are duplicates.
- **View > Toggle All Name View** - Expands Scan List such that each point and corresponding local name is displayed.
- **Sort** Scan List by different criteria. The firmware will scan the devices based on the order they are displayed or sorted. There are four ways to sort the scan list:
 - a. **By Local Address** – Sorts the list by local register address in increasing order.
 - b. **By Target Address** – Sorts the list by target register address in increasing order.
 - c. **By Device Name** – Sorts by device name, then target address.
 - d. **Interleave Devices** – This sort evenly distributes request among the different devices. Instead of requesting 100 blocks from device A, then 100 blocks from device B, one requests is sent to device A, then one request is sent to device B until all the data has been requested. This is useful for devices that may have a timeout timer because the time between each scan for a particular device is minimized. This sorting options usually doesn't affect performance.

Buttons

- **Add** - Opens the Data Mapping dialog to add a new entry to the Scan List.
- **Delete** - Removes selected entry from Scan List
- **Config** - Opens the Data Mapping dialog for the currently selected entry. This can also be accomplished by double-clicking an entry.
- **Edit Names** - Invokes the Edit Names dialog for the currently selected entry. The Edit Names dialog provides the ability to create OCS program names for each point in the transaction.

Display Control

Filter by Device - Limits displayed entries to only those assigned to the indicated device. To show all entries select **-All-**.

Data Mapping Configuration (Scan List Entry)

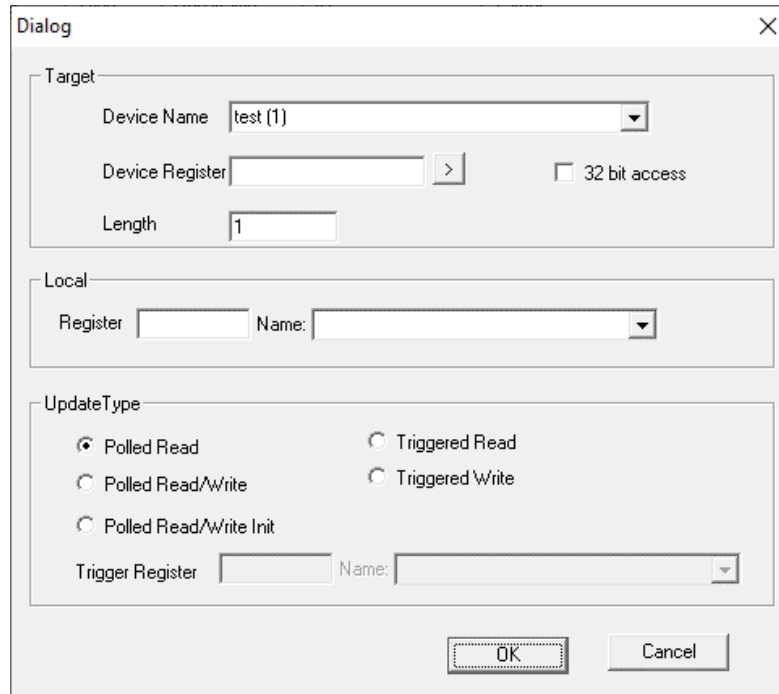

Target

- **Device Name** - Selects the target device (by tag name) to use for this transaction. Only those device entries previously created from the Device Config menu are available.
- **Device Register** - Specifies the target device's register to use for this transaction. This designation is target-specific. The configuration menu displays an error if a specified address is unacceptable. **Generally, the data type of the local (OCS) register must match the data type of the device register.**
- **The Right Arrow button** - Displays protocol device driver specific help for the target addressing. Note that some devices can require register addresses that exist on 8-bit, 16-bit or 32-bit boundaries.
- **Local Register** - Specifies the local (OCS) register that is the source or destination for the transaction.
- **Local Name [Optional]** - Optionally allows selection of a OCS register by name <or> creation of a name for a register already selected by direct reference. Created names can be used thereafter to specify the local (OCS) register in ladder or graphics address fields.
- **32-Bit Access** - Allows two local (OCS) 16-bit registers to be treated as a single 32-bit value. For example, if the value in either 16-bit register is modified, both registers are written to the device. Device-specific, 32-bit word swapping options also apply to this designation. Since the transaction is treated as a 32-bit access, the length is generally limited to 16. Note that some protocols can disable this feature.
- **Length**
 - a. Specifies the number of consecutive device registers that are transferred in this transaction. Note that some protocols can limit the length that can be transferred. However, typically the **length is limited to 32**. The configuration menu displays an error if a specified length is unacceptable.
 - b. **If allowed, specifying a length greater than one (multiple consecutive register transfers per transaction) is more efficient than creating a single transaction for each register.** This grouping of registers per transaction can significantly reduce the transaction scan time; however, **update types that include writing on a polled basis require additional consideration.**
 - c. On **Read/Write** and **Read/Write/Init** update types, the write transaction only occurs when the local (OCS) register value changes. If the length is greater than 1 for Read/Write and Read/Write/Init types, only the local register(s) that change in value are written. More specifically, only one write

transaction occurs per scan per mapping entry for the register or consecutive sub-group of local registers that changed in value. Depending on the protocol, the number of points written with that write transaction are limited either to one or the number of consecutive points that changed value.

- d. **Therefore, if several local registers (specified in a single mapping entry) change in value prior to a transaction scan, it takes SEVERAL transaction scans to complete all the write operations. Furthermore, all write operations are completed before a read operation is scheduled.**
- e. **For Manual Update (transaction) scans (i.e. dialup modem), it is recommended that all Read/Write Scan List entry lengths be limited to 1.**

Update Type

This field specifies the direction and what triggers the transfer of data between the OCS and target device for a mapping entry.

- **Polled Read** - On every transaction scan, a read-only target device register(s) transaction occurs.
- **Polled Read/Write**
 - a. On every transaction scan, a read target device register transaction occurs unless a local register value has changed. The write transaction only updates those local registers that have changed in value. If several non-consecutive local registers (contained in a single mapping entry) change value between transaction scans, it takes several consecutive transaction scans to write each changed register.
 - b. When the OCS is placed in RUN mode, **the initial action for this mapping type is a read target register transaction**. This transaction initializes the local (OCS) register(s) to match that of the remote device register(s). Thereafter, any change to the corresponding OCS register(s) triggers a write operation to the remote device.
- **Polled Read/Write/Init**
 - a. On every transaction scan, a read target device register transaction occurs unless a local register value has changed. The write transaction only updates those local registers that have changed in value. If several non-consecutive local registers (contained in a single mapping entry) change value between transaction scans, it takes several consecutive scans to write each changed register.
 - b. When the OCS is placed in RUN mode, **the initial action for this mapping type is a write target register transaction**. This transaction initializes the target device register(s) to match that of the local (OCS) register(s). Thereafter, any change to the corresponding OCS register(s) triggers a write operation to the remote device.
 - c. The initial write transaction does not occur until after the first logic scan of the OCS . This allows registers to be initialized locally before Writing to the target device register(s).
- **Triggered Read** - A read transaction is triggered by a high level on a separately designated OCS (binary) trigger register. Once the read transaction is complete (or the device is offline), the OCS trigger register is cleared by the OCS . This update type can be used for occasion data accesses such as retrieving trend data. Note that this operation increases the associated transaction scan time and can cause the **Update Interval Exceeded Counter** to increment on a tightly adjusted update interval.
- **Triggered Write** - A write transaction is triggered by a high level on a separately designated OCS (binary) trigger register. Once the write transaction is complete (or the device is offline) the OCS trigger register is cleared by OCS . This function can be used for occasion data accesses such as sending recipe data. Note that this operation increases the associated transaction scan time and can cause the **Update Interval Time Exceeded Counter** to increment on a tightly adjusted update interval.

User Interface



User Interface

Screen Specifications	141
Displaying and Entering Data	142
Alpha-Numeric Keypad	143
Screen Navigation	144
Ladder-Based Screen Navigation	145
Beeper Acknowledgement	145
Touch (Slip) Sensitivity	146
Alarms	146
Removable Media	148
Screen Saver	149
Screen Brightness	149
Touch Screen Pressure	150

This chapter presents the user interface (or operator view) of the EXL6/XL6 Prime and some of the model specific characteristics of the EXL6/XL6 Prime as compared to the rest of the OCS line. This chapter does NOT cover building screens or using the CSCAPE graphics editor. For instructions on creating screens and using the graphics editor, refer to the Help File in CSCAPE.

Screen Specifications

Display Type	5.77" VGA TFT (450 nit typical)
Resolution	640x480
Color	16-bit (65,536)
Screen Memory	17MB
User-Programmable Screens	1023
Backlight	LED – 50,000-hour life

Displaying and Entering Data

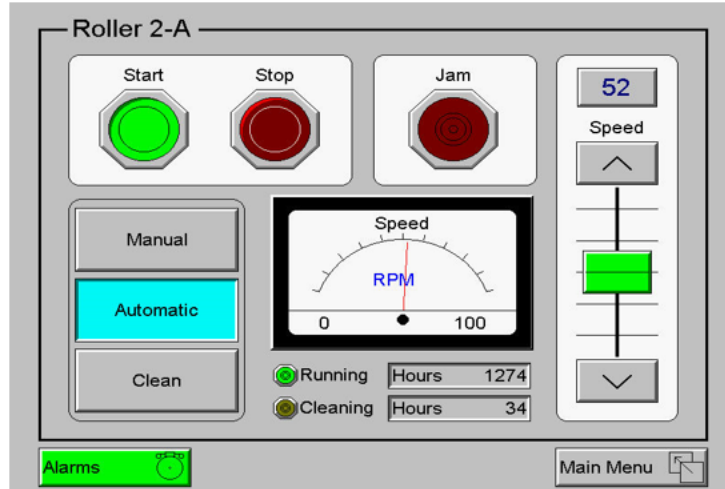

Multiple objects are provided for displaying data such as virtual panel lights, push buttons, numeric value displays, bar graphs, meters, graphs and animated bitmaps. On the EXL6/XL6 Prime, these graphical objects (through ladder manipulation of attribute bits) can change color, flash, or change visibility to attract operator attention.

On objects that accept user input, the input is provided by touching the object or alternately changing an OCS register (i.e. function key registers). Objects that allow input generally have a raised 3D appearance. An exception is the binary type objects, such as buttons, which are shown in a depressed 3D appearance when in the ON state. Objects that normally accept touch input may be disabled through program control (through ladder manipulation of an attribute bit). If an object is disabled, the object's representation changes to a 2D appearance.

On objects that represent non-discrete information, more action may be required beyond that of simply touching the object. For example, the slider object requires the operator to touch and slide the control in the direction desired. Alternately, alpha-numeric entry objects invoke a pop-up alpha-numeric keypad for additional user input. The alpha-numeric keypad is discussed below.

NOTE: If the numeric entry object displays >>>>>>, the value is too big to display in the field or is above the maximum for an editable field. Likewise, if the numeric entry object displays <<<<<< in a numeric field, the value is too small to display or is below the minimum for an editable field.

Alpha-Numeric Keypad

To allow entry of a specific number or text, several of the input objects invoke a pop-up alpha-numeric keypad when the object is touched. An example of the alpha-numeric keypad invoked from a numeric input object is shown below. Once invoked, the operator may touch the appropriate keys to enter a specific value. When entering a value, the alpha-numeric keypad is in one of two modes [new-value or edit-value].

New-Value Mode - Generally, when the alpha-numeric keypad is first invoked, it is placed in new-value mode. Initially, the alpha-numeric keypad displays the current value with all the digits being highlighted. Once the first digit is entered, the current value is erased from the display and the new digit is placed in the first location. Thereafter, no digits are highlighted, and new digits are added to the rightmost position while the other digits are shifted left.

Edit-Value Mode - Edit-value mode may be entered from the initial new-value mode by pressing either the left or right arrow key before any digit key is pressed. The result will be a single character highlighted. The user may then either touch a key to change the digit at the selected position or the up and down arrows may be used to add or subtract (respectively) from the selected digit. The user may then use the left or right arrow keys to select a new position.

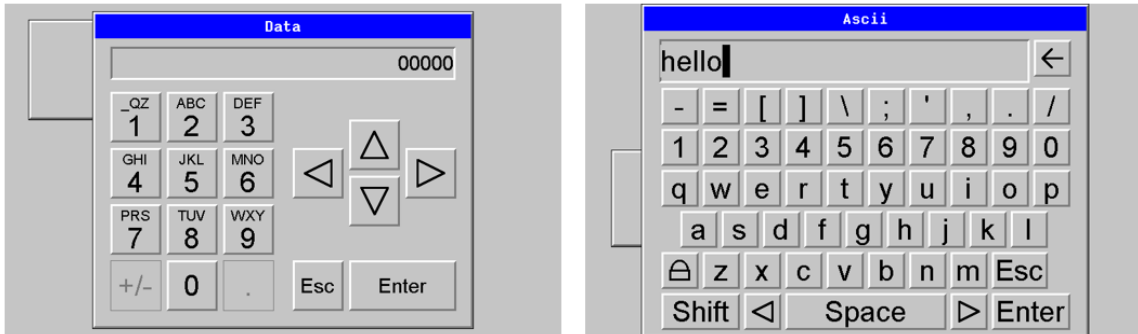

Once the desired value is entered, pressing the Enter key moves that value into the object (and the corresponding OCS register) and the alpha-numeric keypad disappears. Alternately, pressing the ESC key any time before the Enter key cancels the operation, leaves the objects current value unchanged, and the alpha-numeric keypad disappears.

NOTE: Each numeric entry object has a configured minimum and maximum value. If the operator enters a value outside of the configured range, the new value is ignored when Enter is pressed and the current object value is NOT changed.

Since the alpha-numeric keypad services several different graphical objects, certain keys on the alpha-numeric keypad may be disabled (grayed) when the keypad is invoked for certain objects. The following describes the alpha-numeric keypad variation based on object.

Alpha-Numeric Keypad Variations	
Numeric Object	When editing a numeric value, the [+/-] or the [.] key are disabled (grayed) if the object is NOT configured for floating-point value or a signed value.
Password Object	When editing a password value, the arrow keys, [+/-], and the [.] keys are disabled. Additionally, overwrite mode is disabled. When entering digits, the pop-up keypad hides the value by displaying "*" alternately for each digit.
ASCII Object	When editing an ASCII value, an ASCII keypad is displayed as shown Figure 14.2. The ASCII keypad has 3 modes: numeric, symbols and alpha. In Alpha mode, the Caps Lock button may be pressed to access capital letters. Typing a character will overwrite the entire old string and start a new entry. Press the backspace arrow to delete the previous character. Pressing Enter will save the entry, pressing ESC will cancel the edit and return the string to the previous value.
Text Table Object	When editing a Text Table Object, all the keys except the Up and Down arrow keys are grayed and disabled. The next text selection is made by pressing either the Up or Down arrow.
Time/Date Object	When editing a Time/Date Table Object, all the keys except the Up, Down, Left and Right arrow keys are grayed and disabled. The specific field (i.e. hour or minutes) is selected using the Left and Right arrows. The value in the selected field is changed by pressing either the Up or Down arrow.

Screen Navigation

To allow the operator to change screens, a Screen Jump Object is generally used. This object may be visually represented as a 3-D button (responding to touch) or remain invisible and logically tied to an OCS register. An optional system ICON may be configured for display along with the legend, which aids in identifying the object as one that causes a screen change.

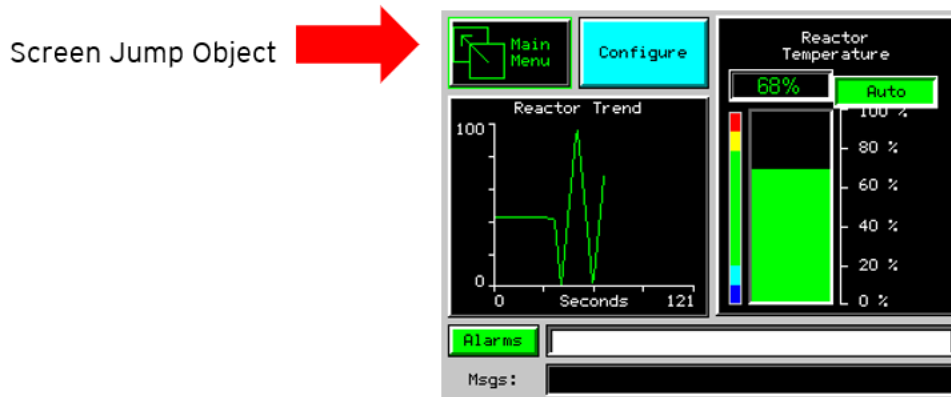

Ladder-Based Screen Navigation

Ladder logic can use several techniques to control screen navigation. Coils can be tied to %D registers to make them screen coils. These coils have two modes: switch and alarm. If the ladder program energizes an alarm display coil, the screen associated with this coil is displayed and overrides the normal user screens. This is designed to show alarm conditions or to display other ladder-detected events. When the text coil is de-energized, the previous screen that was being viewed before the alarm is returned.

The switch display coil switches to the associated screen when it is energized. Once it is de-energized, the screen remains until it is switched by the user or ladder.

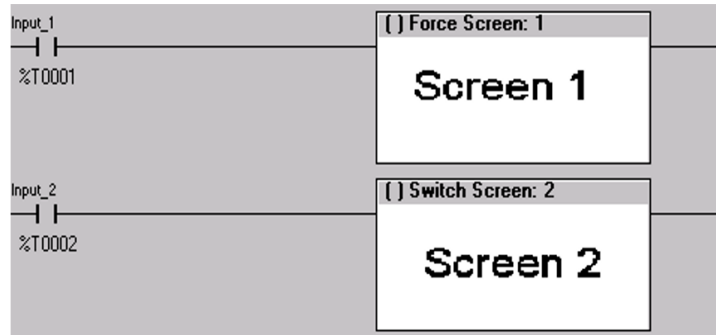

There is also a system register that can be used to for control-based screen navigation. %SR1 can be read to determine the current screen or written to change the current screen. Refer to the On-Line help in Cscope for more information on control-based screen navigation.

Beeper Acknowledgement

The EXL6/XL6 Prime contains an internal beeper that provides an audible acknowledgment when an operator touches a graphic object that accepts touch input. When the graphic object is enabled, a short 5ms tone is emitted. When the graphic object is disabled, a longer 100ms tone is emitted to announce that the graphical object is not currently accepting the touch input.

If beep acknowledgement is not desired, the beeper function can be disabled from the **System Menu**.

Touch (Slip) Sensitivity

Touch slip sensitivity is preset to meet most applications; however, adjustment is available to reduce the sensitivity for touch release. That is, once a graphical object (button) is touched and held by a finger, the default touch slip sensitivity allows for a slight slip of the finger on the graphical object before the EXL6/XL6 Prime assumes touch been released (equates to approximately a quarter inch of movement with a stylus).

In some applications (such as jog buttons) where the operator is pushing a button for a period of time, the amount of slip while holding a button pressed may exceed the default sensitivity. To increase the amount of tolerable slip and prevent false releases of the button, the EXL6/XL6 Prime allows adjustment of the allowable slide up to 5x the default value.

To enable the touch (slip) sensitivity, first an OCS data register must be allocated through the Graphics Editor Configuration menu for Display Settings. Once a Touch Sensitivity register is assigned, that register may be modified [range = 1 (Low) to 5 (High)] to the desired slide amount. If a value outside the valid range is entered in the touch sensitivity register, it is ignored, and the last valid value is used.

Alarms

Alarm presentation to the operator is highly configurable and beyond the scope of this document to describe fully. For more information, refer to the graphics editor help file in CSPACE. This section presents a typical configuration thereby providing an introductory description on what the operator should expect.

The alarm object is generally used to enunciate alarms to the operator. While the display characteristics of this object is configurable, it is generally displayed as a button that changes colors to indicate the highest state of the alarm(s) in the alarm group it is monitoring. The following indicates the priority of the alarm states and the default colors associated with these states.

Highest	(Red)	Unacknowledged Alarms Exist
–	(Yellow)	Acknowledged Alarms Exist
Lowest	(Green)	No Alarms Exist



To view, acknowledge and/or clear alarms, the operator must access the alarm viewer. This is accomplished by touching an (enabled) alarm object. When accessed, the alarm viewer is displayed as pop-up alarm viewer dialog.

Alarm Viewer

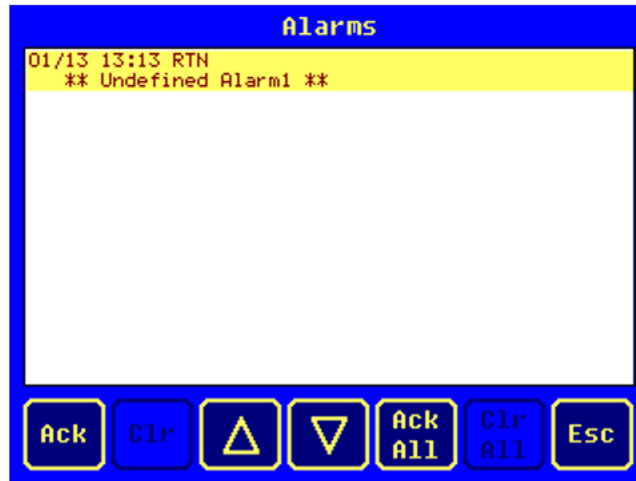

The currently selected entry is indicated by a yellow highlight which can be moved up or down by touching the arrow buttons or by directly touching an entry. If more entries exist than can fit on the page, a scroll bar is displayed on the right side that also indicates the current relative position.

The current state of the displayed alarm is indicated by its color and optionally by an abbreviated indicator after the date/time stamp (ALM, ACK, RTN). The operator can acknowledge an alarm by selecting it from the list and touching the ACK button. The operator can also clear an alarm if that function is enabled in the alarm object. If not enabled, the Clear buttons are grayed and do not respond to touch. Once view operations are complete, simply touch the Esc button to remove the pop-up alarm viewer.

NOTE: OCS registers %SR181 and %SR182 are available for ladder use, which indicate presence of unacknowledged or acknowledged alarm (respectively). The screen designer may implement these registers to switch screens or activate the beeper to attract the operator's attention.

Removable Media

The Removable Media Object is generally used to inform the operator on the current state of the removable media device and allow access to its file structure. The Removable Media Object is displayed as a button that changes colors to indicate the current state of the removable media device. The following indicates the device states and the default colors associated with these states.

Highest	(Red)	Device Error
-	(Yellow)	Device Full (threshold adjustable)
Lowest	(Green)	Device OK

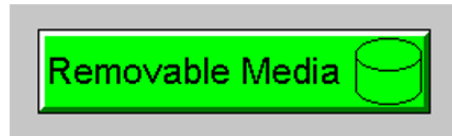

To view and perform file operations, the operator must access the removable viewer. This is accomplished by either touching an (enabled) removable media object or through the System Menu. When accessed, the removable media viewer is displayed as pop-up removable media dialog.

NOTE: The Removable Media Object can be configured to open the removable media viewer at a certain directory complete with restrictions on transversing back up the file path. This may be used to restrict operator access to non-critical files.

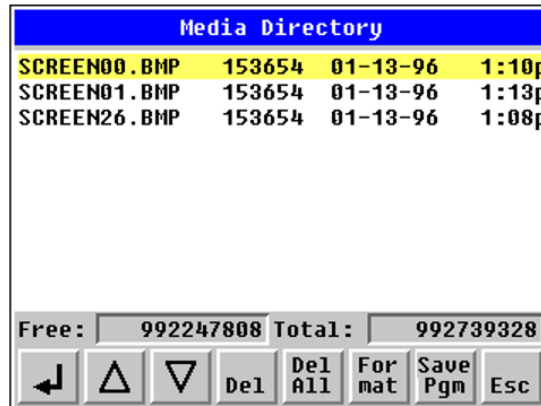

The currently selected entry is indicated by a yellow highlight which can be moved up or down by touching the arrow buttons or by directly touching an entry. If more entries exist than can fit on the page, a scroll bar is displayed on the right side that also indicates the current relative position.

File operations are accomplished by pressing the appropriate button at the bottom of the Removable Media Viewer. The configuration of the removable media object that invokes the Removable Media Viewer defines what buttons are enabled and available to the user. A button is grayed and does not respond to touch if configured as disabled.

The  (Enter) button (if enabled) performs certain operations based on the selected file's type:

- .. Change display to parent directory
- <DIR> Change display to child directory
- bmp, jpeg Display bitmap (if compatible format)
- pgm Load application (if compatible model and version)

Alternately, the (enter) button can be configured to simply load the ASCII representation of the file path (including the file name) to a group of OCS registers. That pathname can then be used by ladder for opening and manipulating that file.

Once view operations are complete, simply touch the Esc button to remove the pop-up removable media viewer.

If the removable media is used in an application, the Removable Media Device requires changing by the operator, and the application is attempting to write to the removable media when it is removed, the screen designer should create objects that allow the operator to temporarily halt access to the removable media. This prevents corruption to the file system if the removable media is removed during a file-write sequence. The graphic objects should set OCS register %SR174.1 (when requesting the card be removed) and provide an indicator based on OCS register %SR174.2 (which indicates that it is safe to remove the removable media).

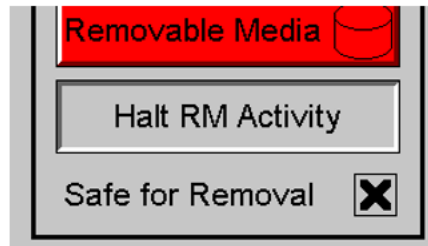

Screen Saver

The EXL6/XL6 Prime screen backlight life is typically five (5) years when in continuous use. If the application does not require interaction with the EXL6/XL6 Prime for long periods of time, the backlight life can be extended by using the screen saver function. When enabled through the System Menu, the backlight is shut off (screen goes black) after a specified time of no touch activity on the screen. When the screen saver shuts off the backlight, any operator touch on the screen or function keys reactivates the backlight.

NOTE: When the screen saver is active (backlight shut off), any initial touch activity on the screen (or function key) to reactivate the backlight is otherwise ignored by the EXL6/XL6 Prime. Any additional touch activity is also ignored by the EXL6/XL6 Prime for approximately one second thereafter.

It is possible for the application to temporarily disable the screen saver by generating a positive transition to %SR57.16 (coil only) at a rate faster than the screen saver timeout value. This may be desired while waiting for alarm acknowledgement.

Screen Brightness

The EXL6/XL6 Prime provides a feature that allows screen dimming for night operation. To enable this feature, the application must access and control system register %SR57 (Display Backlight Brightness). Screen brightness is continuously variable by driving %SR57 through the range of 100 (full bright) to 0 (full off). It is left to the screen designer on if and how to present a Screen Brightness control to the user.

NOTE: The backlight life can be extended by dimming or powering off the backlight.

Touch Screen Pressure

The Horner XL series OCS controllers have a resistive touch screen that allows mechanically detecting touch events. The resistive touch screen works by measuring the resistance between two layers of conductive film.

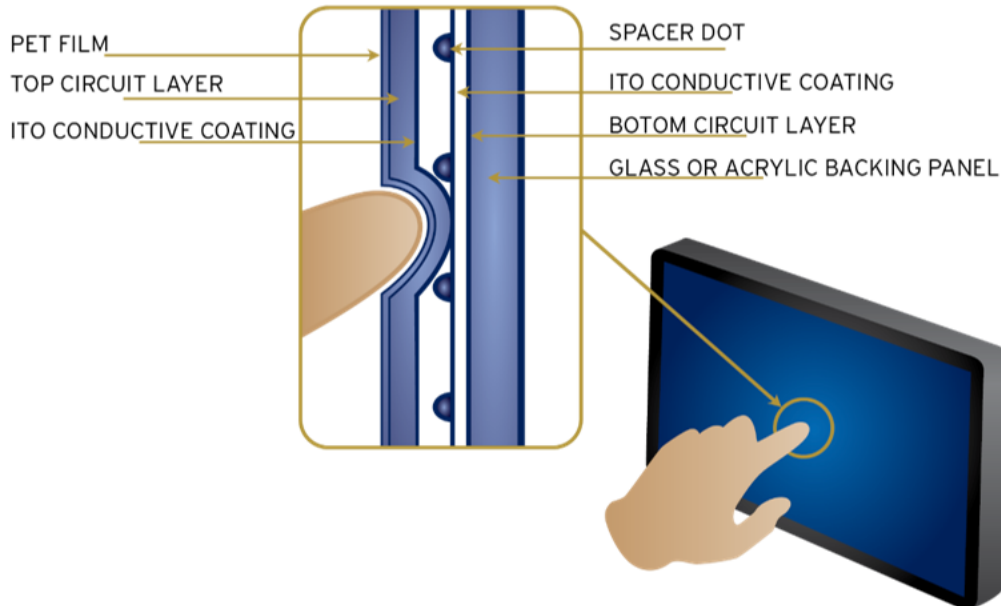

NOTE: Touch creates contact between resistive circuit layers, closing a switch.

With a unique change to the touch monitoring firmware user can measure the pressure being exerted on the touch screen. This feature has been added in some Horner XL series controllers. This allows the OCS programmer to be notified of the touch pressure and it can configure the pressure required to accept a touch event.

There are two system registers that provide this touch feature:

- **%SR9 (I/O Name - TCH_PRESSURE)** - Records the highest-pressure level of the last touch on the screen that exceeds the threshold value set in %SR10. This is a range of 0 to 3000. Zero (0) indicates no pressure and 3000 is the maximum amount of pressure that can be measured.
- **%SR10 (I/O Name - TCH_PRESSURE_TSH)** - This register sets the pressure threshold to indicate a touch. A value of 200 is typically the lightest touch, 600 is moderate and 1000+ is a heavy touch.

These new features allow customizing the feel of the touch screen and can be used to add unique user interface features such as having different operations depending on the force of the touch.

Video Object



Video Object

Video Object Overview	152
Opening Video Object in Cscope	153
Video Properties Configuration	155
Video Object Performance	157
Web Cameras	157

Video Object Overview

The Video Object feature allows two options for video type: Stream and Playback. The Video Object trigger is used to start, stop, and pause video, and the System Register provides the status of the video object, which supports various resolutions and frames per second.

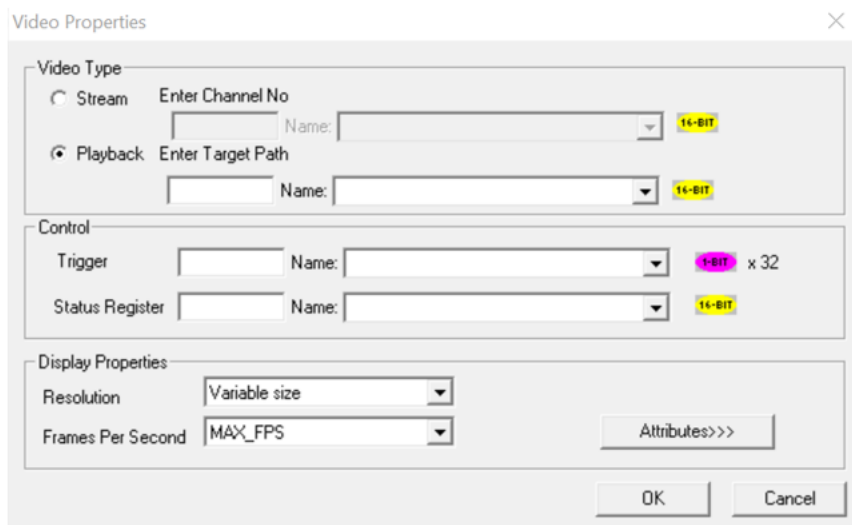

Specifications of Video Properties	
Streaming Channels	4 channels supported through USB hub
	1 channel can be viewed at a time
Playback Formats	.mp4
	.mov
	.mpg
	.wmv
Resolution	320x240 (QVGA)
Frames per Seconds	10, 15, 20, 24, 30 & MAX_FPS

Opening Video Object in Cscape

NOTE: For Cscape 10 please refer to the Help File.

In Cscape, select the OCS and model number by selecting **Controller > Hardware Configuration** from the toolbar.

1. Open the Graphics Editor by selecting the “T” button from the toolbar.



2. In the Graphics Editor, select the video button from the toolbar.

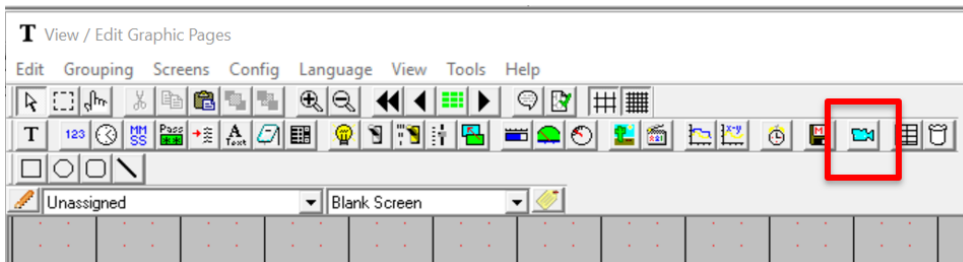

3. Click in the grid.

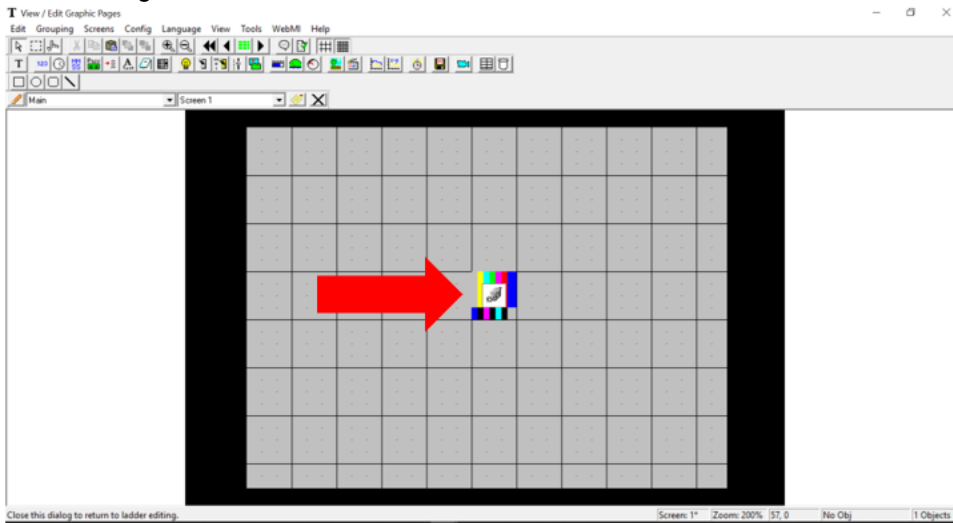

4. Then double click on the icon in the middle to open the Video Properties dialog.

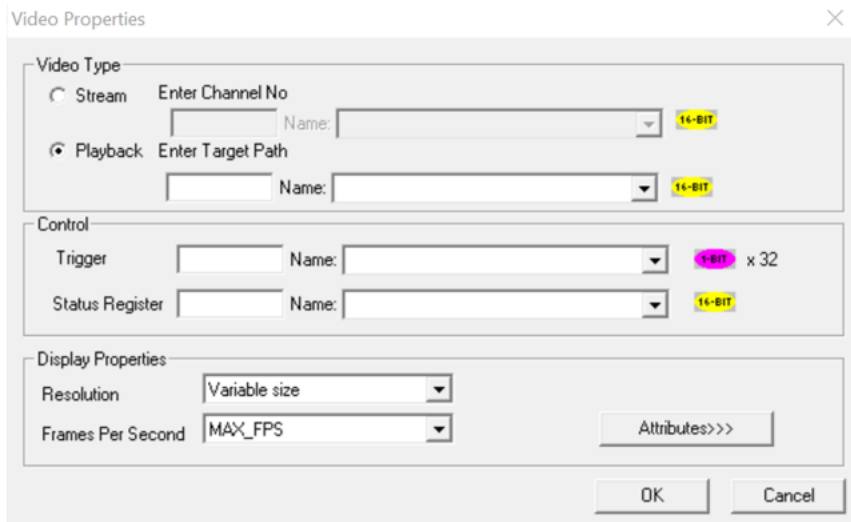
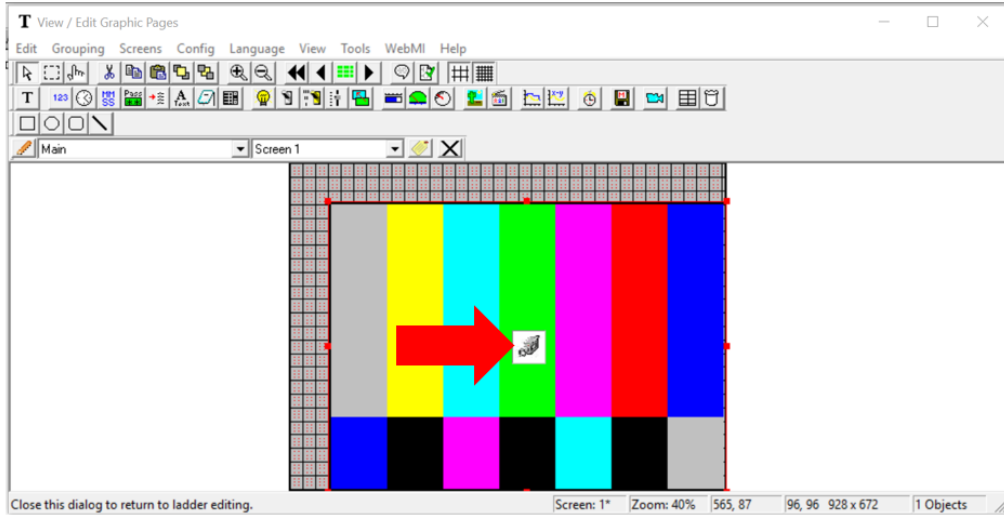

Video Properties Configuration

Video Type

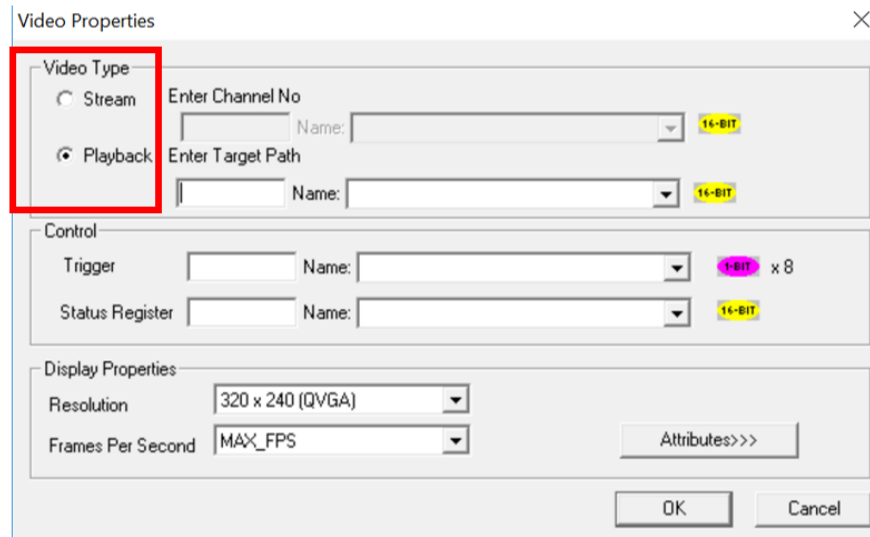

There are two options for video type: **Stream** and **Playback**.

Stream – This option can be selected to view live video from a web cam. Four channels are supported through the USB hub. Only one channel can be viewed at a time. Enter Channel Number directly or through registers in the Enter Channel No field.

Playback – This option can be selected to view videos that are stored in Removable Media on the controller. Videos present in both A (microSD) and B (USB) drives are supported and can be viewed. Supported formats including .mp4, .mov, .mpg, and .wmv, can be played.

Select **Playback** and enter video name in the Enter Target Path field either directly or through registers.

For example: Test1.mp4 (from microSD) or B:\Test2.mp4 (from USB).

Control

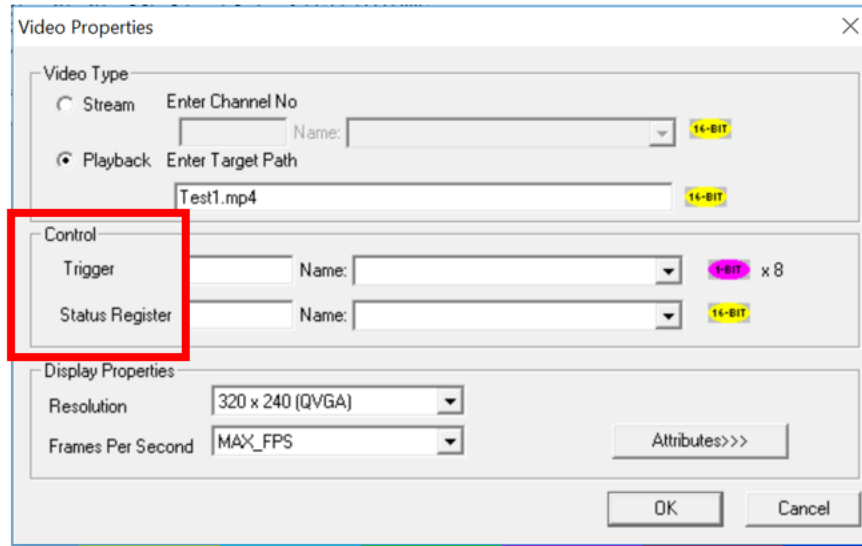

Trigger - The video control trigger is used to start, stop and pause video. Video trigger is done by bit level addressing. The trigger reserves eight (8) bits and uses the first two (2) bits.

NOTE: The least significant bit is Bit 1.

Bit 1	High = Start Low = Stop
Bit 2	High = Pause Low = Play

System Register - The Video Control System Register provides the status of the Video Object. The status word is 16-bits and should be viewed in hexadecimal format.

0x0001	Video is currently playing
0x0002	Video is paused
0x00010	Channel number cannot be greater than 4
0x0020	File not present or corrupted
0x0040	Frame per second not supported or not compatible

Configuring Display Properties

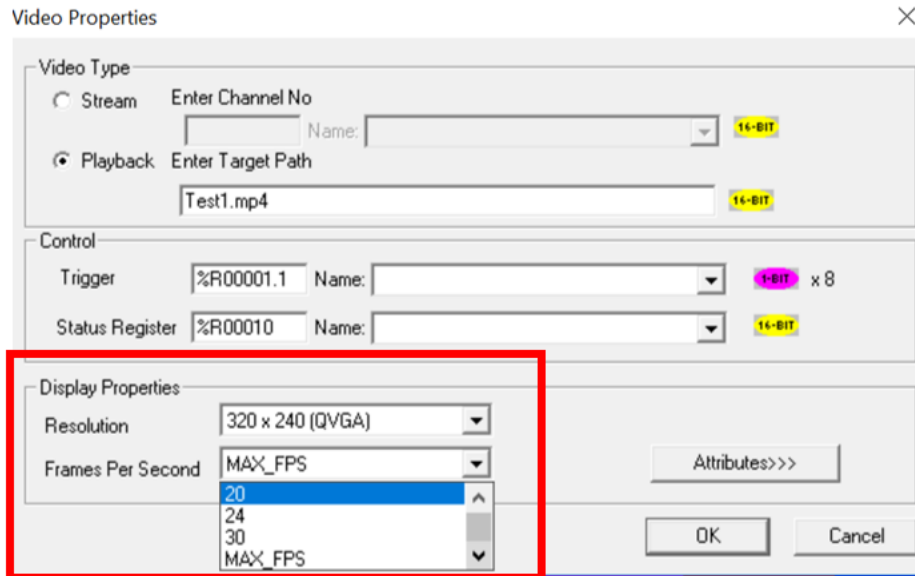

Resolution Options	320x240 (QVGA)
Frames per Seconds	10, 15, 20, 24, 30 & MAX_FPS

Video Object Performance

1. When Video Object is active, navigating to System Menu or any popup window, causes Video Object to be inactive.
2. Video Object can be made active in both Idle and Run modes.
3. If actual Frames Per Second of the configured video is different from the one that is configured in Cscape, few frames will be missed when video is played.

Web Cameras

If multiple web cameras are directly connected to the OCS, then only one web cam will be considered. If user needs to connect multiple web cams, USB hub needs to be used. A maximum of four channels (web cameras) are supported.

Removable Media



Removable Media

microSD Cards	159
Using the Removable Media Manager	160
Log Data	160
View and Capture Screens	161
Removable Media Object	161
Function Blocks in Cscape	162
Filenames	163
System Registers used with RM	163

All Horner controllers models provide a Removable Media slot, labeled Memory Card, which supports standard microSD flash memory cards. microSD cards can be used to save and load applications, to capture graphics screens and to log data for later retrieval.

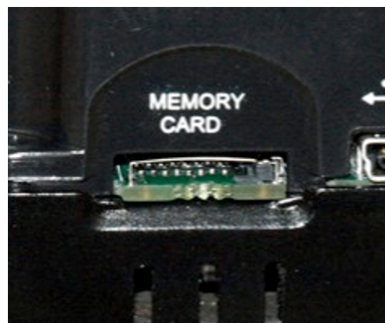

microSD Cards

When the microSD card format was introduced, it was originally called TransFlash. Cards labeled either microSD or TransFlash, with up to 32GB of flash memory, are compatible with the Horner controller Memory Card slot.

The Memory Card slot is equipped with a “push-in, push-out” connector and a microSD card can be safely inserted into the Memory Card slot whether the Horner controller power is On or Off.

- To install a microSD card: Align its 8-pin gold edge connector down, facing the front of the Horner controller unit as shown below; then carefully push it all the way into the Memory Card slot. Ensure that it clicks into place.
- To remove the microSD card: Push down on the top of the card gently to release the spring. The card pops up for removal.

microSD File System

The microSD Memory Card slot uses the PC-compatible FAT32 File System. This means that a PC, with a microSD-compatible card reader, can read files that have been written by the Horner controller and can write files that can be read by the Horner controller.

However, the Horner controller does not support long filenames, but instead implements the 8.3 filename format. This means that all file and directory names must consist of up to eight (8) characters, followed by an optional dot, and an optional extension with up to three (3) characters.

Directories and sub-directories can be nested up to 16 levels deep as long as each path name string does not exceed 147 characters.

Using the Removable Media Manager

The Removable Media Manager is an interactive Horner controller screen that performs the following functions:

- a. Display number of total and free K bytes
- b. Browse file and directory lists
- c. Delete files and directories
- d. Format a microSD card
- e. Load and save application programs
- f. View screen capture bitmaps

The Removable Media Manager can be accessed via the System Menu or by using Cscope to place a Removable Media Manager object on an application graphics screen.

Media Directory				
SCR0000	.JPG	26267	07-10-08	12:46
SCR0001	.JPG	14272	07-10-08	12:46
SCR0002	.JPG	15209	07-10-08	12:46
SCR0003	.JPG	29708	07-10-08	12:46
SCR0004	.JPG	29582	07-10-08	12:47
SCR0005	.JPG	23263	07-10-08	12:47
SCR0006	.JPG	14643	07-10-08	12:47
SCR0007	.JPG	14976	07-10-08	12:47
SCR0008	.JPG	15994	07-10-08	12:47
SCR0009	.JPG	17561	07-10-08	12:47
Free:		511672320	Total:	511959040
←	△	▽	Del	Del All
			For	Save
			mat	Pgm
				Esc

Log Data

Using Read and Write Removable Media function blocks, an application ladder program can read and write Horner controller register data in the form of comma-delimited files, with a .csv extension. These files are compatible with standard database and spreadsheet PC programs. In addition, an application ladder program can use Rename and Delete Removable Media function blocks to rename and delete files.

View and Capture Screens

The Horner controller File System uses bitmap files with the .BMP extension or JPEG files with the .JPG extension to store Horner controller graphic screen captures.

To view a captured Horner controller screen, use the Removable Media Manager to find and highlight the desired .BMP or .JPG file, and then press Enter. 

To capture an Horner controller screen, turning on the assigned **Screen Capture Control Register** will capture the current Horner controller graphics screen and write it to the microSD card using the assigned **Screen Capture Filename**.

Before capturing an Horner controller screen, Cscape must first be used to assign a **Screen Capture Control Register** and Filename in the application. To do this, first open the Graphics Editor by selecting the **View > Edit Screens** item on the **Cscape Screens** menu. Next, select the **Screen Capture** item of the **Graphics Editor Config** menu and then enter a Control Register and Filename.

To capture an Horner controller screen, turning On the assigned **Screen Capture Control Register** will capture the current Hornercontroller graphics screen and write it to the microSD card using the assigned **Screen Capture Filename**. To view a captured Horner controller screen, use the Removable Media Manager to find and highlight the desired .BMP or .JPG file, and then press Enter.

Removable Media Object

The configuration of the Removable Media Object that loads the Removable Media Viewer defines what buttons are enabled and available to the user.

The  (Enter) button (if enabled) performs certain operations based on the selected file's type:

- .. Change display to parent directory
- <DIR> Change display to child directory
- pgm Load application (if compatible model and version)

Alternately, by checking the 'Write Selected Filename' option, the RM Manager object will load the currently displayed path and filename into a block of registers for use with other Removable Media functions. The register block is assigned in the 'File Select' config found in the Config menu of the graphic/screen editor.

Once view operations are complete, simply touch the Esc button to remove the pop-up removable media viewer.

Function Blocks in Cscape

NOTE: For detailed information regarding RM function blocks and parameters, refer to the Help File in Cscape Software. Refer to 'USB flash Media support for RM Functions' for USB flash drive access details.

The following RM functional blocks are available in Cscape Software. These function blocks will reference:

- a. microSD when filename is prefixed with 'A:' or nothing
- b. USB A flash drive when filename is prefixed with 'B:'

Read RM csv	Allows reading of a comma-separated value file from the microSD interface into the controller register space.
Write RM csv	Allows writing of a comma-separated value file to the microSD interface from the controller register space.
Rename RM csv	Allows renaming a file on the RM card. The data in the file is not changed.
Delete RM csv	Allows deleting a file on the RM card
Copy RM csv	Allows copying a file on the RM card. The data in the file is not changed.

Program Features

- a. **Datalog Configuration** - This feature allows the controller to periodically log register values to Removable Media. The register data is stored in .csv (comma separated value) format, which is compatible with 3rd party PC applications, such as Microsoft Excel.
- b. **Report Editor** - This feature allows the OCS to be configured to generate text printouts which incorporate data from the registers embedded in the text. The reports can be printed using a serial interface printer through any of the serial ports of the OCS or can be saved on the removable media of the device.
- c. **Recipes Editor** - Recipes allow the user to send or update multiple registers simultaneously.

Graphic/Screen Editor

- a. **Trends** - The historic support feature in the trend object utilizes Removable Media.
- b. **Removable Media** - This is a graphic object used to access files and functions pertaining to Removable Media.
- c. **Recipes** - This is a graphic object that is used in conjunction with the recipe editor which is mentioned above.

Additional Configuration

- a. **Alarms** - Alarm data can be logged to a .csv file stored on Removable Media.
- b. **Screen Capture** - The screen capture function allows a bitmap or jpeg image of the displayed OCS screen to be written to the Removable Media card.
- c. **Filename Counters** - The filename counters can be accessed wherever Removable Media functions require a path name. A typical application is the auto-incrementing of a file name when doing screen captures.
- d. **File Select** - File Select is used to specify the register block that is used with the Removable Media Manager object 'Write Selected Filename' option.

Filenames

The RM function blocks support the flash with a Windows standard FAT-16 file system. All names must be limited to the “8.3” format where the filename contains eight characters a period then a three-character extension.

The entire filename including any path must be less than or equal to 147 characters.

When creating filenames and directories, it is sometimes desirable to include parts of the current date or time. There are six special symbols that can be entered into a filename that are replaced by the OCS with current time and date information.

Filename Special Symbols		
Symbol	Description	Example
\$Y	Substitutes the current 2-digit year	2015 = 15
\$M	Substitutes the current month with a 2-digit code	March = 03
\$D	Substitutes the current day	22nd = 22
\$h	Substitutes the current hour in 24-hour format	5 pm = 17
\$m	Substitutes the current minute	45 = 45
\$s	Substitutes the current second	34 = 34

NOTE: All the symbols start with the dollar sign (\$) character. Date symbols are in upper case, time symbols are in lower case.

The following are examples of the substituted time/date filenames:

Current date and time: March 1, 2015 5:45:34 PM

Filename: Data\$M\$D.csv = Data0301.csv

Filename: Year\$Y\Month\$M\aa\$D_\$h.csv = Year15\Month03\aa01_17.csv

Filename: Month_\$M\Day_\$D\h_\$m_\$s.csv = Month_03\Day_01\17_45_34.csv

System Registers used with RM

%SR174 – Removable Media Protect. Write a one (1) to %SR174 to prohibit read/write access to the removable media card. Write a zero (0) to allow access.

%SR175 Status – This shows the current status of the RM interface.

%SR176 Free Space – This 32-bit register shows the free space on the RM card in bytes.

%SR178 Card Capacity – This 32-bit register shows the total card capacity in kilobytes.

Possible status values are shown in the table:

RM Status Values	
0	RM interface OK
1	Card present but unknown format
2	No card in slot
3	Card present, but not supported
4	Card swapped before operation was complete
5	Unknown error

Clone Unit



Clone Unit

Make Clone	165
Load Clone	167

'Clone Unit' feature allows the user to "clone" the OCS of the exact same model. This feature "clones" application program and unit settings stored in battery-backed RAM of an OCS into the RM. Refer to "Removable Media" on page 159 for more details. It can then be used to clone a different OCS (exact same model).

This feature can be used for:

- Replacing an OCS by another unit of the same model.
- Duplicating or "clone" units without a PC.

Make Clone

The user needs to perform the following to Clone:

Step 1: The 'Clone Unit' can be accessed by going to the 'System Menu' of the OCS. A new menu "Clone Unit" has been added at the end of the main System Menu as shown below:

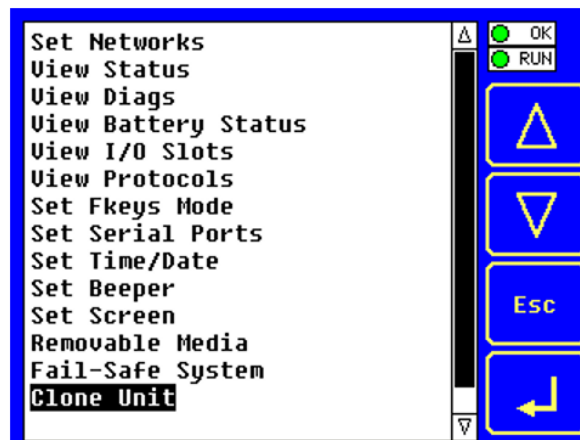

Step 2: Selecting “Make Clone” will open the following menu screen. **NOTE:** Free/Total – displays number of free and total bytes in Removable Media.

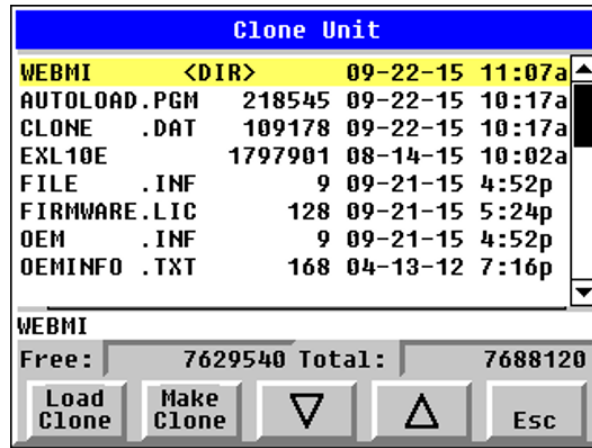

Make/Create Clone option enables user to duplicate / Clone application file, all unit settings and all register values from battery-backed RAM. Selecting Make Clone brings up the screen below for the user:

Make/Create clone can also be triggered by setting %SR164.9 bit to “1” from Ladder program or graphics. Once the operation is completed, this bit is made zero by the firmware. When Make Clone operation is triggered by this SR bit, it does not ask the user for confirmation for making clone. The success / failure of the operation is also not notified on screen to the user.

In case of failure of “Make Clone” operation, %SR164.11 bit is set to “1” by the firmware and never reset.

NOTE: Backup of registers in flash memory is not performed by Clone Feature. Refer to "Fail-Safe System" on page 1.

Load Clone

This option loads the application, all unit settings and register values from Removable media to the battery-backed RAM (Regardless of AutoLoad settings) and then resets the OCS for the settings to take effect.

User needs to perform the following to Load Clone:

Step 1: Select “Clone Unit” from main System Menu of OCS as shown below:

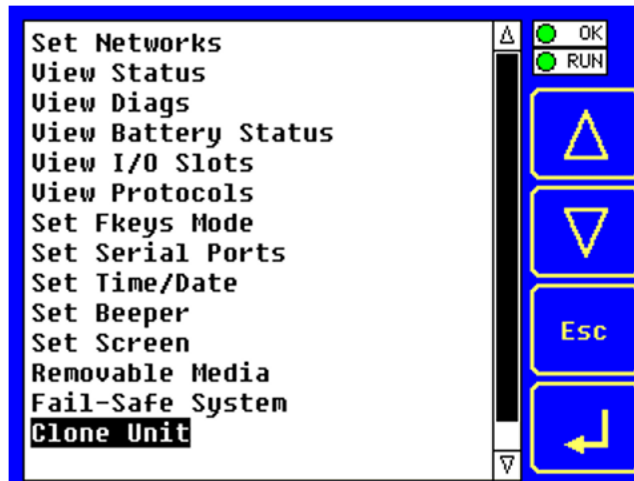

Step 2: Selecting “Clone Unit” menu will open the following menu screen. Select “Load Clone”.

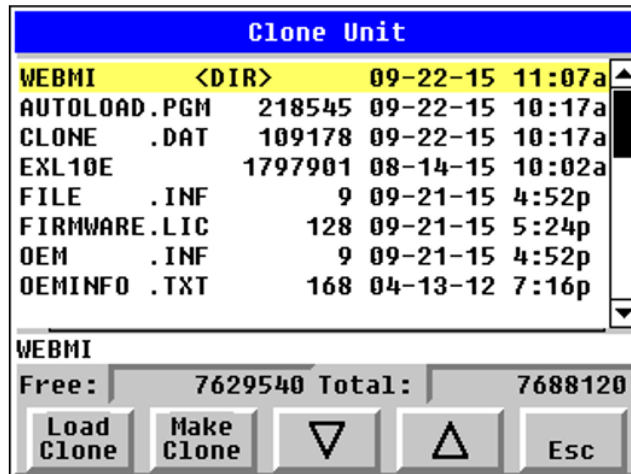

NOTE: For security enabled files, Load clone asks for password validation before loading the application.

Load Clone can also be triggered by setting %SR164.10 bit to “1” from Ladder program or graphics. Once the operation is completed, this bit is made zero by the firmware. When Load Clone operation is triggered by this SR bit, it does not ask the user for confirmation for loading clone. The success / failure of the operation is also not notified on screen to the user.

In case of failure of “Load Clone” operation, %SR164.12 bit is set to “1” by the firmware and never reset.

Fail-Safe System



Fail-Safe System

For the XL & X Series	169
For the XL Prime Series	169
Fail-Safe System Overview	170
Settings	170
Backup / Restore Data	171
Clear Backup Data	172
AutoLoad	174
AutoRun	176

For the XL & X Series

The Fail-Safe System is a set of features that allow an application to continue running in the event of certain types of "soft" failures. These "soft" failures include:

- Battery power loss
- Battery-Backed Register RAM or Application flash corruption due to, for example, an excessive EMI, Electromagnetic Interference, event.

For the XL Prime Series

The Fail-Safe System is a set of features that allow an application to continue running in the event of certain types of "soft" failures. These "soft" failures include:

- Retentive Register or Application flash corruption due to, for example, an excessive EMI, Electromagnetic Interference, event.

Fail-Safe System Overview

The Fail-Safe System has the following capabilities:

- Manually backup the current Retentive Register Settings into flash memory.
- Manually restore Register Settings from the values previously backed up in flash memory to battery-backed RAM.
- Detect corrupted Register Settings at power-up and then automatically restore them from flash.
- Detect corrupted or empty application in flash memory at power-up and then automatically load the AUTOLOAD.PGM application file from Removable Media (Compact flash or microSD).
- If an automatic Register Restore or Application Load occurs, the OCS can automatically be placed in RUN mode.

The fail-safe system can be accessed by going to the System Menu of the controller. A new menu “Fail-Safe System” has been added at the end of the main System Menu for this. Selecting “Fail-Safe System” menu will open the following menu screen:

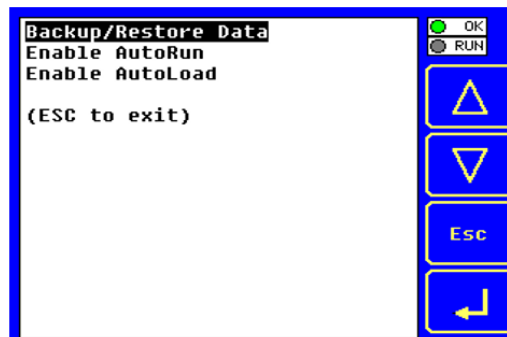

Settings

To use the Fail-Safe feature, the following steps are required:

- From Cscape, create AUTOLOAD.PGM for the application program using 'Export to Removable Media'.
- Place the Removable Media with AUTOLOAD.PGM in the device.
- Set the 'Enable AutoLoad' option in the device to YES.
- Set the 'Enable AutoRun' option to YES if the controller needs to be placed in RUN mode automatically after automatic restore of data or AutoLoad operation.
- Backup the current battery-backed RAM Register contents in onboard flash memory using System Menu options.

Backup / Restore Data

Selecting this option brings up a screen having four operations:

- Backup OCS Data.
- Restore OCS Data.
- Clear Backup Data.
- Exit



Backup OCS Data

When initiated, this will allow the user to manually copy battery-backed RAM contents on to the onboard flash memory of the OCS. This will have the effect of backing up all the registers and controller settings (Network ID, etc.) that would otherwise be lost due to a battery failure.

%SR164.4 is set to 1 when backup operation is performed.



Restore OCS Data

When initiated, this will allow the user to manually copy the backed-up data from the onboard flash to the battery-backed RAM.

A restore operation will be automatically initiated if 1) a backup has been previously created and 2) on power-up the battery-backed RAM registers fail their check.

The following steps are required:

1. Place the controller in IDLE mode.
2. Copy data from onboard flash memory to OCS battery-backed RAM
3. Reset the Controller.
4. Put the controller in RUN mode if the AutoRun setting is 'Yes', or else it will remain in IDLE mode.



%SR164.3 is set to 1 only when an automatic restore operation is performed, not on a manual one. This bit is reset to the value of "0" when a new backup is created.

Restoring of data can be manually performed by selecting RESTORE option from the Backup / Restore Data menu. This will cause the controller to reset.

Clear Backup Data

When initiated, the backup data will be erased from the onboard flash and no backup will exist. %SR164.4 and %SR164.3 is reset to 0 when backed up data is erased.



Exit: Goes back to the previous screen.

The OCS follows the following sequence in execution of Automatic Restore:

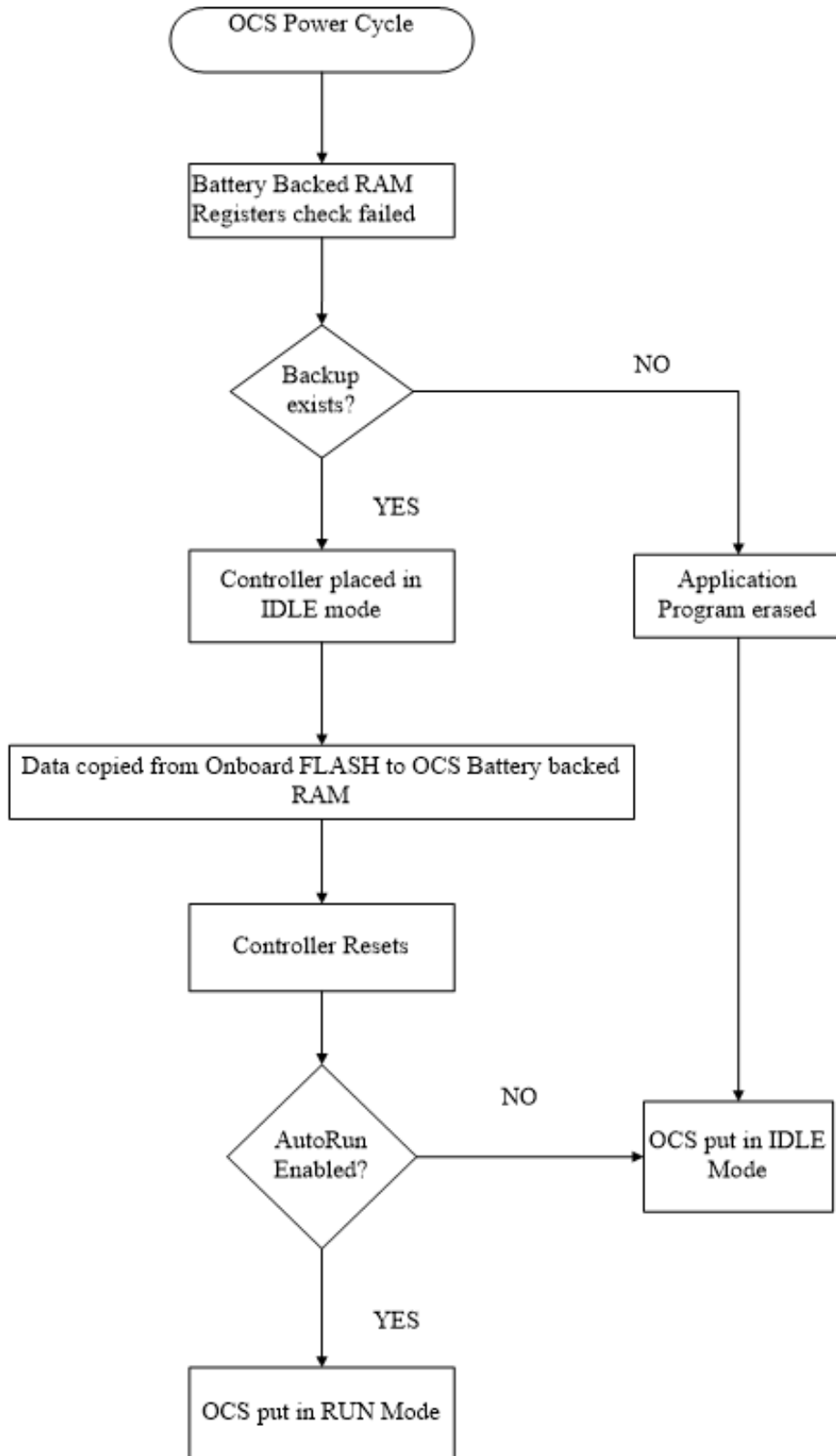

AutoLoad

This System Menu option allows the user to specify whether the OCS automatically loads the application AUTOLOAD.PGM located in Removable Media.

When the AutoLoad setting is enabled (set to YES), it can either be manually initiated or automatically initiated at power-up.

The automatic initiation will happen only in the following two cases:

- When there is no application program in the OCS and a valid AUTOLOAD.PGM is available in the removable media of the device.
- When the program residing in onboard memory is corrupted and a valid AUTOLOAD.PGM is available in the removable media of the device.

AutoLoad can be manually initiated when the SYS-F3 key is pressed (OCS can be in any of the following mode – Idle / Run / DOIO). This also requires a valid AUTOLOAD.PGM to be present in the removable media of the device.

When the AutoLoad setting is not enabled (set to NO), OCS will be in IDLE mode and the application is not loaded.

If the AUTOLOAD.PGM is security enabled, the user will be prompted to enter the password before loading the application. The application will be loaded from the Removable media only after getting the correct password.

%SR164.6 can be set to enable AutoLoad feature.

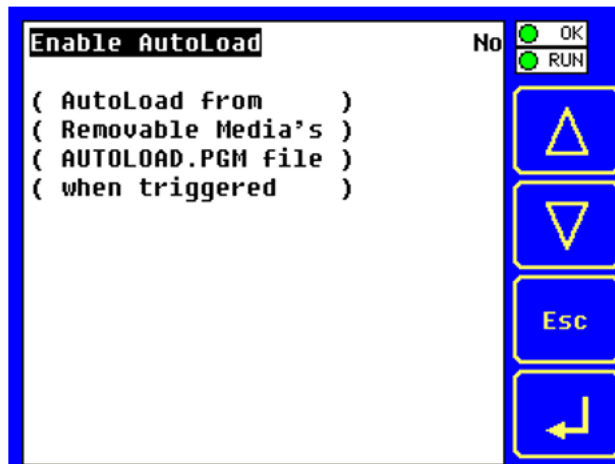

Enable AutoLoad	<p>No = Does not load AUTOLOAD.PGM automatically when application program is absent or corrupted.</p> <p>Yes = Loads AUTOLOAD.PGM file automatically from Removable Media when application program is absent or corrupted.</p>
-----------------	--

The OCS follows the following sequence in execution of AutoLoad:

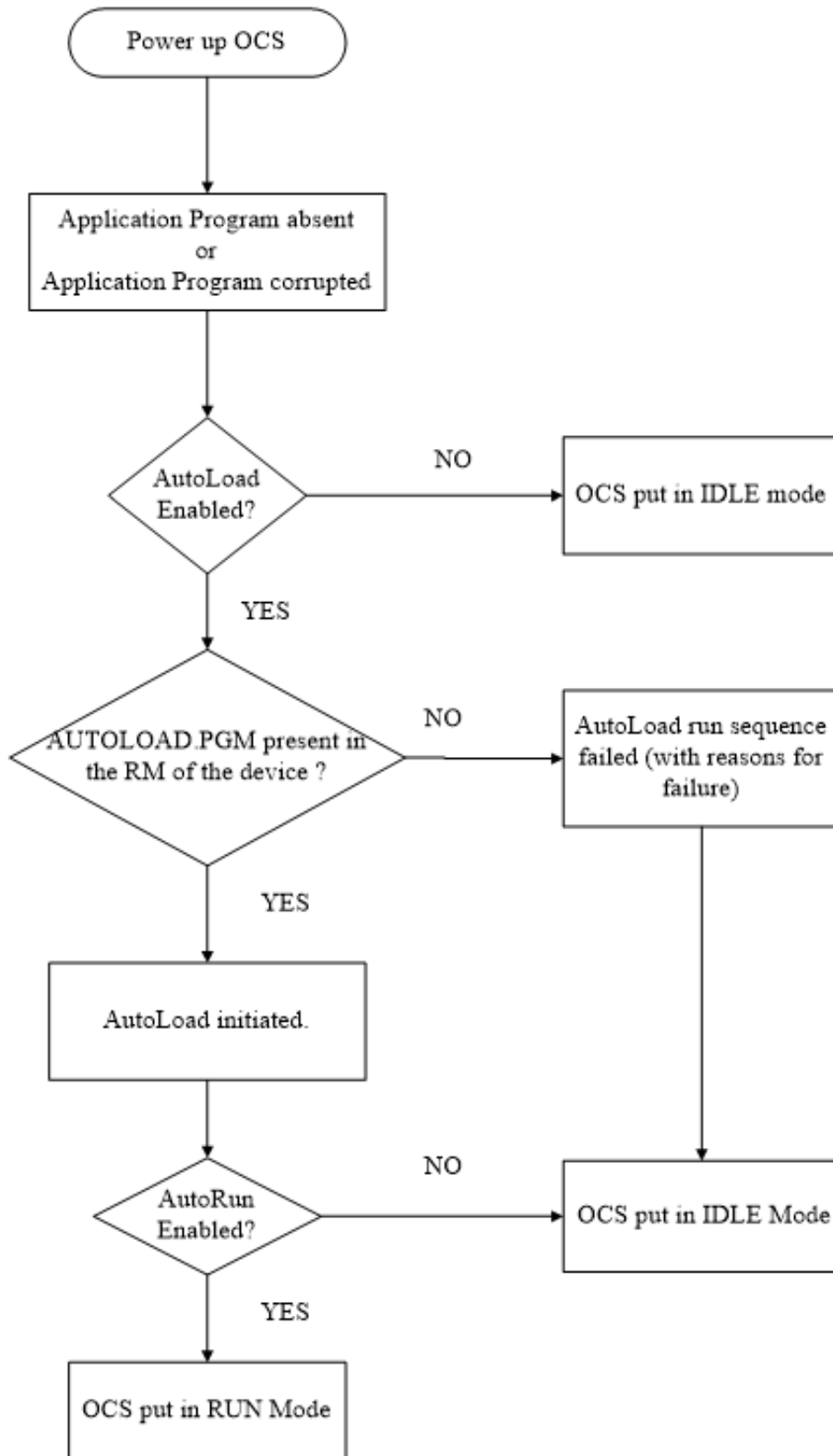

AutoRun

This System Menu option, when enabled (YES), allows the user to automatically place the OCS into RUN mode after the AutoLoad operation or automatic Restore Data operation.

When the AutoRun setting is disabled (NO), the OCS remains in the IDLE mode after a Restore Data or AutoLoad operation.

%SR164.5 can be set by putting the system into RUN mode automatically, once an AutoLoad has been performed or an Automatic Restore has occurred.

If for any reason the AutoLoad-Run (Loading the AUTOLOAD.PGM automatically and OCS put in RUN mode) sequence does not succeed, a pop-up message box saying "AUTO-LOAD-RUN SEQUENCE FAILED" will be displayed. It will also show the reason for its failure. On acknowledging this message box, the AutoLoad-Run sequence will be terminated, controller will return to the first user-screen and will be placed in IDLE mode.

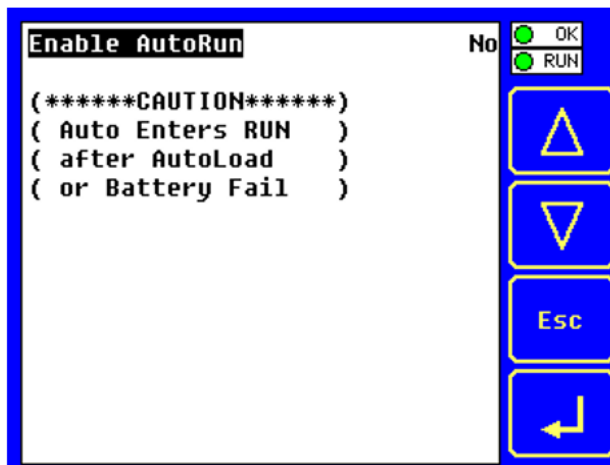

Enable AutoRun	No = OCS will be in IDLE mode after AutoLoad or Automatic Restore. Yes = OCS will automatically be placed into RUN mode after AutoLoad or Automatic Restore.
----------------	---

“Enable AutoLoad” displays the following options:

Enable AutoLoad	No = Does not load AUTOLOAD.PGM automatically when application program is absent or corrupted. Yes = Loads AUTOLOAD.PGM file automatically from Removable Media when application program is absent or corrupted.
-----------------	---

Modbus Communications



Modbus Communications

Modbus Slave Overview	178
Modbus Master Overview	179
Modbus Addressing Table	180

NOTE: For complete Modbus instructions, please refer to the Help file in Cscape.

Modbus (serial) is a popular, de-facto standard protocol that allows industrial devices from multiple manufacturers to easily share data in real-time. For Modbus serial communications, the EXL6/XL6 Prime can act as either a Master or a Slave.

Modbus protocol (serial) allows for one master and multiple slaves. The master always initiates the conversation by sending a request to a particular slave. Only the addressed slave will send a response when the request is completed. Should the slave be unable to complete the request, it returns the appropriate error response. Should the slave be unable to respond, the master's timeout timer expires to provide an indication of No Response.

Modbus Slave Overview

For complete Modbus Slave instructions, please refer to the Help file in Cscape.

The Modbus slave function block, when used with the appropriate Modem and/or Open Function Blocks, allows the primary serial port on the controller to act as a Modbus slave. The Modbus function supports both ASCII and RTU modes of operation across a range of baud rates and protocol frames. Also supported is port activity status, an inactivity timer, support for call-on exception, and support for store and forward (repeater) operation for radio modems.

The "Modbus Addressing Table" on page 180 section describes the supported Modbus Commands as well as the Modbus Map for EXL6/XL6 Prime References (%R, %M, etc.).

Modbus Master Overview

For complete Modbus Master instructions, please refer to the Help file in Cscape.

When acting as a Modbus master, there are two primary mechanisms used by the EXL6/XL6 Prime to allow the user to specify the data to be read/written from/to the slaves.

Modbus Master Function Block—This is for serial only. This is an advanced feature that should only be used in rare occasions.

Protocol Config—The Protocol Config is configured in the Hardware Configuration dialog box in Cscape (serial). Refer to the Modbus Addressing section. This is the preferred method in most applications.

After the protocol has been selected from the dropdown menu, the Network, Devices, and Scan List become available. The Protocol Config is configured on three different levels:

- **Network**—Parameters, such as the polling rate of the data scan, are specified along with timeout values, retry, and re-acquisition settings. Serial configuration, baud rate, parity, etc. are also set here.
- **Devices**—For every slave to be polled, configuration details are added in the Devices dialog box. This includes Slave ID (serial). Under Device Type, the Modbus addressing style matching that specified in the slave's user documentation may be selected. For instance, some slaves specify Modbus addresses (i.e. 40,001), and others specify offsets (i.e. 0000).
 - **Hex or Decimal**—Some specify addresses in hex, and others in decimal. By allowing the user to select the Modbus addressing style for each slave on the network, minimal address conversion is required. Also, if the slave is another Horner product (i.e. another OCS), the "Native Addressing" option can be selected (i.e. %R1, %M17, etc.), and this skips the conversion to Modbus style altogether.
- **Scan List**—This is where the specific Modbus addresses to be read/written from/to each slave are specified. Up to 32 words of data can be read at the same time.

NOTE: Once configuration has been completed on the Network and Devices level, Modbus data can be directly read/written from graphics objects in the Cscape screen editor. This is available even if the Modbus register is not listed on the scan list.

Modbus Addressing Table

To access EXL6/XL6 Prime registers, a Modbus Master must be configured with the appropriate register type and offset. This is usually accomplished with one of two methods:

Method 1: The first method uses Traditional Modbus References, in which the high digit represents the register type, and the lower digits represent the register offset (starting with Register 1 for each type). Since only four register types can be represented in this manner, EXL6/XL6 Prime Modbus Function Blocks pack several EXL6/XL6 Prime register types into each Modbus register type. Starting addresses of each EXL6/XL6 Prime register type are shown in the Traditional Modbus Reference column of the Modbus Table.

Method 2: The second method requires the Modbus Master to be configured with a specific Modbus Command and Modbus Offset. The supported Modbus commands and the associated offsets are also illustrated in Modbus Table.

EXL6 / XL6 Prime Modbus Master Mapping					
Reference	Maximum Range	Trad. Modbus Reference (5 Digits)	Expanded Modbus Ref. (6 Digits)	Modbus Command(s)	Modbus Offset
%I1	2048	10001	010001	Read Input Status (2)	0
%IG1	256	13001	013001		3000
%S1	256	14001	014001		4000
%K1	5	15001	015001		5000
%Q1	2048	00001	000001	Read Coil Status (1) Force Coil (5) Force Multiple Coils (15)	0
%M1	2048	03001	003001		3000
%T1	2048	06001	006001		6000
%QG1	256	09001	009001		9000
%AI1	512	30001	030001	Read Input Register (4)	0
%AIG1	32	33001	033001		3000
%SR1	256	34001	034001		4000
%AQ1	512	40001	040001	Read Holding Register (3) Load Register (6) Load Multiple Registers (16)	0
%R1	2488	40513	040513		512
%R1	2048	43001	043001		3000
%AQQ1	32	46001	046001		6000
%R1	9999	--	410001		10000

Rechargeable Battery for XL Series



EXL6 Rechargeable Battery

Storing Register Contents	182
Battery Life	182
Lithium Battery Safety	182
OCS Battery Charging Cycle	183
Battery Charging Status	184
Battery Status in System Registers	185
Safety & the Rechargeable Backup Battery	185
Steps to Replace the Rechargeable Battery	186

The EXL6 has an advanced battery system that uses a rechargeable lithium-ion battery. The battery powers the real time clock when power is removed, and it is needed for register data retention. **Does not include the EXL6 Prime.**

The following information pertains to the XL Series and RCC Series units. **This does NOT apply to the Prime Series.**

NOTE: For more details on the back-up battery, refer to the [Battery Manual](#) [MAN1142].

Storing Register Contents

The OCS controllers with rechargeable batteries write register data to high speed RAM when connected to DC power. When this power is lost, critical circuits switch over and run on batter power for about 1/10 of a second. During this time, register and other retentive data is saved away to flash memory. The clock continues to run on the battery at a much lower power. The battery is designed to last well over a year in this state. Once power is restored, the battery recharges in eight (8) hours or less.

Battery Life

The battery is designed to last 300 full charges to 1000 partial charge cycles or 7 to 10 years. Because typical operation does not drain the battery, the 1000 charge cycles should never be reached and the 7 to 10-year aging of the battery would limit its useful life. The battery is designed to be replaced.

Lithium Battery Safety

Many of the publicized battery issues are a result of using multiple batteries of flexible battery packs. The OCS uses a small, single cell in a metal enclosure. The battery is UL recognized and comes from quality suppliers. The OCS has safety circuitry built into the charging IC and additional external protection including fusing. These circuits were closely evaluated by UL and Horner engineering for use in hazardous environments.

OCS Battery Charging Cycle

There are various charging states that are executed based on battery temperature, level of battery charge, and self-test results. The battery temperature can be determined by checking the CPU temperature in the controller **System Menu >View Battery Status** or by monitoring **System Register %SR195**.

The battery temperature is equal to the CPU temperature minus 30°C.

NOTE: Refer to "Battery Charging Status" on the next page for charge states and definitions.

1. When power is applied to the OCS, the unit always goes to State 11; Waiting, for the first two minutes.
2. After two minutes have expired, the OCS will begin charging the battery based on battery temperature. In this step, charging will ensue even if the battery is already fully charged.
3. In this step charging does not ensue if the battery temperature is outside of the acceptable hot or cold limits.
4. The battery is charged fully to 4.2 volts in the Normal Charging or Cold Charging states or to 4.1 volts in the Hot Charging state.
5. Once fully charged to 4.2 volts, state 0, the Wait Discharging state is executed, state 12. The battery is allowed to discharge to 4.0 volts for however long that takes. Powering up the OCS will reset the charge cycle to step 1.
6. If the battery was charged to 4.1 volts under state 2, Hot Charging; 4.1 volts is maintained until Normal or Cold Charging can be executed.

NOTE: If the battery voltage is too low, less than 2.5 volts, or if the battery is missing, charging is suspended. In this condition, the OCS unit fails self-test. Diagnostics will show a battery warning. %SR55.13 will be ON.

NOTE: If the battery is not missing and the voltage is 2.5 volts or greater but will not fully charge in 8 to 40 hours, the charge cycle is suspended for 5 minutes and then tried again.

NOTE: Because the OCS is designed to maintain the Real Time Clock for a year or more in a powered down state, this translates as; the battery requires up to 8 to 40 hours of recharging time in a year.

Battery Charging Status

Viewed in the **System Menu > View Battery Status** or read as a numeric value in **%SR196**. The battery temperature, T_b , is equal to the CPU temperature minus 30°C: $T_b = CPU^\circ - 30^\circ C$.

Charging State Table			
%SR196	Name	Description	Additional Information
0	Final Charge to 4.2V	The battery is fully charged	Next step, State 12 – Wait Discharging
1	Normal Charging	Battery is fast charging T_b: 11-45°C	@100mA to 4200mV Up to 8 hrs charge time
2	Hot Charging	Battery is slow charging T_b: 45-60°C	@20mA to 4100mV Up to 40 hrs charge time
3	Battery Won't Charge	Battery has not completed charging in 8/40 hours	Charging is suspended for 5 minutes and then tried again.
4	Battery Too Hot	Not Charging T_b: > 60°C	Charging cycle resumes when battery temperature falls to 60°C or less.
5	Cold Charging	Battery is slow charging T_b: 0-10°C	@20mA to 4200mV Up to 40hrs charge time
6	Battery Too Cold	Not Charging T_b: < 0°C	Charging cycle resumes when battery temperature climbs to 0°C or greater.
7	Error No Battery	No battery was detected at power up. It will not attempt to charge until the next power cycle.	%SR55.13 = ON
8	Final Charge to 4.1V	The battery has fully charged to 4.1V in Hot Charging mode.	4.1V is maintained until Normal or Cold charging can execute.
10	Error: Voltage Too Low	The battery voltage was too low at power up. It will not attempt to charge until the next power cycle. Make sure a proper battery is installed.	%SR55.13 = ON
11	Waiting	The unit has powered up and is waiting 2 minutes before attempting to charge.	After 2 minutes, charging begins even if the battery is fully charged.
12	Wait Discharging	The battery has been charged and the system is waiting for the voltage to drop before charging again.	Charging resumes when battery voltage has dropped below 4000mV.

Battery Status in System Registers

NOTE: Registers NOT supported by the XL Prime controllers.

Battery Status	
%SR55.13	ON if battery is missing or if voltage is below 2.5V
%SR195	CPU temperature in °C
%SR196	Charge State; Refer to Table 20.1
%SR197	Charging Current mA
%SR198	Battery Voltage in mV

IMPORTANT: The battery voltage shown in the **System Menu** and in **%SR198** is ONLY valid if the battery is not in the Charging State. To check battery voltage, power cycle the controller and check the battery voltage within the first two minutes of power-up. In the first two minutes after power is applied to the unit, it will be in the 'Waiting' state, which means it is not charging, %SR196 = 11.

Safety & the Rechargeable Backup Battery

The EXL6 has an advanced battery system that uses a rechargeable lithium-ion battery. The battery powers the real time clock when power is removed. To store registers, the battery continues to power the OCS for less than a second after external power is removed. In this time the registers and other retentive data is saved to internal flash memory. This battery will need about eight (8) hours of charging to last approximately two (2) years when powered off.

NOTE: For the registers to be retentive, the battery only needs to be charged and present at power down. The battery will generally last seven (7) to ten (10) years. Environmental conditions, including extreme temperatures and humidity, can affect battery life. If the battery is older than seven (7) to ten (10) years old, it is recommended that it be replaced as preventative maintenance.

WARNING: Do not use an alkaline AA battery; only use the proper battery type listed.

WARNING: DO NOT USE IF BATTERY IS LEAKING OR HAS BEEN DAMAGED.

WARNING: LITHIUM BATTERIES MAY EXPLODE OR CATCH FIRE IF MISTREATED.

DO NOT RECHARGE, DISASSEMBLE, HEAT ABOVE 100° C (212° F) INCINERATE, OR PUNCTURE.

WARNING: EXPLOSION HAZARD – BATTERIES MUST BE ONLY BE CHANGED IN A AREA KNOWN TO BE NON-HAZARDOUS.

WARNING: Disposal of lithium batteries must be done in accordance with federal, state, and local regulations. Be sure to consult with the appropriate regulatory agencies before disposing batteries. In addition, do not recharge, disassemble, heat or incinerate lithium batteries.

WARNING: Do not make substitutions for the battery. Be sure to only use the authorized part number to replace the battery.

Steps to Replace the Rechargeable Battery

Below are the steps to replace the lithium-ion battery, part no. **BAT0019**, available from Horner APG.

1. Make sure the user program and any data stored in retentive memory is backed up.
2. Disconnect all power from the XL6 OCS unit including I/O power. Unplug I/O connections.
3. Using a small Phillips screwdriver, remove the I/O back panel, which is the smaller back panel, by turning four (4) corner screws counterclockwise.
4. Carefully lift off the I/O back panel. Be aware that a small insert may come loose from the back cover. It can be inserted when back panel is replaced.
5. After the I/O back panel is removed, carefully rock the I/O circuit board until released from the unit and lift straight up from the unit. Set carefully to the side.
6. Remove the larger back cover by turning four (4) corner screws counterclockwise. Once again, an insert may come loose from this cover.
7. Remove the Lithium battery carefully.
8. Insert new battery by aligning the positive (+) end of the battery with the positive (+) sign on the board.
9. Replace the larger back panel by carefully aligning the four (4) screws into the guideposts. If an insert came off, be sure to slide it back into the cover before replacing.
10. This unit has self-tapping screws. Once the screws are aligned, gently turn the screw counterclockwise until it "clicks". Then turn the screw clockwise until screw is seated.
11. Once the larger back panel is replaced, gently replace the I/O circuit board by aligning the edges with the guideposts. Align the XL Bus Connector, and then gently press on the I/O circuit board until it is seated. If an insert came off, be sure to slide it back into the cover before replacing.
12. After the I/O circuit board is replaced, replace the I/O back cover by aligning the screws with the posts.
13. Once the screws are aligned, turn the screw counterclockwise until it "clicks". Then turn the screw clockwise until the screw is seated.
14. Apply power and restore program and registers if necessary.
15. Allow the unit to remain powered near room temperature (10-35°C) for 6 to 8 hours. This will ensure the battery is fully charged properly for the first time.
16. Once the battery is charged, test the battery function by removing power and re-applying. Registers and clock function should be retained and there are no error messages on power up.
17. Once charged, the battery management system will maintain the battery at optimal charge depending on use and temperature.

Once charged, the battery management system will maintain the battery at optimal charge depending on use and temperature.

Prime Series Backup Battery



Prime OCS Battery

Safety	188
Replacing the Battery	189

Safety

NOTE: This does not include the XL Series, only the Prime Series.

The Prime OCS has an improved memory architecture that does not require a battery for program or register retention. The onboard lithium coin-cell battery runs the **real time clock** and is user replaceable with an expected life-time of seven (7) to ten (10) years.

Environmental conditions, including extreme temperatures and humidity, can affect battery life. If the battery older than seven (7) to ten (10) years old, it is recommended that it be replaced as preventative maintenance. NOTE: Use only the proper battery type listed.

NOTE: Use only the proper battery type listed.

- **WARNING: DO NOT USE IF BATTERY IS LEAKING OR HAS BEEN DAMAGED.**
- **WARNING: LITHIUM BATTERIES MAY EXPLODE OR CATCH FIRE IF MISTREATED.**
- **WARNING: DO NOT RECHARGE, DISASSEMBLE, HEAT ABOVE 100° C (212° F) INCINERATE, OR PUNCTURE.**
- **WARNING: EXPLOSION HAZARD – BATTERIES MUST BE ONLY BE CHANGED IN A AREA KNOWN TO BE NON-HAZARDOUS.**
- **WARNING: Disposal of lithium batteries must be done in accordance with federal, state, and local regulations. Be sure to consult with the appropriate regulatory agencies before disposing batteries. In addition, do not recharge, disassemble, heat or incinerate lithium batteries.**
- **WARNING: Do not make substitutions for the battery. Be sure to only use the authorized part number to replace the battery.**

Replacing the Battery

The Prime OCS uses a lithium coin-type battery with part no. **HE-BAT013**, with harness and connector available from Horner APG.

WARNING: Replacing the battery is a delicate procedure. If unsure about the procedure, please contact Horner Tech Support via [Horner Contact Us](#).

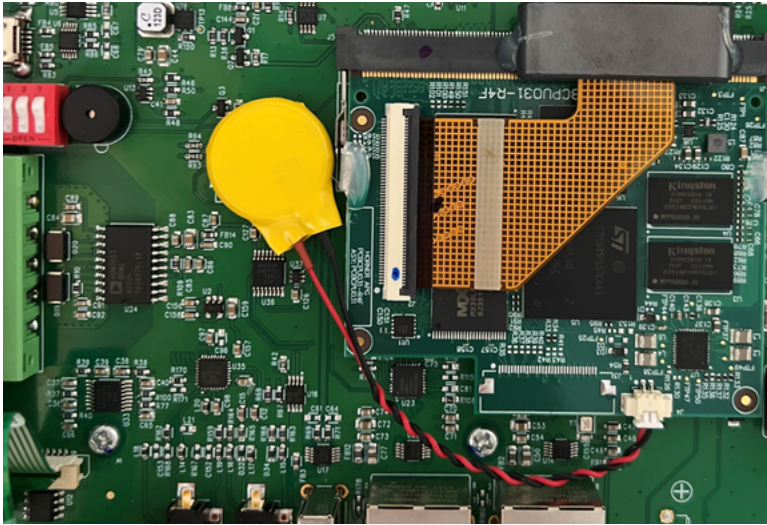

Below are the steps to replace the battery:

1. Make sure the user program and any data stored in retentive memory is backed up.
2. Disconnect all power from the Prime OCS unit including I/O power.
3. On the back of the Prime OCS model, remove the back cover by removing four screws found in the corners of the panel. **NOTE:** In some models, a board must also be removed.
4. Connect the new battery into the adjacent connector first and then carefully remove the old battery. With a small piece of tape provided, attach the new battery to the board.
5. Dispose of the old battery properly; see the above warning on disposal regulations.
6. Carefully place the back panel (and board if necessary) and replace the four screws.
7. Apply power to the unit. Check that the battery error is no longer reported. If the unit still reports the error, remove the battery immediately and contact Technical Support.

Firmware Update



Firmware Updates

Check for Current Firmware Revision	191
Firmware Update Details	192
Download Firmware	192
Firmware Update Steps	193

The EXL6/XL6 Prime OCS products contain field updatable firmware to allow new features to be added to the product. Firmware updates should only be performed when a new feature or correction is required.

WARNING: Firmware updates should only be performed when the equipment being controlled by the OCS is in a safe, non-operational state. Communication or hardware failures during the firmware update process can cause the controller to behave erratically resulting in injury or equipment damage. Make sure the functions of the equipment work properly after a firmware update before returning the device to an operational mode.

Check for Current Firmware Revision

To check the firmware revision on a controller, open **System Menu > View Status**.

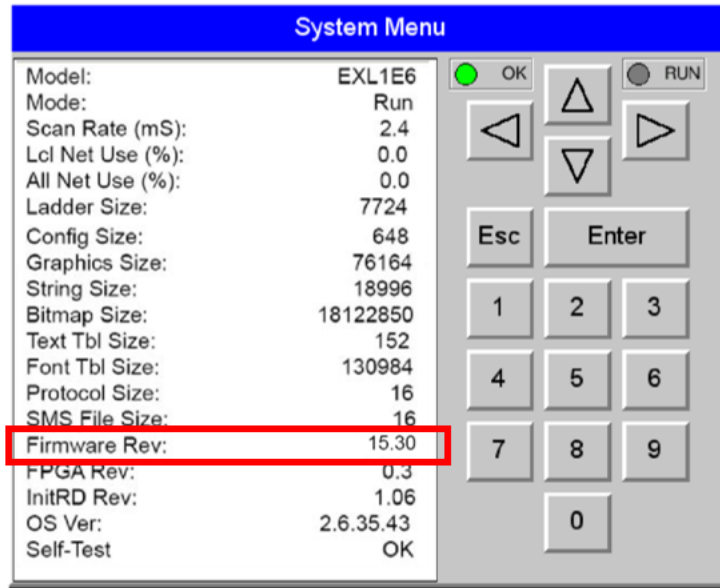

Firmware Update Details

NOTE: Updating firmware will clear the application program, screens, configurations, and register data. If required, make sure to backup program and register data before updating firmware. The controller's User Manual has instructions for doing backups.

There are two methods for updating firmware. The method used depends on the type of controller being updated.

Method A: Removable Media Method – The controller firmware is updated by a bootloader, using a microSD card or USB Flash drive (not through the Cscape Firmware Update Wizard). To update or change firmware:

1. Download desired Firmware set from the Horner APG website. (Verify CsCAN or CANopen communications.)
2. Save Firmware files to microSD card or USB, these are the removable media devices.
3. Update the firmware through the controller's Firmware Update function

NOTE: Files from the Horner website come as a .ZIP file which need to be unzipped and placed in the root of the drive for them to function properly.

Method B: RS232 Serial Connection – Serial firmware updates are done from Cscape software to the controller's primary serial port, MJ1 in most cases.

Download Firmware

In North America, visit <https://hornerautomation.com>. Then click **Support > Downloads > Controller Firmware** and download the most recent firmware set with the correct communication protocol.

-OR-

In Europe, visit <http://www.hornerautomation.eu> and click **Support > Firmware** tab and download the desired firmware (an account is required to access firmware updates, create one if necessary).

Firmware Update Steps

Update firmware in an EXL6/XL6 PRIME by completing the following steps:

1. Unzip all files from downloaded .zip file (see above) onto removable media.
2. Plug removable media into a powered-up controller.
3. Touch the upper-right-hand screen corner to slide out the control panel.
4. Press and hold the **SYSTEM** key until the **Boot Installer** screen appears. Select System upgrade option. Boot Installer screen appears. Press and hold the SYSTEM key until system recovery screen appears. Select System upgrade option. Boot Installer screen will appear.
5. Press the Install Bootloader button and then press **Yes**.
6. When Operation Completed appears, press **OK**.
7. Power-cycle the controller and wait for it to boot up.
8. Touch the upper-right-hand screen corner to slide out the control panel.
9. Press **SYSTEM** key, select **View Status** and press the Enter button.
10. If any of the version numbers are incorrect, verify the correct files were copied to the removable media device and repeat the steps above.

For more Firmware Update information refer to the [Firmware Update Manual](#), MAN1011, which can be found on the Horner website. **NOTE:** User must register and be logged into website in order to download this manual.

Troubleshooting & Tech Support



Troubleshooting

Connecting to the OCS	195
Local Controller and Local I/O	196
CsCAN Network	197
USB Interfaces	197
Basic Troubleshooting	198
Technical Support Contacts	198

Connecting to the OCS

Cscape connects to the local controller automatically when the serial connection is made. The status bar below shows an example of a successful connection. This status bar is located in the bottom right-hand corner of the Cscape window.

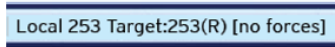

In general, the Target number should match the Local number. The exception to this is when the controller is being used as a "pass through" unit where other controllers on a CsCAN network could be accessed through the local controller. See Cscape Help File for more details.

Determine connection status by examining feedback next to Local & Target in the status bar of Cscape.

Cscape Target & Local Numbers	
Local: ###	If a number shows next to Local then communication is established to the local controller.
Local: No Port	Cscape is unable to access the COM port of the PC. This could mean that Cscape is configured for a COM port that is not present or that another program has control of the COM port. Only one Cscape window can access a port at a time. Subsequent instances of Cscape opened will indicate No Port.
Local: No Com	Cscape has accessed a PC COM port but is not communicating with the controller. This typically occurs when the controller is not physically connected.
Local: ???	Unknown communication error. Close Cscape, power cycle the controller and reopen Cscape with a blank project. Check Local.
Target: #(I,R,D)	If I (idle), R (run), or D (do I/O) shows next to Target number , then communication is established to the target controller.
Target: #(?)	Communication is not established to the target controller. Check node ID of controller and set Target to match. Make sure local connection is established.

Serial Port – MJ1 Programming

1. Controller must be powered up.
2. Ensure that the correct COM port is selected in Cscape. **Tools > Applications Settings > Communications**.
3. Ensure that a cable with proper pinout is being used between PC and controller port MJ1.
4. Check that a Loaded Protocol or ladder is not actively using MJ1. Taking the controller out of Run Mode from the System Menu on the controller will make MJ1 available to Cscape.
5. Successful communications with USB-to-serial adapters vary. If in doubt, Horner APG offers a USB to serial adapter: part number [HE-CPK](#).

USB Port - Mini B Programming

1. Controller must be powered up.
2. Ensure that the correct COM port is selected in Cscape. **Tools > Applications Settings > Communications.**
3. Be sure that the USB cable is connected between the PC and the controller. Check Windows Device Manager to ensure that the USB driver is properly installed and to verify the port number.

ETN Port Programming

1. Controller must be powered up.
2. Ensure that the correct IP address is given in the Ethernet field and correct Mode is selected, in Cscape: **Tools > Applications Settings > Communications.**
3. Ensure that an Ethernet connection has been established by pinging the controller from the Windows DOS prompt.

Local Controller and Local I/O

The System Menu provides the following status indications that are useful for troubleshooting and system maintenance. To view the System Menu, press the **System** key.

- Self-test results, diagnostics.
- RUN and OK status
- Network status and usage
- Average logic scan rate
- Application memory usage
- Loaded firmware versions
- Loaded protocols
- Removable media access

Local I/O Troubleshooting Checklist

1. Verify the controller is in RUN mode.
2. Check diagnostics to ensure controller passed self-tests. View Diags in System Menu or in Cscape, click Controller/Diagnostics.
3. Check data sheets to ensure proper wiring.
4. Ensure that hardware jumpers and software configuration for I/O match.
5. Check data sheets for voltage and current limits.
6. Take ladder out of the picture. From Cscape set controller to “Do I/O” mode. In this mode inputs can be monitored, and outputs set from a data watch window in Cscape without interference from the ladder program. Some I/O problems are only a result of a mistake in the ladder program.

WARNING: Setting outputs ON in Do I/O mode can result in injury or cause machinery to engage in an unsafe manner depending on the application and the environment.

CsCAN Network

For complete information on setting up a CsCAN network, refer to CAN Networks manual (MAN0799) by using Horner's [Documentation Search](#) page.

Network status, node ID, errors, and baud rate in the controller System Menu are all in reference to the CsCAN network. These indications can provide performance feedback on the CsCAN network and can also be used to aid in troubleshooting.

CsCAN Network Troubleshooting Checklist

1. Use the proper Belden wire type or equivalent for the network as specified in the [CAN Networks Manual](#), MAN0799.
2. The Horner OCS does not provide 24VDC to the network. An external voltage source must be used for other devices such as SmartStix I/O.
3. Check voltage at both ends of the network to ensure that voltage meets specifications of attached devices.
4. Proper termination is required. Use 121 Ω (or 120 Ω) resistors at each end of the network. The resistors should be placed across the CAN_HI and CAN_LO terminals.
5. Measure the resistance between CAN_HI and CAN_LO. If the network is properly wired and terminated, there should be around 60 Ω .
6. Check for duplicate node ID's.
7. Keep proper wires together. One twisted pair is for V+ and V- and the other twisted pair is used for CAN_HI and CAN_LO.
8. Make sure the baud rate is the same for all controllers on the network.
9. Assure shields are connected at one end of each segment—they are not continuous through the network.
10. Do not exceed the maximum length determined by the baud rate and cable type.
11. Total drop length for each drop should not exceed 6m (20'). A drop may include more than one node. The drop length adds to the overall network length.
12. Network should be wired in "straight line" fashion, not in a "star" pattern.
13. In applications requiring multiple power supplies, make sure the V- of all supplies is connected and to earth ground at one place only.
14. In some electrically noisy environments, it may be necessary to add repeaters to the network. Repeaters can be used to add additional nodes and/or distance to the network and protect the signal against noisy environments.

USB Interfaces

- Plugging and unplugging USB devices while the OCS is powered up can cause the OCS to reset. In general, branded USB memory sticks will not cause this problem, however, with the advent of USB 3.0 and larger / faster memory devices this cannot be guaranteed.
- Larger USB devices such as hard-drives etc. should only be attached and removed when the OCS is powered down.
- The resets are caused by short sharp current spikes when devices are added or removed from the OCS, these spikes can exceed the USB specification but are usually very short and mostly do not cause problems. Some devices however draw a longer larger current as they power up causing a brief dip in the OCS internal supplies leading to a reset.
- Standard SanDisk and Kingston ranges with read times less than 120MB/sec. should not cause resets. The display will flicker when a device is added or removed.

Basic Troubleshooting

Description	Action
OCS does not read media card.	The media card should be formatted with the controller.
OCS will not download project file.	Make sure the project file is saved as a .pgm file and not a .csp file. In addition, the file must be .pgm. The file's I/O configuration must match the controller configuration for it to download.

Technical Support Contacts

For manual updates and assistance, contact Technical Support at the following locations:

North America:

Tel: (317) 916-4274

Fax: (317) 639-4279

Website: <https://hornerautomation.com>

Email: techsppt@heapg.com

Europe:

Tel: (+) 353-21-4321-266

Fax: (+353)-21-4321826

Website: <https://www.hornerautomation.eu>

Email: technical.support@horner-apg.com

INDEX



A

Alarm Viewer 147
Alarms 146
Alpha-Numeric Keypad 143
Analog Inputs 84
Analog Outputs 93
AutoLoad 174
AutoRun 176

B

Backup / Restore Data 171
Basic Troubleshooting 198
Battery Charging Cycle 183
Battery Charging Status 184
Battery Life 182
Battery Status in System Registers 185
Beeper Acknowledgement 145

C

CAN Communications 121
 CAN1 Port Wiring 121
 Cscape Programming 122
 I/O Expansion 122
 Ladder-Controlled 122
 Port Description 121
CAN1 Port Wiring 121
Check for Current Firmware Revision 191
Clone Unit 44, 165
 Load Clone 167
 Make Clone 165
Communicating via MJ1 Serial Port 68
Communicating via On Board Ethernet Port 69
Configuration via Mini-B USB 119
Connecting to the OCS 195
Connectivity to the EXL6 & XL6 Prime 13
CsCAN Network 197
CsCAN Network Troubleshooting Checklist 197
Cscape Configuration 62, 71
 Establishing Communications 63
 Status Bar 62
 via MJ1 Serial Port 68
 via On Board Ethernet Port 69
Cscape Programming via CAN 122
Cscape Programming via Serial Port 119
Cscape Target & Local Numbers 195

D

Device List and Device Configuration 134
Digital / HSC Input Configuration 75
Digital / PWM Output Configuration 79

Dimensions 18
Dip Switches 118
Displaying and Entering Data 142
Download Firmware 192

E

Electrical Installation 22
 Ground Specifications 22
 How to Test for Good Ground 22
 Primary Power Port 23
Establishing Communications 63
Ethernet Communications 124
Ethernet Configuration – IP Parameters 128
Ethernet Module Configuration 125
Ethernet Module Protocol Configuration 128
Ethernet Module Protocols and Features 124
Ethernet Module Specifications 125
ETN Port Programming 196
Examples
 PWM 112
 Scaling Analog Inputs 92
 STP 113

F

Factors Affecting Panel Layout Design and Clearances 19
Fail-Safe System 169
 AutoLoad 174
 AutoRun 176
 Backup/Restore Data 171
 Clear Backup Data 172
 Settings 170
 XL & X Series 169
 XL Prime Series 169
Fail – Safe System 41
FCC Compliance 9
Features of EXL6/XL6 Prime OCS 14
Field-Programmable Gate Array (FPGA) 95
Filenames 163
Firmware Update
 Download Firmware 192
Firmware Update Details 192
Firmware Update Steps 193
Firmware Updates 191
 Check for Current Revision 191
For the XL & X Series 169
For the XL Prime Series 169
FPGA 95
Frequency 97
Function Blocks in Cscape 162

G

General I/O Configuration 73
 Analog Inputs 84
 Analog Outputs 93
 Digital Input 75
 Digital Output 79
 HSC Input 75
 PWM Output 79
 Relay Outputs 80
 Scaling Analog Inputs & Examples 92
 Solid State Digital Outputs 79
Ground Specifications 22

H

High-Speed IO 102
 4 HSC Configuration 106
 Frequency 97
 Glossary 96
 HSC 97
 HSC I/O Filtering 114
 Period Measurement 100
 Pulse Width Measurement 99
 Quadrature 101
 Register Map - 2 HSC 104
 Register Maps 104
 Register Match 102
 Status Bits 103
 Totalize 97
High Speed Counter (HSC) Functions 97
High Speed Counter Match 109
High Speed I/O (HSC / PWM) 95
High Speed I/O Glossary 96
High Speed Output Functions 108
 Normal 108
 PWM 108
 PWM - 2 Counter 111
 PWM 4- Counter 111
 PWM Examples 112
 PWM Output Waveform 109
 Stepper 110
 STP Examples 113
High Speed Output Functions Register Map 111
How to Test for Good Ground 22
HSC Functions 102
HSC Functions Register Maps 104
HSC Functions Registers Map 60
HSC I/O Filtering 114
HSC Input Configuration 75

I

I/O Register Map 59

Installation Procedure 19
Intro to the EXL6 & XL6 Prime 12

L

Ladder-Based Screen Navigation 145
Ladder-Controlled CAN Communication 122
Ladder-Controlled Serial Communication 119
LED Indicator Lights 25
Lithium Battery Safety 182
Load Clone 167
Local Controller and Local I/O 196
Local I/O Troubleshooting Checklist 196
Log Data 160

M

Make Clone 165
Mechanical Installation 16
 Dimensions 18
 Installation 19
 Mounting 16
 Panel Design 19
microSD Cards 159
microSD File System 160
Modbus Addressing Table 180
Modbus Communications 178
Modbus Master Overview 179
Modbus Slave Overview 178
Mounting Clip 17
Mounting Orientation 17
Mounting Requirements 16

N

Navigation and Editing 26
Network Configuration 132
Network Protocols 133
Normal 108

O

Opening Video Object in Cscope 153

P

Period Measurement 100
Port Descriptions 117
Primary Power Port 23
Prime OCS Battery 188
 Replacing the Battery 189
 Safety 188
Protocol Configuration 130
 Data Mapping 138
 Device Configuration 135

Set Serial Ports 35
Set Time/Date 36
System Menu 27
Touch Screen Calibration 48
View Battery Status 31
View Diags 30
View I/O Slots 32
View Protocols 33
View Status 29
WebMI License Details 47

View Protocols 33
View Status 29
Visual Overview 12

W

Web Cameras 157
WebMI License Details 47

T

Technical Support Contacts 198
Totalize 97
Touch (Slip) Sensitivity 146
Touch Screen Pressure 150
troubleshooting
 Connecting to the OCS 195
Troubleshooting 195
 Basic Troubleshooting 198
 CsCAN Checklist 197
 CsCAN Network 197
 Cscape Target & Local Numbers 195
 ETN Port Programming 196
 Local Controller & Local I/O 196
 Local I/O Checklist 196
 Serial Port - MJ1 Programming 195
 USB Interfaces 197
 USB Port - Mini B Programming 196

U

USB Interfaces 197
USB Port - Mini B Programming 196
User Interface 141
Using CAN for I/O Expansion (Network I/O) 122
Using the Removable Media Manager 160

V

Video Object 152
 Configuration 155
 Cscape 153
 Performance 157
 Specifications 152
 Web Cameras 157
Video Object Overview 152
Video Object Performance 157
Video Properties Configuration 155
View and Capture Screens 161
View Battery 31
View Diags 30
View I/O Slots 32

Change Log

Change Log			
Date	Rev #	Description of Revision	Location in Doc
3/6/2020	R9	1. Added steps to download files to Cscape. 2. Cscape Install Step 3. Firmware Install Step 4. Added new information from New Cscape Helpfile. 5. Rearranged Rev1. 6. Added updated Cscape screenshots.	1. Files Needed 2. Cscape Install 3. Firmware Install 4. Through out 5. Throughout 6. Throughout
3/12/2020	R10	Reorder Chapters (Mantis 3029)	Throughout
4/24/2020	R10-02	Changed Table 2 with updated RTD/TC formula for Model 6. (Rev 10-01 was named per a website saving issue. No change in User Manual.)	Analog In (Cscape Config) Table 7.2
8/9/2021	R11	#4845 – Updated WebMI register #4802 – WebMI – Max # of connections Added latest Firmware Update steps #6482 – Updated Install Procedure #6319 – USB Interfaces #6442 – Battery Charging Cycle	System Register Table Ethernet Overview Firmware Update Installation Procedure USB Interfaces Battery Status in SR
11/10/2021	R12	#6985 – Added XL6 Prime Added Backup Battery for XL6 Prime #6429 – Updated Register Map Table	Throughout XL6 Prime Battery 6.3 Register Map for EXL6/XL6 PRIME OCS I/O
12-12-22	20	#8470 - Convert to Madcap Flare Output #8982 - Updated Prime Battery info	Throughout Prime Battery Info
1-30-23	21	#9514 - Adding missing Resource tables	System Register Chapter
3-22-23	22	Reformatted TOC, Index, Tables, etc	Throughout