

User Manual for XLE / XLEe XLT / XLTe



MAN0878-22_XLE-T_UM

LIMITED WARRANTY AND LIMITATION OF LIABILITY

Horner APG, LLC. ("HE-APG") warrants to the original purchaser that the XLE/XLT OCS module manufactured by HE-APG is free from defects in material and workmanship under normal use and service. The obligation of HE-APG under this warranty shall be limited to the repair or exchange of any part or parts which may prove defective under normal use and service within two (2) years from the date of manufacture or eighteen (18) months from the date of installation by the original purchaser whichever occurs first, such defect to be disclosed to the satisfaction of HE-APG after examination by HE-APG of the allegedly defective part or parts. THIS WARRANTY IS EXPRESSLY IN LIEU OF ALL OTHER WARRANTIES EXPRESSED OR IMPLIED INCLUDING THE WARRANTIES OF MERCHANTABILITY AND FITNESS FOR USE AND OF ALL OTHER OBLIGATIONS OR LIABILITIES AND HE-APG NEITHER ASSUMES, NOR AUTHORIZES ANY OTHER PERSON TO ASSUME FOR HE-APG, ANY OTHER LIABILITY IN CONNECTION WITH THE SALE OF THIS XLE/XLT OCS MODULE. THIS WARRANTY SHALL NOT APPLY TO THIS XLE/XLT OCS module OR ANY PART THEREOF WHICH HAS BEEN SUBJECT TO ACCIDENT, NEGLIGENCE, ALTERATION, ABUSE, OR MISUSE. HE-APG MAKES NO WARRANTY WHATSOEVER IN RESPECT TO ACCESSORIES OR PARTS NOT SUPPLIED BY HE-APG. THE TERM "ORIGINAL PURCHASER", AS USED IN THIS WARRANTY, SHALL BE DEEMED TO MEAN THAT PERSON FOR WHOM THE XLE/XLT OCS MODULE IS ORIGINALLY INSTALLED. THIS WARRANTY SHALL APPLY ONLY WITHIN THE BOUNDARIES OF THE CONTINENTAL UNITED STATES.

In no event, whether as a result of breach of contract, warranty, tort (including negligence) or otherwise, shall HE-APG or its suppliers be liable of any special, consequential, incidental or penal damages including, but not limited to, loss of profit or revenues, loss of use of the products or any associated equipment, damage to associated equipment, cost of capital, cost of substitute products, facilities, services or replacement power, down time costs, or claims of original purchaser's customers for such damages.

To obtain warranty service, return the product to your distributor with a description of the problem, proof of purchase, post paid, insured and in a suitable package.

ABOUT PROGRAMMING EXAMPLES

Any example programs and program segments in this manual or provided on accompanying diskettes are included solely for illustrative purposes. Due to the many variables and requirements associated with any particular installation, Horner APG cannot assume responsibility or liability for actual use based on the examples and diagrams. It is the sole responsibility of the system designer utilizing the XLE/XLT OCS module to appropriately design the end system, to appropriately integrate the XLE/XLT OCS module and to make safety provisions for the end equipment as is usual and customary in industrial applications as defined in any codes or standards which apply.

NOTE: The programming examples shown in this manual are for illustrative purposes only. Proper machine operation is the sole responsibility of the system integrator.

Preface

This manual explains how to use the XLE/XLT OCS Modules.

Copyright (C) 2008 Horner APG, LLC., 59 South State Avenue, Indianapolis, Indiana 46201. All rights reserved. No part of this publication may be reproduced, transmitted, transcribed, stored in a retrieval system, or translated into any language or computer language, in any form by any means, electronic, mechanical, magnetic, optical, chemical, manual or otherwise, without the prior agreement and written permission of Horner APG, Inc.

All software described in this document or media is also copyrighted material subject to the terms and conditions of the Horner Software License Agreement.

Information in this document is subject to change without notice and does not represent a commitment on the part of Horner APG.

Cscape, SmartStack, SmartStix, SmartRail, and CsCAN are trademarks of Horner APG. Ethernet is a trademark of Xerox Corporation®.

microSD® and CompactFlash are registered trademarks of SanDisk Corporation®.

Published with Madcap Flare®.

North America

Tel: (+) (317) 916-4274

Fax: (+) (317) 639-4279

Website: <https://hornerautomation.com>

Email: techspt@heapg.com

Europe

Tel: (+) 353-21-4321-266

Fax: (+) 353-21-4321-826

Website: <https://www.hornerautomation.eu>

Email: technical.support@horner-apg.com

Table of Contents

Safety and Compliance	8
Warnings	8
FCC Compliance	8
Safety Precautions	9
Introduction to the XLE/XLT	11
Visual Overview	11
Where to find more information for the XLE/XLT	12
Connectivity to the XLE/XLT	12
Features of the XLE/XLT	13
Mechanical Installation	15
Mounting Procedures	15
Mounting Orientation	16
Panel Cutout	17
Installation	18
Factors Affecting Panel Layout Design and Clearances	18
Electrical Installation	21
Ground Specifications	21
How to Test for Good Ground	21
Primary Power Port	22
System Settings	24
System Menu	24
Set Network and Contrast	28
View Status, Diags, I/O Slots and Protocols	29
Set Keys, Serial Ports, Ethernet, Time/Date and Beeper	33
Removable Media	35
Fail-Safe System	39
Clone Unit	41
Touch Screen Calibration for XLT/XLT _e	43
System Register Tables	45
Register Definitions	45
%S Registers	46
%SR Registers	47
I/O Register Map for XLE/XLT	54
XLE/XLT Resource Limits	55
Cscape Configuration	57
XLE & XLT Background	57
Cscape Status Bar	58
Establishing Communications	59
Communicating via MJ1 Serial Port	63
Communicating via On Board Ethernet Port	64
Cscape Configuration	65
General I/O Configuration	67
Built-in Digital and Analog I/O Overview	67
Removing the Back Cover	68
Digital / HSC Input Configuration	69
Digital / PWM Output Configuration	73
Solid State Digital Outputs	73
Relay Outputs	74
Digital Output Configuration	75

Analog Inputs	78
Scaling Analog Inputs & Examples	86
Analog Outputs	87
High Speed I/O	89
High Speed Counter (HSC) Functions	89
Frequency	89
Totalize	90
Pulse	91
Period Measurement	91
Quadrature	92
HSC Register Map for XLE & XLT	94
Pulse Width Modulation (PWM) Functions	95
HSC Output	99
Stepper Function	101
Serial Communications	105
Port Descriptions	105
Serial Port Wiring	106
Dip Switches	107
RS-485 Termination	108
RS-485 Biasing	108
Cscope Programming via Serial Port	108
Ladder-Controlled Serial Communication	108
CAN Communications	110
CAN Connector	110
CAN Termination	111
Cscope Programming via CAN	111
Ethernet Communication	113
Ethernet Module Protocols and Features	113
Ethernet System Requirements	113
Ethernet Module Configuration	114
Ethernet Configuration - IP Parameters	117
Ethernet Module Protocol Configuration	117
Protocol Configuration	119
Overview	119
Protocol Device Driver Selection	120
Network Configuration	121
Device List and Device Configuration	123
Scan List	125
User Interface	130
Screen Navigation	130
Using Editable Screen Objects	131
Ladder Based Screen Navigation	131
Alarms	132
Screen Saver	134
Screen Brightness	134
Removable Media	136
microSD Cards	136
Using the Removable Media Manager	138
Log Data	138
Load and Save Applications	138
View and Capture Screens	139
Removable Media (RM) Function Blocks in Cscope	139
Filenames and Function Blocks	141

System Registers used with RM	141
Clone Unit	143
Clone	143
Load Clone	146
Fail-Safe System	149
Fail-Safe Features	149
Settings	150
Backup / Restore Data	150
Flow Chart for Automatic Restore	152
AutoLoad	153
AutoRun	155
Modbus Communications	157
Modbus Slave	157
Modbus Master	158
Modbus Addressing Tables for XLE/XLT Units	159
Backup Battery	162
Precautions & Safety	162
Steps for Battery Replacement	163
Firmware Update	165
Firmware Update Details	165
Download Firmware	166
Update Firmware Steps	166
Firmware Update via microSD card	167
Manual Firmware Update via %SR's	168
Auto firmware update via %SR's	168
Troubleshooting	170
Connecting to the XLE/XLT	170
Local Controller and Local I/O	171
CsCAN Network	172
Removable Media Troubleshooting	173
Technical Support Contacts	173
INDEX	174
Change Log	178

Safety and Compliance



Safety and Compliance

Warnings

When found on the product, the following symbols specify:



Warning: Consult user documentation.



Warning: Electrical Shock Hazard.

WARNING: EXPLOSION HAZARD – Substitution of components may impair suitability for Class I, Division 2.

WARNING: EXPLOSION HAZARD – Do not disconnect equipment unless power has been switched off or the area is known to be non-hazardous.

1. To avoid the risk of electric shock or burns, always connect the safety (or earth) ground before making any other connections.
2. To reduce the risk of fire, electrical shock, or physical injury it is strongly recommended to fuse the voltage measurement inputs. Be sure to locate fuses as close to the source as possible.
3. Replace fuse with the same type and rating to provide protection against risk of fire and shock hazards.
4. In the event of repeated failure, do not replace the fuse again as a repeated failure indicates a defective condition that will not clear by replacing the fuse.
5. Only qualified electrical personnel familiar with the construction and operation of this equipment and the hazards involved should install, adjust, operate, or service this equipment. Read and understand this manual and other applicable manuals in their entirety before proceeding. Failure to observe this precaution could result in severe bodily injury or loss of life.

NOTE: All applicable codes and standards need to be followed in the installation of this product.

NOTE: For I/O wiring (discrete), use the following wire type or equivalent: Belden 9918, 18 AWG or larger.

NOTE: See the "Electrical Installation" on page 21 for more details.

FCC Compliance

This device complies with Part 15 of the FCC Rules. Operation is subject to the following two conditions:

1. This device may not cause harmful interference.
2. This device must accept any interference received, including interference that may cause undesired operation.

Safety Precautions

Adhere to the following safety precautions whenever any type of connection is made to the module:

All applicable codes and standards need to be followed in the installation of this product. Adhere

to the following safety precautions whenever any type of connection is made to the module:

1. Connect the safety (earth) ground on the power connector first before making any other connections.
2. When connecting to the electric circuits or pulse-initiating equipment, open their related breakers.
3. Do NOT make connection to live power lines.
4. Make connections to the module first; then connect to the circuit to be monitored.
5. Route power wires in a safe manner in accordance with good practice and local codes.
6. Wear proper personal protective equipment including safety glasses and insulated gloves when making connections to power circuits.
7. Ensure hands, shoes, and floor are dry before making any connection to a power line.
8. Make sure the unit is turned OFF before making connection to terminals.
9. Make sure all circuits are de-energized before making connections.
10. Before each use, inspect all cables for breaks or cracks in the insulation. Replace immediately if defective.
11. Use copper conductors in Field Wiring only, 60/75°C.
12. Use caution when connecting controllers to PCs via serial or USB. PCs, especially laptops may use “floating power supplies” that are ungrounded. This could cause a damaging voltage potential between the laptop and controller. Ensure the controller and laptop are grounded for maximum protection. Consider using a USB isolator due to voltage potential differences as a preventative measure.

Introduction to the XLE and XLT



Introduction to the XLE/XLT

Visual Overview	11
Where to find more information for the XLE/XLT	12
Connectivity to the XLE/XLT	12
Features of the XLE/XLT	13

Visual Overview



1. Function Keys
2. Softkeys
3. Navigation Keys
4. Touchscreen
5. Wide Range DC Power
6. CAN Port
7. Mounting Clip Locations
8. RS232/RS485 Serial Ports (2)
9. USB Mini-B Port
10. Ethernet LAN Port (optional)
11. Optional Built-In I/O
12. High Capacity microSD Slot
13. Configuration Switches
14. DIN Rail Clip



Where to find more information for the XLE/XLT

Datasheets - The datasheets are the first documents to refer to for key information related to specific XLE/XLT models. (A basic datasheet is provided in the box with the unit.) Find the documents via the [Documentation Search](#) page on the Horner website.

Datasheet Manual Numbers	
Model 0	MAN1112
Model 2	MAN1113
Model 3	MAN1114
Model 4	MAN1115
Model 5	MAN1116
Model 6	MAN1117

Connectivity to the XLE/XLT

Connectivity to the XLE/XLT				
CAN	Serial	I/O	USB	Ethernet Options
Other OCS Devices	Other OCS Devices	Sensors	USB Slave	Other OCS Devices
SmartStix I/O	Drivers	Indicators	Programming / Monitoring Port	Drives
SmartBlock I/O	PLCs	Alarms		PLCs
SmartRail I/O	Bar Code Readers	Encoders		SCADA
	Printers	Pumps		OPC Server
	SCADA	Relays		Portal
	OPC Servers	Solenoids		I/O Devices
	Serial I/O		SmartRail Devices	

Features of the XLE/XLT

The XLE/XLT is an all-in-one industrial control device. It combines control, user interface, I/O and networking into a single, integrated package. Unique features of the XLE/XLT include:

- Bright, graphical LCD display (in XLE) (with touch sensing in XLT)
- Display of complex graphical objects including trends, gauges, meters and animations
- Advanced control capabilities including floating point, multiple auto-tuning PID loops and string handling capabilities
- Removable media for up to two terabytes of storage of programs, data logging or screen captures
- CsCAN networking port (optional) for communication with remote I/O, other controllers or PCs.
- Ethernet version (XLEe/XLTe) with native Ethernet for communication with other controllers, drives, PCs, etc.
- Configurable serial protocols for communication to drives, PLCs, or other serial peripherals.
- USB 2.0 full speed port for programming and monitoring.
- Full featured, built-in I/O including high resolution analog, thermocouple, RTD, high-speed counters, PWM outputs, and relays (depending upon the XLE/XLT model used).
- Cscape programming software that allows all aspects of the XLE/XLT, XLEe/XLTe to be programmed and configured from one integrated application.
- Optional communication add-on modules that allow additional capabilities such as Ethernet (pre-Rev TA only) or modems.
- Fail – Safe System which allows an application to continue running in the event of “Soft” failures such as (Battery power loss or Battery Backed register RAM / Application Flash corruption)
- Clone Unit allows the user to “clone” the OCS of the exact same model. This feature “clones” application program and unit settings stored in Battery backed RAM of an OCS. It can then be used to clone a different OCS (exact same model).

Mechanical Installation



Mechanical Installation

Mounting Procedures	15
Mounting Orientation	16
Panel Cutout	17
Installation	18
Factors Affecting Panel Layout Design and Clearances	18

NOTE: The datasheet is the first document to refer to for model-specific information related to XLE/XLT models such as pin-outs, jumper settings, and other key installation information. See the [Documentation Search](#) for data-sheets.

Mounting Procedures

The mechanical installation greatly affects the operation, safety, and appearance of the system. Information is provided to mechanically install the unit such as cut-out sizes, mounting procedures, and other recommendations for the proper mechanical installation of the unit. XLE/XLT products can be mounted through a panel or on DIN rail.

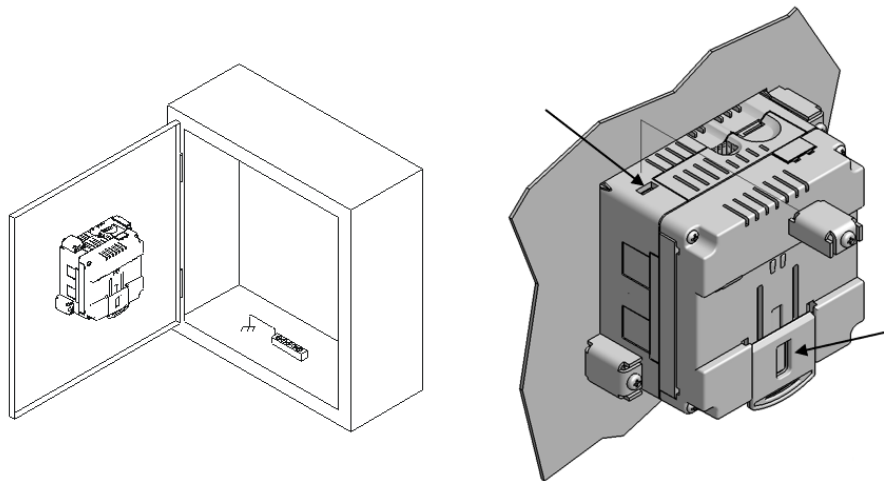

Once the panel design has been completed using the criteria and suggestions in the following sections, use the following steps to panel mount the XLE/XLT.

1. Remove all connectors from the XLE/XLT unit.
2. Press the DIN rail clip up to make passing the unit through the cutout easier.
3. Make sure the gasket is installed on the XLE/XLT and is free from dust and debris. Check that the corners of the gasket are secure.
4. Pass the unit through the panel.
5. Insert the each of the four (4) mounting clips into the slots in the XLE/XLT case. One clip should be installed on each corner. Lightly tighten each screw so the clip is held in place.
6. Tighten the screws on the clips such that the gasket is compressed against the panel. Recommended torque is 7-10 in-lbs [0.8-1.13 Nm]).

Mounting Procedures (Installed on DIN Rail)

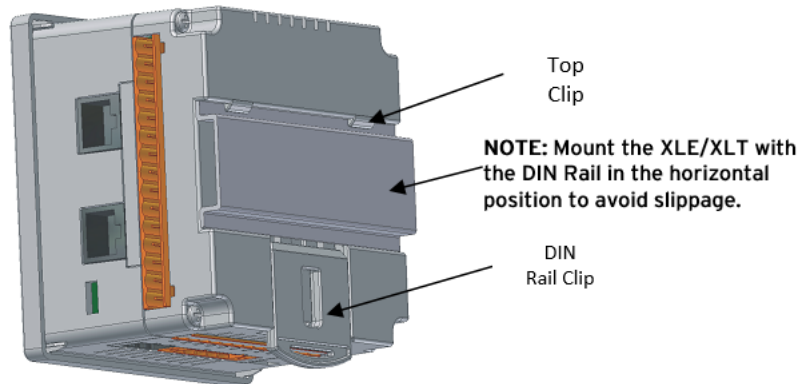

The XLE/XLT is designed to clip onto standard 35mm DIN rail. If your installation requires liquid or dust protection, make sure the XLE/XLT is placed in an appropriate sealed panel when mounting on DIN rail. Use the following steps to mount the XLE/XLT on DIN rail.

1. Move the DIN rail clip to the lower position.
2. Clip the "Top Clips" on the top of the DIN rail.
3. Press the unit into place and press the DIN rail clip up. A small flat-head screwdriver can be used in the slot of the DIN rail clip if clearance is an issue.

NOTE: The DIN rail connection does not provide an earth ground. Refer to the "Electrical Installation" on page 21 for proper grounding information.

Mounting Orientation

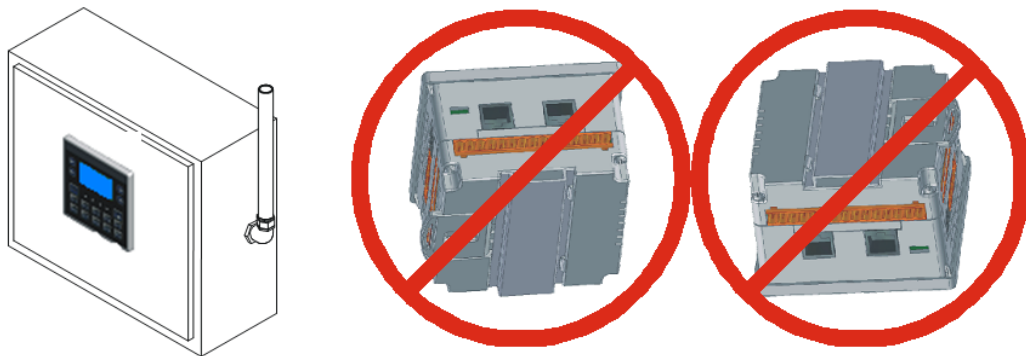

NOTE: For panel or DIN rail mounting – The orientation shown above provides optimum legibility of the screen and ease of use of the keypad.

CAUTION: For DIN rail mounting – To prevent the unit from slipping off the DIN rail, do NOT install the unit on its side as shown. Be sure the DIN rail is in the horizontal position.

Panel Cutout

For installations requiring NEMA4X liquid and dust protection the panel cutout should be cut with a tolerance of +/- 1 mm. The XLE/XLT is designed to fit 1/4 DIN panel openings. There are a number of punches and enclosures designed to accommodate opening of this size.

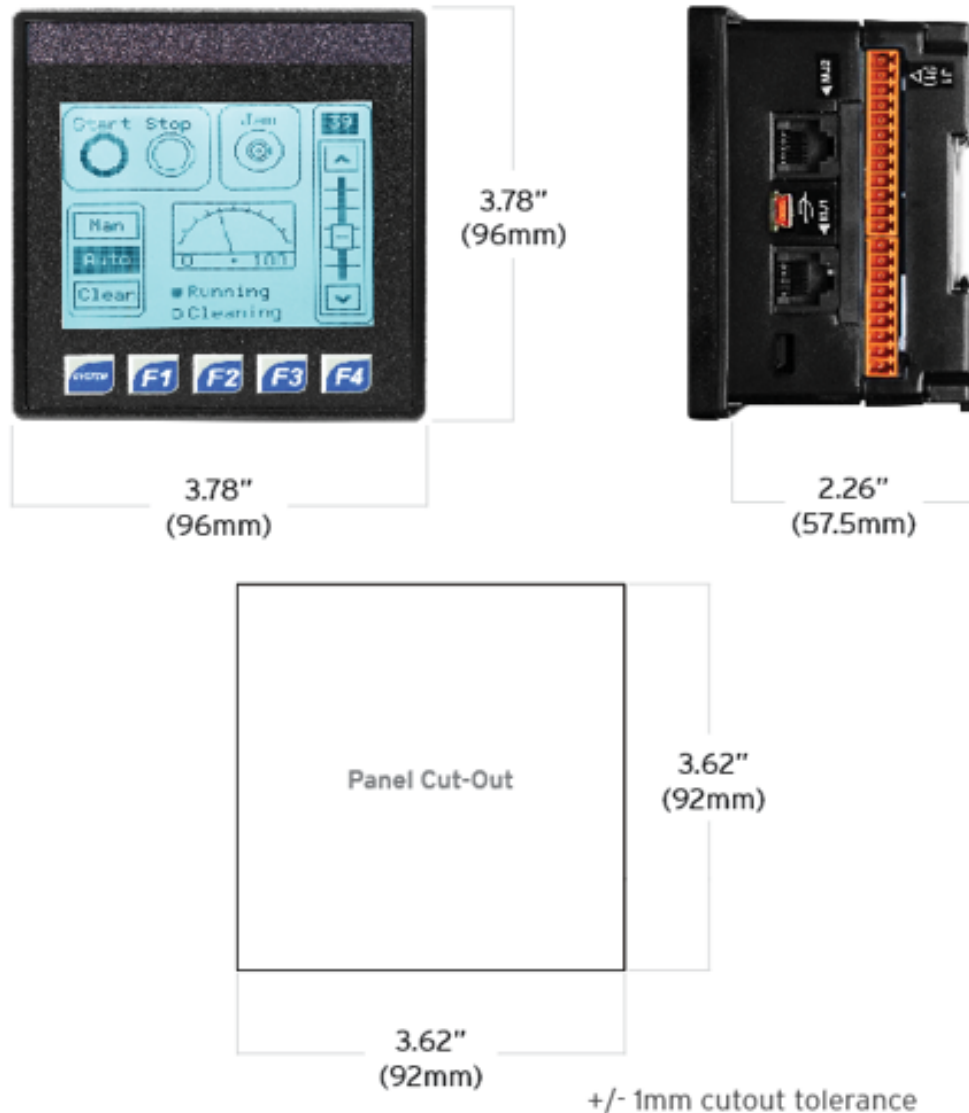

NOTE: When the communication add-on modules are installed such communication and I/O, the depth of the product increases from 2.264" (57.5mm) to 2.68" (68mm).

NOTE: The keypad overlay appearance may differ.

Installation

- The XLE/XLT utilizes a clip installation method to ensure a robust and watertight seal to the enclosure. Please follow the steps below for the proper installation and operation of the unit.
 - This equipment is suitable for Class I, Division 2, Groups A, B, C and D or non-hazardous locations only.
 - Digital outputs shall be supplied from the same source as the
 - operator control station.
 - Jumpers on connector JP1 shall not be removed or replaced while the circuit is live unless the area is known to be free of ignitable concentrations of flammable gases or vapors.
1. Carefully locate an appropriate place to mount the XLE/XLT. Be sure to leave enough room at the top of the unit for insertion and removal of the microSD™ card.
 2. Carefully cut the host panel per the diagram, creating a 92mm x 92mm +/-0.1mm opening into which the XLE/XLT may be installed. If the opening is too large, water may leak into the enclosure, potentially damaging the unit. If the opening is too small, the OCS may not fit through the hole without damage.
 3. Remove any burrs and or sharp edges and ensure the panel is not warped in the cutting process.
 4. Remove all Removable Terminals from the XLE/XLT. Insert the XLE/XLT through the panel cutout (from the front). The gasket must be between the host panel and the XLE/XLT.
 5. Install and tighten the four mounting clips (provided in the box) until the gasket forms a tight seal (NOTE: Max torque 0.8 to 1.13 Nm, 7-10 in-lbs).
 6. Reinstall the XLE/XLT I/O Removable Terminal Blocks. Connect communications cables to the serial port, USB ports, Ethernet.

Factors Affecting Panel Layout Design and Clearances

WARNING: It is important to follow the requirements of the panel manufacture and to follow all applicable electrical codes and standards.

The designer of a panel layout must assess the requirements of a particular system and to consider the following design factors.

Clearance / Adequate Space

Install devices to allow sufficient clearance to open and close the panel door.

Minimum Clearance Requirements for Panel Box and Door	
Minimum Distance between base of device and sides of cabinet	2" (50.80mm)
Minimum Distance between base of device and wiring ducts	1.5" (38.10mm)
If more than one device installed in panel box (or on door): Minimum Distance between bases of each device	4" (101.60mm) between bases of each device
When door is closed: Minimum distance between device and closed door (Be sure to allow enough depth for the OCS.)	2" (50.80mm)

Grounding

WARNING: Be sure meet the ground requirements of the panel manufacturer and also meet applicable electrical codes and standards.

- **Panel Box:** The panel box must be properly connected to earth ground to provide a good common ground reference.
- **Panel Door:** Tie a low impedance ground strap between the panel box and the panel door to ensure that they have the same ground reference.

Temperature / Ventilation

Ensure that the panel layout design allows for adequate ventilation and maintains the specified ambient temperature range. Consider the impact on the design of the panel layout if operating at the extreme ends of the ambient temperature range. For example, if it is determined that a cooling device is required, allow adequate space and clearances for the device in the panel box or on the panel door.

Noise

Consider the impact on the panel layout design and clearance requirements if noise suppression devices are needed. Be sure to maintain an adequate distance between the XLE/XLT and noisy devices such as relays, motor starters, etc.

Shock and Vibration

The XLE/XLT has been designed to operate in typical industrial environments that may inflict some shock and vibration on the unit. For applications that may inflict excessive shock and vibration please use proper dampening techniques or relocate the XLE/XLT to a location that minimizes shock and/or vibration.

Panel Layout Design and Clearance Checklist

The following list provides highlights of panel layout design factors:

- Meets the electrical code and applicable standards for proper grounding, etc.?
- Meets the panel manufacturer's requirements for grounding, etc.?
- Is the panel box properly connected to earth ground? Is the panel door properly grounded? Has the appropriate procedure been followed to properly ground the devices in the panel box and on the panel door?
- Are minimum clearance requirements met? Can the panel door be easily opened and closed? Is there adequate space between device bases as well as the sides of the panel and wiring ducts?
- Is the panel box deep enough to accommodate the XLE/XLT?
- Is there adequate ventilation? Is the ambient temperature range maintained? Are cooling or heating devices required?
- Are noise suppression devices or isolation transformers required? Is there adequate distance between the base of the XLE/XLT and noisy devices such as relays or motor starters? Ensure that power and signal wires are not routed in the same conduit.
- Are there other requirements that impact the particular system, which need to be considered?

Electrical Installation



Electrical Installation

Ground Specifications	21
How to Test for Good Ground	21
Primary Power Port	22

NOTE: The datasheet is the first document to refer to for model-specific information. Refer to the [Documentation Search](#) on the Horner website.

Ground Specifications

Ideally, a ground resistance measurement from equipment to earth ground is 0Ω. In reality it typically is higher. The US National Electrical Code (NEC) states the resistance to ground shall not exceed 25Ω. Horner Automation recommends less than 15Ω resistance from the equipment to ground. Resistance greater than 25Ω can cause undesirable or harmful interference to the device.

Grounding Definition - The term Ground is defined as a conductive connection between a circuit or piece of equipment and the earth. Grounds are fundamentally used to protect an application from harmful interference causing either physical damage such as by lightning or voltage transients or from circuit disruption often caused by radio frequency interference (RFI).

How to Test for Good Ground

In order to test ground resistance, a Ground Resistance Tester must be used. A typical Ground Resistance Meter Kit contains a meter, two or three wire leads, and two ground rods. Instructions are supplied for either a two-point or a three-point ground test. The figure shows a two-point ground connection test.

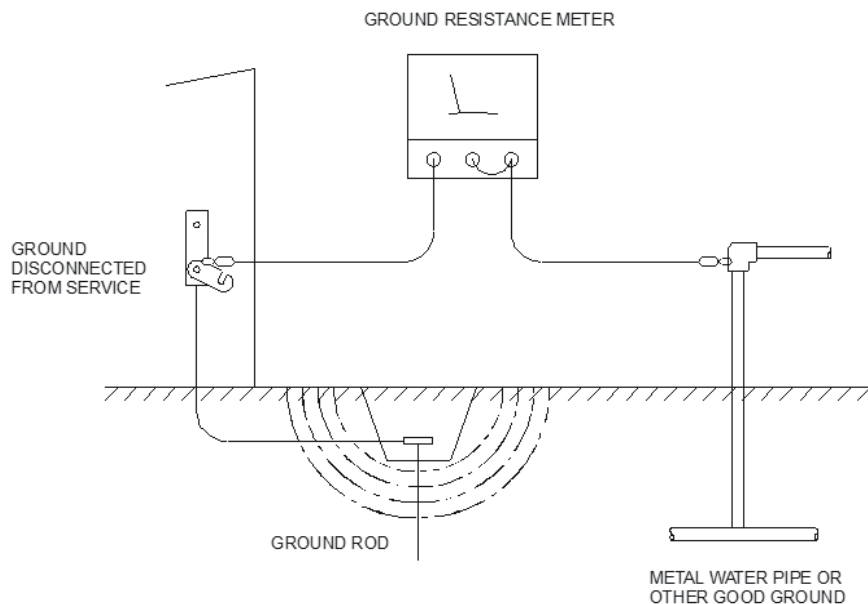

Primary Power Port

NOTE: The Primary Power Range is 10VDC to 30VDC.

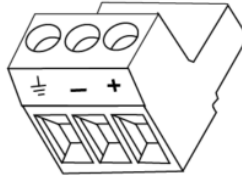

Primary Power Port Pins		
PIN	Signal	Description
1	Ground	Frame Ground
2	DC-	Input Power Supply Ground
3	DC+	Input Power Supply Voltage

DC Input / Frame

- Solid/Stranded Wire: 12-24 awg (2.5-0.2mm)
- Strip length: 0.28" (7mm)
- Torque, Terminal Hold-Down Screws: 4.5 – 7 in-lbs (0.50 – 0.78 N-m)
- DC- is internally connected to I/O V-, but is isolated from CAN V-. A Class 2 power supply must be used.

Power Up

1. **OPTION:** Attach ferrite core with a minimum of two turns of the DC+ and DC- signals from the DC supply that is powering the controllers.



2. Connect to earth ground.
3. Apply recommended power.

System Settings and Adjustments



System Settings

System Menu	24
Set Network and Contrast	28
View Status, Diags, I/O Slots and Protocols	29
Set Keys, Serial Ports, Ethernet, Time/Date and Beeper	33
Removable Media	35
Fail-Safe System	39
Clone Unit	41
Touch Screen Calibration for XLT/XLTe	43

System Menu

The XLE/XLT controller has a built-in System Menu, which lets the user view System Settings and make adjustments. To start the System Menu, press the ↑ and ↓ keys at the same time (or set %SR3 to 1), which will display the Main Menu. Then use the ↑ and ↓ keys to select a Main Menu item and press Enter to display the item's Sub-Menu.

XLE Only: The XLE display shows up to six (6) lines of text at a time. For System Menu screens that contain more than 6 lines of text, use the ↑ and ↓ keys to scroll the display.

XLT Only: The XLT display shows up to 12 lines of text at a time. For System Menu screens that contain more than 12 lines of text, scroll the display. RUN/OK LED lights indicate the following:

RUN/OK LED Lights	
RUN	<ul style="list-style-type: none"> ▪ OFF indicates OCS is in IDLE/STOP mode. ▪ Flashing indicates DO / IO mode or RUN with no ladder program. ▪ ON indicates ladder code running.
OK	<ul style="list-style-type: none"> ▪ OFF indicates one or more self-tests failed. ▪ ON indicates all self-tests passed. ▪ Flashing at 1 Hz indicates forcing is active.

System Menu – Navigation and Editing

As mentioned above, the System Menu is started by pressing the ↑ and ↓ keys at the same time for the XLE, or the System key on the XLT. Then, either press ESC to exit the System Menu, or use the ↑ and ↓ keys to select an item and press Enter to display the item's Sub-Menu.

A Sub-Menu generally shows a list of System Settings and their values. After opening a Sub-Menu, if any of its System Settings are editable, the first System Setting that can be edited is highlighted. If desired, the ↑ and ↓ keys can be used to select a different System Setting to be edited.

At this point, either press ESC to exit the Sub-Menu (returning to the Main Menu) or press Enter to edit the highlighted System Setting. If Enter is pressed, the System Setting's value will be highlighted, indicating that it is ready to be modified.

When modifying a System Setting's value, use either the arrow keys (← → ↑ ↓) or the numeric keys, or the appropriate touch screen icons to select a new value.

The arrow keys are used to edit System Settings that have just a few possible values. Each time the arrow key is pressed, a new possible value is displayed. When the desired value appears, press the Enter key to save it; otherwise press the ESC key to cancel the edit.

The numeric keys are normally used to enter numeric System Settings. In addition, to edit a single numeric digit, use the ← or → key to select the digit and then either press a numeric key or use ↑ or ↓ to modify the digit. In any case, after entering the new desired value, press the Enter key to save it; otherwise press the ESC key to cancel the edit.

XLE/XLEe System Menu Map

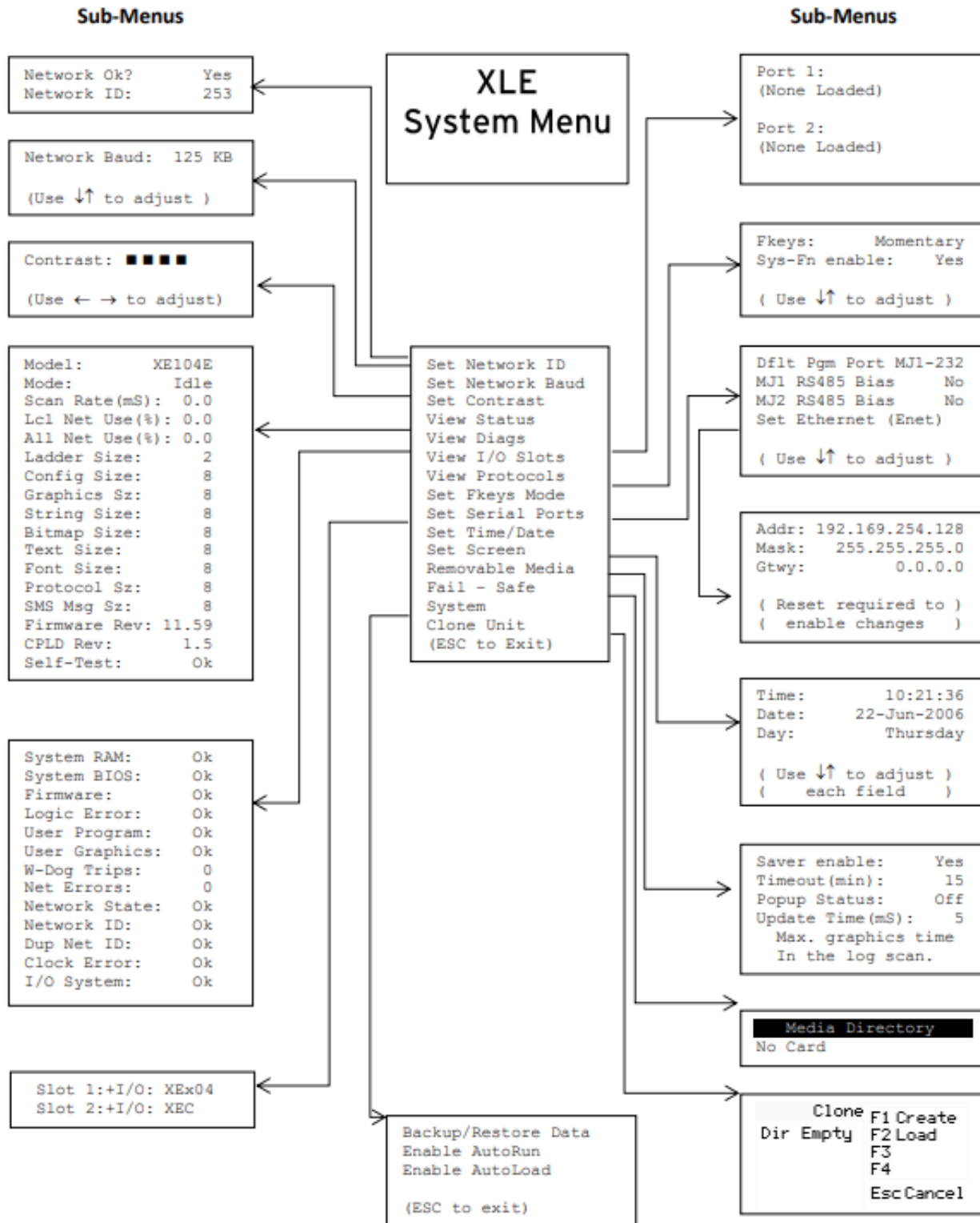

XLTe System Menu

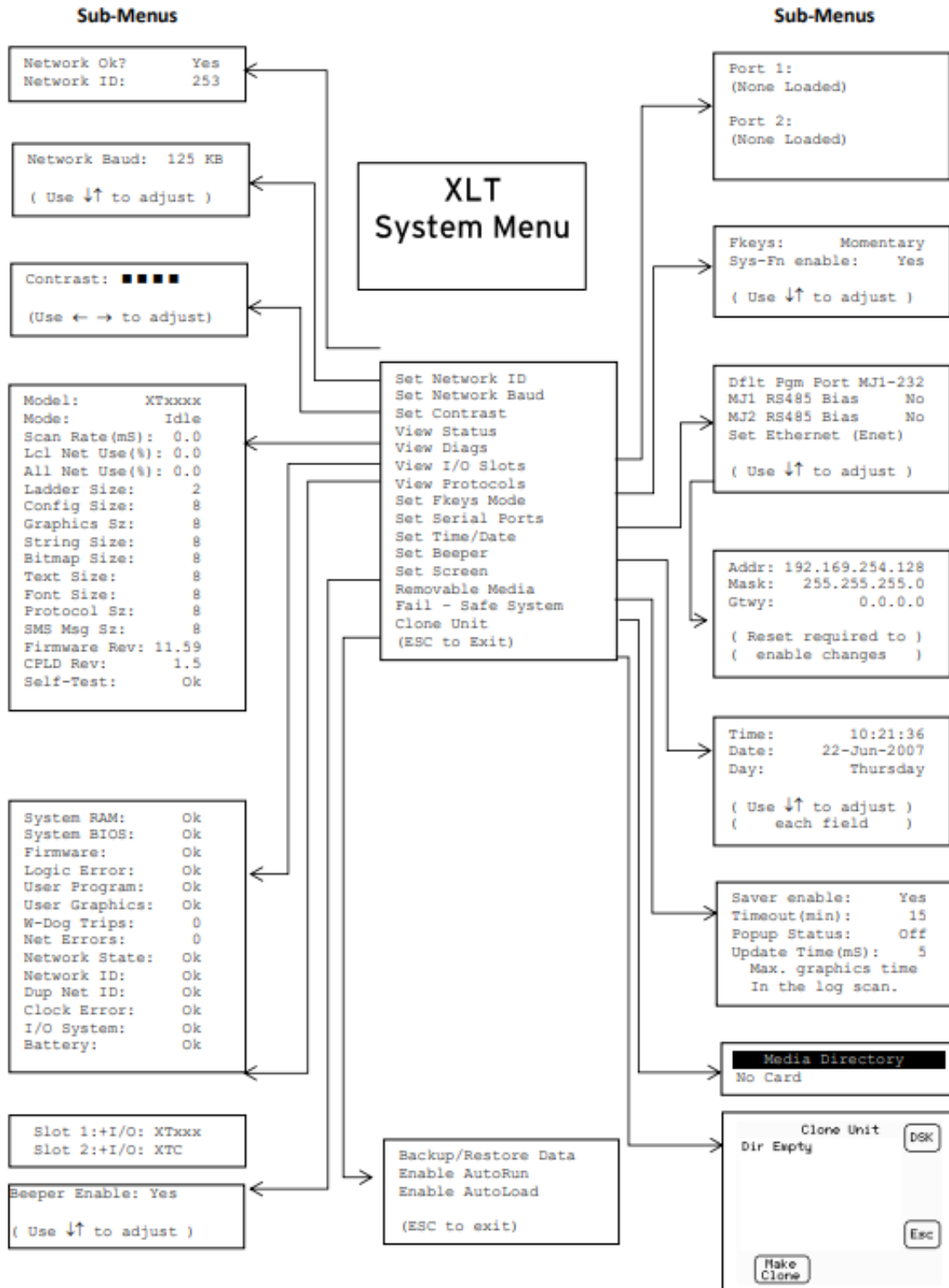

Set Network and Contrast

Set Network ID

The Network ID Sub-Menu only appears for XLE/XLT models that have CAN ports (XE1xx). This Sub-Menu displays two System Settings of which only Network ID is editable.

Set Network ID	
Network Ok?	Yes = NET1 connected to a CAN network and functioning properly No = Not ready to communicate on CAN network
Network ID	1 to 253 = This node's CsCAN Network ID; must be unique on network

Set Network Baud Rate

The Network Baud Sub-Menu only appears for XLE/XLT models that have CAN ports (XE1xx). This Sub-Menu displays just one System Setting and it is editable.

Set Network Baud Rate	
Network Baud?	125kB = 125kBd CAN network 250kB = 250kBd CAN network 500kB = 500kBd CAN network 1 MB = 1MBd CAN network

Set Contrast

The Set Contrast Sub-Menu displays just one System Setting and it is editable.

Set Contrast	
Contrast: ■ ■ ■ ■	= Current display contrast setting

View Status, Diags, I/O Slots and Protocols

View Status

The View Status Sub-Menu displays up to 17 System Settings. The Lcl Net Use % and All Net Use % System Settings only appear for XLE/XLT models that have CAN ports (XE1xx). Only the Mode System Setting is editable.

View Status	
Model:	XExyyz = 5 or 6 character Model number of this XLE/XLT unit x = 1 for models that have a CAN port 0 = no CAN port yy = the installed I/O module 00 = no I/O module z = the installed COM module N = no COM module
Mode:	Idle = XLE/XLT is in Idle mode DoIO = XLE/XLT is in Do I/O mode Run = XLE/XLT is in Run mode
Scan Rate(mS)	0.0 = XLE/XLT is not in Run mode 0.1 to 999.9 = Average number of mS for each ladder scan
Lcl Net Use %:	0.0 to 100.0 = CAN network bandwidth % used by this XLE/XLT node
All Net Use %:	0.0 to 100.0 = CAN network bandwidth % used by all nodes
Ladder Size:	x = Number of bytes in application ladder program
Config Size:	x = Number of bytes in application I/O configuration
Graphic Sz:	x = Number of bytes in application graphic screens
String Size:	x = Number of bytes in application string table
Bitmap Size:	x = Number of bytes in application bitmaps
Text Size:	x = Number of bytes in application text tables
Font Size:	x = Number of bytes in application font tables
Protocol Sz:	x = Number of bytes in application downloaded protocols
SMS Msg. Sz:	x = Number of bytes in application SMS protocol configuration
Firmware Rev:	Current firmware version
CPLD Rev:	Current CPLD (Complex Programmable Logic Device) version
Self-Test:	Ok = All power-on self-tests passed Fault = One or more power-on self-tests failed

View Diags

The View Diags Sub-Menu displays up to 14 System Diagnostics, all of which are not editable. The **Net Errors, Network State, Network ID** and **Dup Net ID** System Diagnostics only appear for XLE/XLT models that have CAN ports (XE1xx).

The first five System Diagnostics are critical. If any of them indicate a Fault condition, the XLE/XLT will not enter or remain in Run mode, and the problem must be investigated and corrected.

System Diagnostics - Critical	
System RAM:	Ok = System RAM power-up self-test passed Fault = System RAM power-up self-test failed
System BIOS:	Ok = System BIOS power-up self-test passed Fault = System BIOS power-up self-test failed
Firmware:	Ok = Firmware power-up self-test passed Fault = Firmware power-up self-test failed
Logic Error:	Ok = All executed ladder instructions are legal for loaded firmware Fault = A ladder instruction not supported by firmware was found
User Program:	Ok = Ladder program and I/O configuration loaded successfully Fault = Ladder program or I/O configuration not loaded or load failed

The last nine System Diagnostics are informational. If any of them indicate a Warning condition, the XLE/XLT can still enter and remain in Run mode, but the problem should be investigated and corrected.

System Diagnostics - Informational	
User Graphics	Ok = Application graphics objects loaded successfully Fault = Application graphics objects not loaded or load failed
W-Dog Trips:	0 = Watchdog timer has not tripped since the last power-up x = Number of times watchdog timer has tripped
Net Errors:	0 = No CAN network bus-off errors have occurred x = Number of CAN network bus-off errors that have occurred
Network State:	Ok = At least one other node was found on the CAN network Warning = No other nodes were found on the CAN network
Network ID:	Ok = This node's CAN Network ID is in the range 1 to 253 Warning = This node's CAN Network ID was out of range at power-up
Dup Net ID:	Ok = This node's Network ID is unique on the CAN network Warning = This node's Network ID is duplicated in another node
Clock Error:	Ok = Time and date have been set Warning = Time and date need to be set
I/O System:	Ok = I/O configuration matches the installed I/O and COM modules Warning = I/O configuration needs updating to match installed modules

View I/O Slots

The View I/O Slots Sub-Menu displays two System Settings, both of which are not editable.

Internal to the XLE/XLT, there is a CPU board, and up to two installed modules. Models XE000 and XE100 have no installed I/O or COM modules. All other models have an I/O module in Slot 1 and can have a user-installed COM module in Slot 2.

Depending on which I/O module is installed and which I/O module has been configured by Cscape, one of the following six System Settings should appear for **Slot 1**:

I/O Slot 1 - System Settings	
Slot 1: I/O: Empty	= No I/O module installed or configured
Slot 1: *Unsupported	= Unsupported I/O module installed
Slot 1: -I/O Missing	= No I/O module installed but an I/O module is configured
Slot 1: +I/O: XExy	= yy I/O module installed but no I/O module configured
Slot 1: ?I/O: XExy	= yy I/O module installed but another I/O module configured
Slot 1: I/O: XExy	= yy I/O module installed and configured properly

Depending on the COM module that is installed and the COM module that has been configured by Cscape, one of the following six System Settings appears for **Slot 2**:

I/O Slot 2 - System Settings	
Slot 2: I/O: Empty	= No COM module installed or configured
Slot 2: *Unsupported	= Unsupported COM module installed
Slot 2: -I/O Missing	= No COM module installed but an COM module is configured
Slot 2: +I/O: XzC	= yy COM module installed but no COM module configured
Slot 2: ?I/O: XzC	= yy COM module installed but another COM module configured
Slot 2: I/O: XzC	= yy COM module installed and configured properly

View Protocols

The View Protocols Sub-Menu displays two System Settings, both of which are not editable.

Both the MJ1 (Port 1) and MJ2 (Port 2) serial ports support downloadable protocols. To assign a downloadable protocol to an XLE/XLT serial port, select the Protocol Config item in Cscape's Program menu and then setup a protocol for Port 1 or Port 2 (or both). Refer to "Serial Communications" on page 105 for more details.

In the View Protocols Sub-Menu, the currently downloaded protocol, if any, and its version number are displayed for both **Port 1** and **Port 2**.

Port 1 - Protocol	
Protocol Name	= (None Loaded) or name of the protocol assigned to MJ1
Protocol Version	= Blank or version of the protocol assigned to MJ1

Port 2 - Protocol	
Protocol Name	= (None Loaded) or name of the protocol assigned to MJ2
Protocol Version	= Blank or version of the protocol assigned to MJ2

Set Keys, Serial Ports, Ethernet, Time/Date and Beeper

Set Keys

The Set Fkeys Sub-Menu displays two System Settings, both of which are editable.

Fkeys:	
Momentary	= %K1-10 bits go On & Off as F1-F10 are pressed & released
Toggle	= %K1-10 bits toggle each time F1-F10 are pressed

SYS_Fn enable	
Yes	= Reset and all clear system functions enabled
No	= Reset and all clear system functions disabled

Set Serial Ports

The Set Serial Ports Sub-Menu displays three System Settings; all of which are editable, and one optional item. For the Dflt Pgm Port System Setting, only MJ1-232 can be selected, unless either an Ethernet (XEC) or a Modem (XMC) COM module is installed. Also, the Set Ethernet (Enet) item only appears if an Ethernet COM module is installed.

Dflt Pgm Port	
MJ1-232	= MJ1 RS232 port is the default programming port
Enet	= Ethernet COM module is the default programming port
Modem	= Modem COM module is the default programming port
MJ1 RS485 Bias	
No	= MJ1 RS485 bias resistors are not switched in
Yes	= MJ1 RS485 bias resistors are switched in
MJ2 RS485 Bias	
No	= MJ2 RS485 bias resistors are not switched in
Yes	= MJ2 RS485 bias resistors are switched in

Set Ethernet (Enet)	
= Select and press Enter to setup the Ethernet COM module	

Set Ethernet (Enet) (for units older than Rev TA)

The Set Ethernet (Enet) Sub-Menu displays three System Settings, all of which are editable. The values shown below are the default values. **NOTE:** If Gtwy is set to 0.0.0.0, Ethernet communication will be confined to the local network.

Set Ethernet (XLEe & XLTe only)	
Addr:	192.168.254.128 = IP Address for installed Ethernet COM module
Mask:	255.255.255.0 = Net Mask for installed Ethernet COM module
Gtwy:	0.0.0.0 = Gateway device IP Address for installed Ethernet COM module

Set Time/Date

The Set Time/Date Sub-Menu displays three System Settings. Time and Date are editable, and Day is automatically calculated from the Date setting. **NOTE:** Time and Date are split into three editable fields each. Use ← or → to select a field and then use ↓ or ↑ to edit the field.

Set Time/Date	
Time:	10:21:36 = Current time (hours:minutes:seconds in 24-hour format)
Date:	22-Jun-2022 = Current date (day-month-year)
Day:	Thursday = Current day of week calculated from the Date setting

Set Beeper (XLT or XLTe only)

NOTE: Does not apply to XLE or XLEe. The Set Beeper Sub-Menu displays one System Setting, which is editable

Beeper Enable	
Yes (default)	= Enables beeper
No	= Disables beeper (does NOT affect ladder access)

Removable Media

See also: "Removable Media" on page 136

Format a microSD Card

1. Select Removable Media in the System Menu of the controller.
2. Place card in the "Memory" slot.
3. Final Step:
 - a. For XLE, press the bottom right soft key to get the submenu that includes "format", select format.
 - b. For XLT, press the bottom left and right keys to get the sub menu that includes "format", select format.

XLE/XLEe Removable Media Sub-Menu

The Removable Media Sub-Menu displays the Removable Media. Refer to "Removable Media" on page 136 for more details. After selecting Removable Media from the Main Menu, one of four Sub-Menu screens will appear:

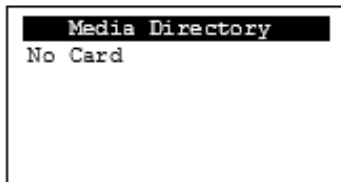

= No microSD card has been installed in the Memory slot

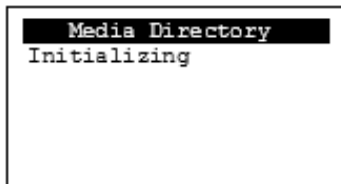

= microSD card is installed, but it is still initializing

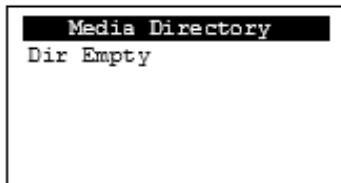

= microSD card is installed and initialized, but contains no files

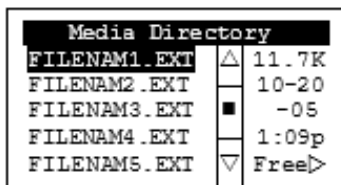

= microSD card is installed and initialized, and it contains files

Shows size of highlighted file or shows <DIR> if directory is highlighted

Shows the date file or directory was created or last modified

Shows the time file or directory was created or last modified

Scrollbar only appears if displayed directory contains more than five files and/or directories.

Shows up to five files or directory names at a time

If the Removable Media Manager displays files or directories, as in the last example above, there are several options available:

- a. If → is pressed, the number of total and free bytes is displayed. Then, pressing ← returns to the normal file and directory display.
- b. If a soft key (on either side of the display) is pressed, a pop-up window appears on the right side of the display, showing the function key options as follows:

RM Function Keys	
F1 Delete	= Delete the highlighted file or directory
F2 DelAll	= Delete all files and directories
F3 Format	= Format the microSD card
F4 SavPgm	= Save XLE/XLT application to DEFAULT.PGM
Esc Cancel	= Cancel current operation (back up one screen)

Pressing the soft key again or pressing ESC returns to the normal file and directory display.

- c. If a directory name is highlighted, pressing Enter will switch to that directory showing its files and sub-directories. In a sub-directory, highlighting .. (dot dot) and pressing Enter will move up one directory.

XLT/XLTe Removable Media Sub-Menu

The Removable Media Sub-Menu displays the Removable Media Manager. Refer to "Removable Media" on page 136 for more details. After selecting Removable Media from the Main Menu, one of four Sub-Menu screens will appear:

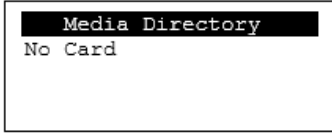

= No microSD card has been installed in the Memory slot

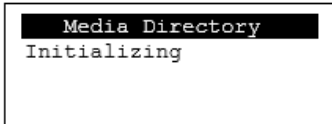

= microSD card is installed, but it is still initializing

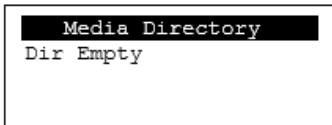

= microSD card is installed and initialized, but contains no files

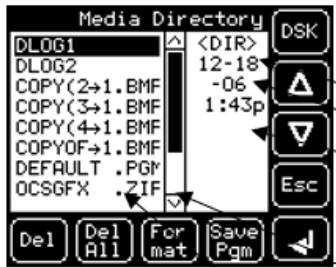

= microSD card is installed and initialized, and it contains files

Shows size of highlighted file or shows <DIR> if directory is highlighted





Shows date the file or directory was created or last modified

Shows time the file or directory was created or last modified

Scrollbar only appears if displayed directory contains more than five files and/or directories.

Shows up to five file or directory names at a time

If the Removable Media Manager displays files or directories, there are several options available:

	Delete	= Delete the highlighted file or directory
	DelAll	= Delete all files and directories
	Format	= Format the microSD card
	SavPgm	= Save XLT application to DEFAULT.PGM
		= Enter Key
	DSK	= Shows number of total and free bytes in removable memory
		= Up Arrow
		= Down Arrow
	Esc	= Cancel current operation (back up one screen)

Pressing Esc returns to the normal file and directory display.

If a directory name is highlighted, pressing Enter will switch to that directory showing its files and sub-directories. In a sub-directory, highlighting .. (dot dot) and pressing Enter will move up one directory.

Fail-Safe System

See also: "Fail-Safe System" on page 149

The Fail-Safe System is a set of features that allow an application to continue running in the event of certain types of "soft" failures. These "soft" failures include:

- Battery power loss
- Battery-Backed Register RAM or Application Flash corruption due to, for example, an excessive EMI, Electromagnetic Interference, event.

Selecting "Fail-Safe System" menu will open the following menu screen:

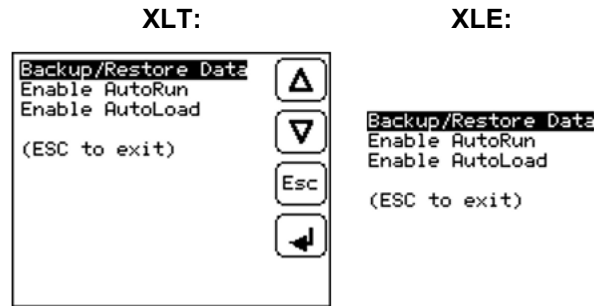

Selecting Backup/Restore Data displays the following screen:

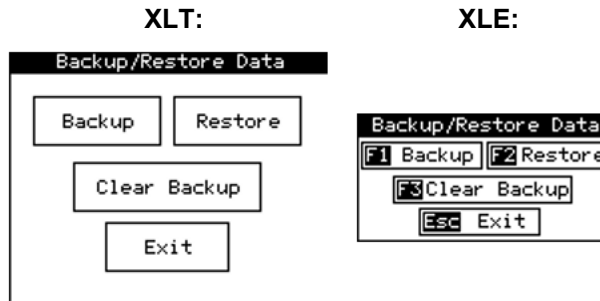

Fail-Safe Functions	
Backup	= Copies Battery Backed RAM contents on to the onboard flash memory of the OCS.
Restore	= Copies the backed-up data from onboard flash to the battery backed RAM.
Clear Backup	= The backup data will be erased from the onboard flash.
Exit	= Goes back to previous menu.

AutoRun

Selecting AutoRun displays the following screen.

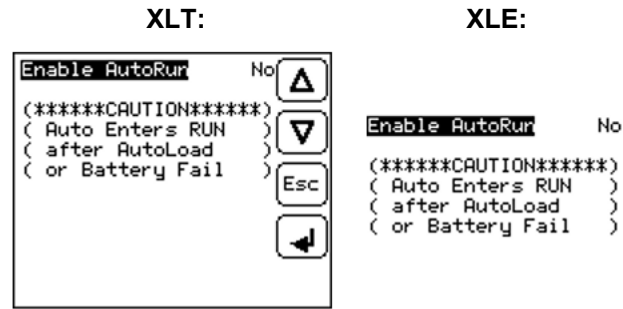

AutoRun	
No	= OCS will be in IDLE mode after AutoLoad or Automatic Restore.
Yes	= OCS will be automatically placed into RUN mode after AutoLoad or Automatic Restore.

AutoLoad

Selecting AutoLoad displays the following screen.

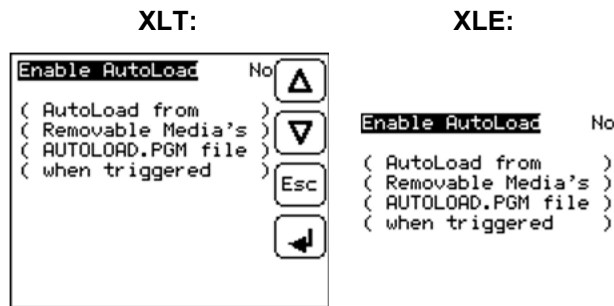

AutoLoad	
No	= Does not load AUTOLOAD.PGM automatically when application program is absent or corrupted.
Yes	= Loads AUTOLOAD.PGM file automatically from RM when application program is absent or corrupted.

Clone Unit

See also: "Clone Unit" on page 143

'Clone Unit' feature allows the user to "clone" the OCS of the exact same model. This feature "clones" application program and unit settings stored in Battery backed RAM of an OCS into the RM. Refer to "Clone Unit" on page 143 for more details. It can then be used to clone a different OCS (exact same model).

This feature can be used for:

- Replacing an OCS by another unit of the same model.
- Duplicating or "clone" units without a PC.

Selecting **Clone Unit** displays the following screen:

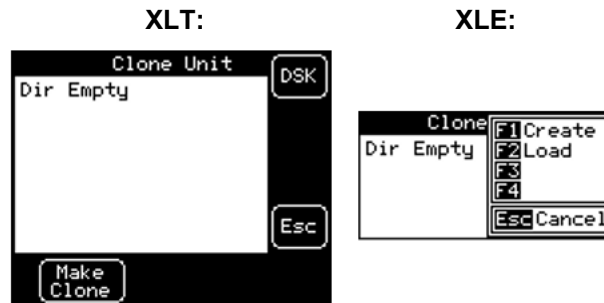

NOTE:

- a. In the above Figure, F3 and F4 (XLE menu) are inactive in Clone Unit.
- b. DSK – when selected shows number of total and free bytes in Removable Media.

Make Clone

Selecting **Make Clone** displays the following screen.

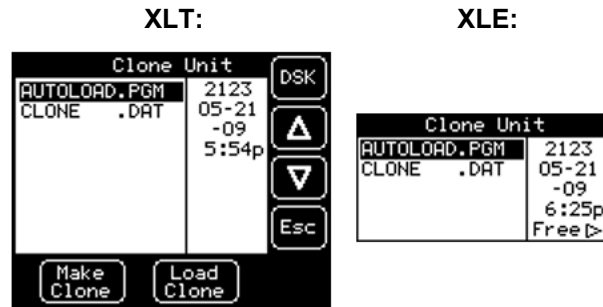

Make Clone	
AUTOLOAD.PGM	Application file
CLONE.DAT	File having all unit settings and register values from Battery Backed RAM

Load Clone

Selecting **Load Clone** displays the following screen.

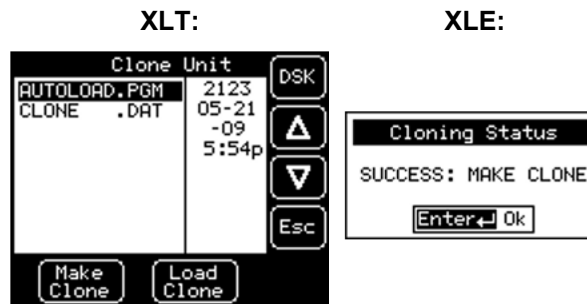

NOTE: For security enabled files, Load Clone asks for password validation before loading the application.

Touch Screen Calibration for XLT/XLTe

NOTE: This does not apply for the XLE/XLEe

The touch screen is calibrated at the factory and rarely needs modification. However, if actual touch locations do not appear to correspond with responding objects on the display, field adjustment is available. Ensure SYS_fn Enable is set to YES in System Menu. To access the field adjustable touch screen calibration dialog, press and hold both the SYS and F1 key for longer than 2 seconds and a dialog similar to the figure below should appear. Thereafter, use a plastic tip stylus and follow the dialog instructions.

For best results in screen calibration, use a stylus with a plastic tip. When the crosshair appears, touch the center of the crossbar as exactly as possible and release. A small "+" should appear and will move closer to the center of the crosshair. Once it has done so and disappeared again, repeat the process until "+" appears in the center of the crosshair. Then move on to the next step.

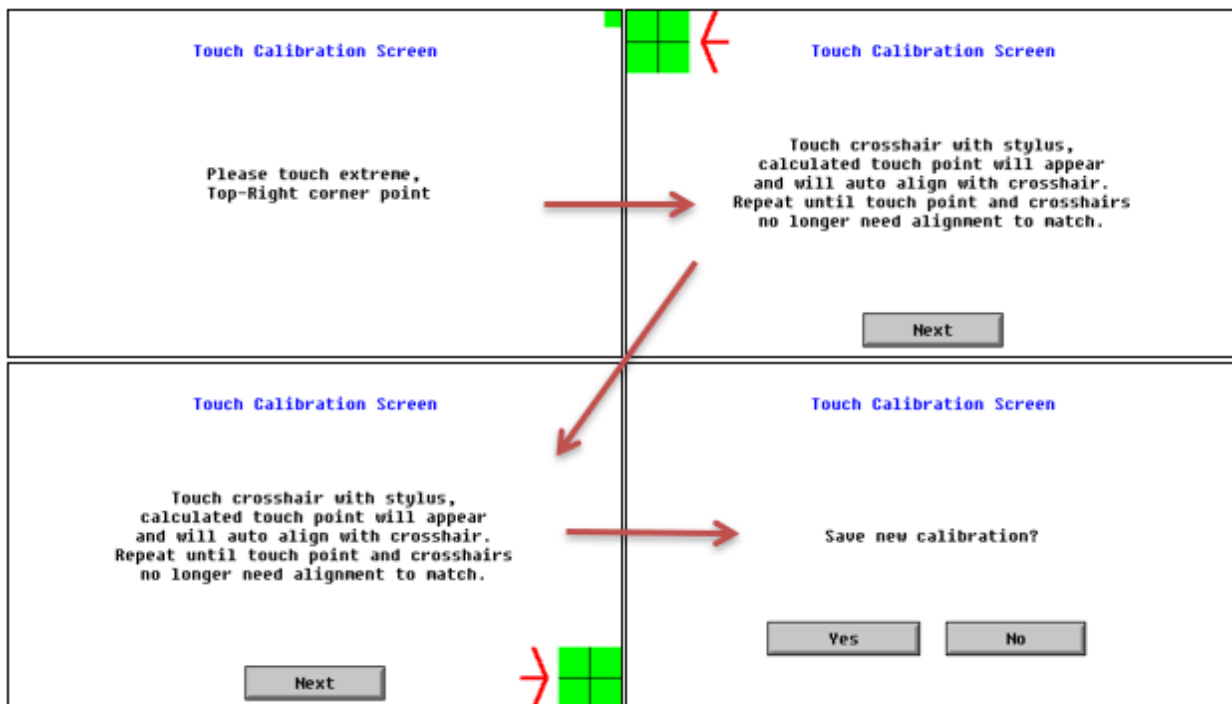

System Registers



System Register Tables

Register Definitions	45
%S Registers	46
%SR Registers	47
I/O Register Map for XLE/XLT	54
XLE/XLT Resource Limits	55

For I/O Register Maps for individual controllers, refer to the Horner website [Document Search](#) page.

There are two types of System Registers that may be used during programming. %S registers indicate the status of several system operations. %SR registers indicate the state of many system operations and can be used to control them in several cases. Some of the system registers have predefined I/O names, though they may still be changed if desired.

Register Definitions

When programming the an OCS, data is stored in memory that is segmented into different types. This memory in the controller is referred to as registers. Different groups of registers are defined as either bits or words (16 bits). Multiple registers can usually be used to handle larger storage requirements. For example, 16 single-bit registers can be used to store a word, or two 16-bit registers can be used to store a 32-bit value.

Types of Registers	
%AI = Analog Input	16-bit input registers used to gather analog input data such as voltages, temperatures, and speed settings coming from an attached device.
%AQ = Analog Output	16-bit output registers used to send analog information such a voltages, levels or speed settings to an attached device.
%D = Display Bit	These are digital flags used to control the displaying of screens on a unit which has the ability to display a screen. If the bit is SET, the screen is displayed.
%I = Digital Input	Single-bit input registers. Typically, an external switch is connected to the registers.
%K = Key Bit	Single-bit flags used to give the programmer direct access to any front panel keys appearing on a unit.
%M = Retentive Bit	Retentive single-bit registers.
%Q = Digital Output	Single-bit output registers. Typically, these bits are connected to an actuator, indicator light or other physical outputs.
%R = General Purpose Register	Retentive 16-bit registers.
%S = System Bit	Single-bit bit coils predefined for system use.
%SR = System Register	16-bit registers predefined for system use.
%T = Temporary Bit	Non-retentive single-bit registers.

%S Registers

%S registers indicate system status as follows:

%S Registers			
S#	Name	Predefined I/O Name	Notes
%S1	First Scan	FST_SCN	On for 1 scan only each time the program is first run
%S2	Network OK	NET_OK	If on, the Network is OK
%S3	10ms pulse	T_10MS	Cycling pulse that is high for 5ms and low for 5ms
%S4	100ms pulse	T_100MS	Cycling pulse that is high for 50ms and low for 50ms
%S5	1 second pulse	T_1SEC	Cycling pulse that is high for 500ms and low for 500ms
%S6	I/O OK	IO_OK	If on, the I/O system is OK
%S7	Always On	ALW_ON	This bit is always on
%S8	Always OFF	ALW_OFF	This bit is always off
%S9	Pause Scan	PAUSING_SCN	On for at least 1 scan prior to Pause 'n Load
%S10	Resume Scan	RESUMED_SCN	On for 1 scan only after Pause 'n Load is done
%S11	Forcing Present	FORCE	If on, I/O is presently being forced
%S12	Forcing Enabled	FORCE_EN	If on, I/O forcing is been enabled
%S13	Net I/O OK	NET_IO_OK	If on, Network I/O is OK

%SR Registers

%SR registers are special word-length registers that display and/or control system operations in the controller. Not all controllers support all defined system registers.

XLE & XLT %SR Registers					
SR #	Name and Description	Default I/O Name	Min - Max Values	Program (Read/Write)	Display (Read/Write)
%SR1	User Screen Number (0=none)	USER_SCR	0 to 1023	Read/Write	Read/Write
%SR2	Alarm Screen Number	ALRM_SCR	0 to 1-23	Read Only	Read Only
%SR3	System Screen Number 1 = Main System Menu 2= Set Network ID, Network Status, (%SR29) 3= Set Network Baud (%SR30) 4= Set Contrast (%SR32) 5= View OCS Status 6= View OCS Diagnostics 7= View I/O Slots 8= Set Function Key Mode (%SR33) 9= Set Serial Ports (%SR34) 10= Set Time/Date (%SR44-%SR50) 11= Set Beeper (%SR183) 12= Set Screen (%SR185) 13= Removable Media 14= View Protocols 15= IP Address IP Address (ETN I/O Board) 16= Fail Safe System 17= Backup / Restore Data 18= Enable AutoRun 19= Enable AutoLoad 20= Clone Unit - 21= Touch Calibration 24= License Details	SYS_SCR	0 to 24	Read/Write	Read/Write
%SR4	Self Test Results	SELF_TEST		Read Only	Read Only
%SR4.1	Self Test Results - BIOS Error			Read Only	Read Only
%SR4.2	Self Test Results - Engine Error			Read Only	Read Only
%SR4.3	Self Test Results - Ladder Error			Read Only	Read Only
%SR4.4	Self Test Results - RAM Error			Read Only	Read Only
%SR4.5	Self Test Results - Duplicate ID Error			Read Only	Read Only
%SR4.6	Self Test Results - Bad ID Error			Read Only	Read Only
%SR4.7	Self Test Results - I/O Configuration Error			Read Only	Read Only
%SR4.8	Self Test Results - Bad Network Error			Read Only	Read Only
%SR4.9	Self Test Results - Bad Logic Error			Read Only	Read Only
%SR4.10	Self Test Results - Bad Clock Error			Read Only	Read Only
%SR4.11	Self Test Results - DeviceNet Error			Read Only	Read Only
%SR4.12 - 16	Reserved				
%SR5	Control Station Mode 0= Idle 1= Do I/O	CS_Mode	0 to 3	Read Only	Read/Write

XLE & XLT %SR Registers						
	2= Run 3= Online Change					
%SR6	Average Scan Rate ms (/ 10)			Read Only	Read Only	
%SR7	Minimum Scan Rate ms (/ 10)			Read Only	Read Only	
%SR8	Maximum Scan Rate ms (/ 10)			Read Only	Read Only	
%SR9	Current Touch Pressure	TCH_ PRESSURE	0 to 3000	Read Only	Read Only	
%SR10	Threshold Touch Pressure	TCH_ PRESSURE_ TSH	0 to 3000	Read/Write	Read/Write	
%SR11-12	Ladder Size (32-Bit DINT)			Read Only	Read Only	
%SR13-14	User Text Screen Size (32-Bit DINT)			Read Only	Read Only	
%SR15-16	System Text Screen Size (32-Bit DINT)			Read Only	Read Only	
%SR17-18	I/O Configuration Table Size (32-Bit DINT)			Read Only	Read Only	
%SR19-20	Network Config Table Size (32-Bit DINT)			Read Only	Read Only	
%SR21-22	Security Data Table Size (32-Bit DINT)			Read Only	Read Only	
%SR23	Ladder Code CRC			Read Only	Read Only	
%SR24	User Text CRC			Read Only	Read Only	
%SR25	System Text CRC			Read Only	Read Only	
%SR26	I/O Configuration Table CRC			Read Only	Read Only	
%SR27	Network Configuration Table CRC			Read Only	Read Only	
%SR28	Security Data Table CRC			Read Only	Read Only	
%SR29	Network ID	NET_ID	1 to 253	Read Only	Read/Write	
	CsCAN Mode					
	DeviceNet Mode					0 to 63
	CANopen Mode					1 to 127
%SR30	Network Baud Rate 0=125KB 1= 250kB 2= 5000KB 3= 1MB 4=50K		0 to 4	Read Only	Read/Write	
%SR31	Network Required 0= Network not required 1= Network required; 2= Network optimized; 3= Network required and optimized		0 to 3	Read Only	Read Only	
%SR32	LCD Display Contrast setting		0 to 255	Read Only	Read/Write	
%SR33	Function Key Toggle Mode 0= Momentary 1= Toggle		0 to 1	Read/Write	Read/Write	
%SR34	RS232 Serial Protocol Mode 0= Firmware Update (RISM) 1= CsCAN 2= Generic (Ladder- Controlled) 3= Modbus RTU 4= Modbus ASCII			Read Only	Read Only	

XLE & XLT %SR Registers					
%SR35-36	Unique Serial Number / Hexadecimal I LAN1 MAC ID			Read Only	Read Only
%SR37	Model Number			Read Only	Read Only
%SR38	Engine Version (/100)			Read Only	Read Only
%SR39	BIOS Rev Number (/ 100)			Read Only	Read Only
%SR40	FPGA Image Rev Number (/ 10)			Read Only	Read Only
%SR41	Vertical Pixel Count			Read Only	Read Only
%SR42	Horizontal Pixel Count			Read Only	Read Only
%SR43	Keypad Type			Read Only	Read Only
%SR44	Real-Time-Clock Second	RTC_SEC	0 to 59	Read Only	Read Only
%SR45	Real-Time-Clock Minute	RTC_MIN	0 to 59	Read Only	Read Only
%SR46	Real-Time-Clock Hour	RTC_HOUR	0 to 23	Read Only	Read Only
%SR47	Real-Time-Clock Date	RTC_DATE	1 to 31	Read Only	Read Only
%SR48	Real-Time-Clock Month	RTC_MONTH	1 to 12	Read Only	Read Only
%SR49	Real-Time-Clock Year	RTC_YEAR	1996 to 2095	Read Only	Read Only
%SR50	Real-Time-Clock Day (1=Sunday)	RTC_DAY	1 to 7	Read Only	Read Only
%SR51	Network Error Count			Read Only	Read Only
%SR52	Watchdog-Tripped Error Count			Read Only	Read Only
%SR53-54	Reserved				
%SR55.13	Self-Test: Battery Low or Missing			Read Only	Read Only
%SR56	Key Currently Pressed No key = 0 (No key pressed since power-up) F1 = 1 F2= 2 F3= 3 F4 = 4 F5= 5 F6= 6 F7=7 F8= 8 F9= 9 F10 = 10 F11= 11 F12 = 12 Enter = 13 +/- = 14 . (dot) = 15 0 = 16 1 = 17 2 = 18 3 = 19 4 = 20 5 = 21 6 = 22 7= 23 8 = 24 9 = 25 System = 26 Escape = 27 Left = 28 Right = 29 Up = 30 Down = 31 Shift = 32	LAST_KEY	0 to 255	Read Only	Read Only

XLE & XLT %SR Registers					
	Soft Key 1 = 34 Soft Key 2 = 35 Soft Key 3 = 36 Soft Key 4 = 37 Soft Key 5 = 38 Soft Key 6 = 39 Soft Key 7 = 40 Soft Key 8 = 41 Release = 255 (Keys pressed since power-up but not currently)				
%SR57	LCD Backlight Dimmer Register 0-100 = 0% to 100% On 100-255 = 100% On		0 to 255	Read Only	Read Only
%SR57.16	Temporarily disable Screen Saver			Read/Write	Read/Write
%SR58	User LEDs	USER_LEDS		Read/Write	Read/Write
%SR59	Engine Build Number (Only last three numbers displayed)			Read Only	Read Only
%SR60	Build Option Build Test = 0 Build Beta = 1 Build Product = 2		0 to 2	Read Only	Read Only
%SR61	Number of CsCAN Network IDs	NUM_IDS		Read Only	Read Only
%SR62-100	Reserved				
%SR101.3	WebMI License Details – WebMI server status XLEe & XLTe only			Read Only	Read Only
%SR101.4	WebMI License Details – WebMI user logged in status XLEe & XLTe only			Read Only	Read Only
%SR101.8 - 101.16	WebMI License Details – Number of users XLEe & XLTe only			Read Only	Read Only
%SR102 - 107	Reserved				
%SR108	WebMI License Details – Number of webpages XLEe & XLTe only			Read Only	Read Only
%SR109	WebMI License Details – Number of datapoints XLEe & XLTe only			Read Only	Read Only
%SR110-112	WebMI License Details – Expiry date of WebMI license XLEe & XLTe only			Read Only	Read Only
%SR113-130	Reserved				
%SR131-135	OCS Model: ASCII, 10 characters			Read Only	Read Only
%SR136	Communication Download Timeout			Read Only	Read Only
%SR137	Communication Idle Timeout			Read Only	Read Only
%SR138-148	Reserved				
%SR149-150	Free-running 10kHz count: 1 count = 0.1ms (32-Bit DINT)			Read Only	Read Only

XLE & XLT %SR Registers					
%SR151	Reserved				
%SR152	RS-485 Termination			Read/Write	Read/Write
%SR152.1	MJ2 Termination Enable			Read/Write	Read/Write
%SR152.2	Reserved				
%SR152.3	MJ1 Termination Enable			Read/Write	Read/Write
%SR152.4	Reserved			Read/Write	Read/Write
%SR153 - 163	Reserved				
%SR164	FailSafe / clone				
%SR164.1	RS485 Port Biasing #1 (MJ1 or MJ2)			Read/Write	Read/Write
%SR164.2	RS485 Port Biasing #2 (MJ2 or MJ3)			Read/Write	Read/Write
%SR164.3	Indicates Automatic Restore Operation has been performed	AUTO_RESTRD		Read Only	Read Only
%SR164.4	Indicates Backup of Registers has been taken	BCKUP_TAKN		Read Only	Read Only
%SR164.5	Enable AUTORUN – Sets “Enable AutoRun” to “Yes” or “No”	EN_AUTO_LD		Read/Write	Read/Write
%SR164.6	Enable AUTOLOAD – Sets “Enable AutoLoad” to “Yes” or “Not”	EN_AUTO_LD		Read/Write	Read/Write
%SR164.7	Start Backup trigger bit – Setting TRUE starts backup of all register data	STRT_BCKUP		Read/Write	Read/Write
%SR164.8	Clear Backup trigger bit – Setting TRUE clears backup of all register data (if a backup was done previously)	CLR_BACKUP		Read/Write	Read/Write
%SR164.9	MAKE_CLONE trigger bit = Setting TRUE does a Load Clone (if a media card is present)	MAKE_CLONE		Read/Write	Read/Write
%SR164.10	LOAD_CLONE trigger bit – Setting TRUE does a LOAD CLONE (if a media card is present that contains clone files)	LOAD_CLONE		Read/Write	Read/Write
%SR164.11	Make Clone Fail (This bit goes high when Make/Create Clone fails)	MK_CLN_FL		Read/Write	Read/Write
%SR164.12	Load Clone Fail (This bit goes high when Load Clone fails)	LD_CLN_FL		Read/Write	Read/Write
%SR164.14	Reserved			Read/Write	Read/Write
%SR164.15	Reserved			Read/Write	Read/Write
%SR165-166	Reserved				
%SR167	Screen Update Time, Default= 5		2 to 50	Read/Write	Read/Write
%SR168-170	Reserved				
%SR171	X-Coordinate Touched			Read Only	Read Only
%SR172	Y-Coordinate Touched			Read Only	Read Only
%SR173	System-Function Disable		0 to 1	Read/Write	Read/Write
%SR174	Removable Media Protect			Read/Write	Read/Write
%SR174.1	Request Media Card be Removed			Read/Write	Read/Write
%SR174.2	Indicates safe to remove Media Card			Read/Write	Read/Write
%SR175	Removable Media - Status			Read Only	Read Only
%SR176-177	Removable Media Free Space (32-Bit			Read Only	Read Only

XLE & XLT %SR Registers					
	DINT)				
%SR178-179	Removable Media Total Space (32-Bit DINT)			Read Only	Read Only
%SR180	Reserved				
%SR181	Bits 1-16 indicate Unacknowledged in Alarm Groups 1-16	ALM_UNACK		Read Only	Read Only
%SR182	Bits 1-16 indicate Active in Alarm Groups 1-16	ALM_ACT		Read Only	Read Only
%SR183	Beep on Keypress Enable 0= Disabled 1= Enabled	SYS_BEEP	0 to 1	Read/Write	Read/Write
%SR184	Internal Beeper 0=OFF 1=ON	USER_BEEP	0 to 1	Read/Write	Read/Write
%SR185	Screen Saver Enabled 0= Disabled 1= Enabled NOTE: See %SR57.16		0 to 1	Read Only	Read Only
%SR186	Screen Saver Time in minutes (delay)		5 to 1200	Read Only	Read Only
%SR187	Network Usage (Avg)	NET_USE	0 to 1000	Read Only	Read Only
%SR188	Network Usage (Min)		0 to 1000	Read Only	Read Only
%SR189	Maximum Net Usage of all units on the CAN network		0 to 1000	Read Only	Read Only
%SR190	Network TX Usage % (/ 10) (Avg)	NT_TX_AVG	0 to 1000	Read Only	Read Only
%SR191	Network TX Usage % (/ 10) (Min)		0 to 1000	Read Only	Read Only
%SR192	Network TX Usage % (/ 10) (Max)		0 to 1000	Read Only	Read Only
EXTENDED SYSTEM REGISTERS					
%SR193	Online Change	ONLINE_CHG			
%SR193.1	TRUE if 2 programs in target FLASH			Read Only	Read Only
%SR193.2	TRUE to switch programs, FALSE when complete			Read Only	Read Only
%SR193.3	TRUE if executing program is temporary test			Read Only	Read Only
%SR193.4	TRUE during last scan of switched-from program			Read Only	Read Only
%SR193.5	TRUE during first scan of switched-to program			Read Only	Read Only
%SR193.6	TRUE to revert to FLASH and delete all RAM; FALSE when complete			Read Only	Read Only
%SR193.9	TRUE if error in temporary program			Read Only	Read Only

XLE & XLT %SR Registers					
%SR194	Battery Charge Temp Low			Read Only	Read Only
%SR195	Battery Charge Temp High			Read Only	Read Only
%SR196	Charging State NOTE: Refer to MAN1142 for more details on Rechargeable Batteries 0=Waiting 1=Normal Charging 2=Hot Charge 3=Hot Charge 4= Battery Hot 5= Cold Charge 6=Battery Cold 7=No Battery 8= Not Charging (after 8 hours of charging) 9= CPU Hot, not charging 10 Battery voltage <2V, not charging 11= First 2 minutes Init Wait (Not Charging)		0 to 11	Read Only	Read Only
%SR197	Charging Current Max mA			Read Only	Read Only
%SR198	Battery Voltage is mV			Read Only	Read Only
%SR199	Reserved				
%SR200	InitRD Version (/100)			Read Only	Read Only
%SR201 - 205	Linux Kernel version: ASCII, 10 characters			Read Only	Read Only
%SR206-208	Reserved				
%SR209.3	WebMI Server Status. Bit 3 is ON if server running.			Read Only	Read Only
%SR209.4	WebMI User Logged in Status. Bit 4 is ON if 1 or more users logged in.			Read Only	Read Only
%SR209.8 - 209.14	Number of Users. Shows in upper byte in decimal format.			Read Only	Read Only
%SR210	Time Zone: set in minutes +/-UTC (Ex: EST is -4 hours = -240 minutes)			Read/Write	Read/Write
%SR211	Daylight Saving: YES = 1 Daylight Saving: NO = 0 (If daylight saving is enabled, one hour will be added to the local time).			Read/Write	Read/Write
%SR212	UTC - Seconds			Read Only	Read Only
%SR213	UTC - Minutes			Read Only	Read Only
%SR214	UTC - Hours			Read Only	Read Only
%SR215	UTC - Date			Read Only	Read Only
%SR216	UTC - Month			Read Only	Read Only
%SR217	UTC - Year			Read Only	Read Only
%SR218	Reserved				
%SR219	Reserved				
%SR220-222	Reserved				

I/O Register Map for XLE/XLT

NOTE: These registers can be used as general purpose registers

Registers	Description					
	XLE/XLT with no I/O	XLE/XLT with 102 I/O	XLE/XLT with 103 I/O	XLE/XLT with 104 I/O	XLE/XLT with 105 I/O	XLE/XLT with 106 I/O
%I1-%I12	Unused	Digital Inputs				
%I13-%I16	Unused	Reserved		Digital Inputs	Reserved	
%I17-%I24	Unused		Reserved	Digital Inputs	Reserved	
%I25-%I31	Unused		Reserved			
%I32	Unused		Output Fault	Output Fault	Output Fault	Reserved
%Q1-%Q6	Unused	Digital Outputs				
%Q7-%Q12	Unused	Reserved	Digital Outputs			
%Q13-%Q16	Unused	Reserved		Digital Outputs	Reserved	
%Q17	Unused	Totalizer: Clear HSC1, Quadrature: Clear Quad1				
%Q18	Unused	Totalizer: Clear HSC2, Quadrature: Set Quad1				
%Q19	Unused	Totalizer: Clear HSC3, Quadrature: Clear Quad2				
%Q20	Unused	Totalizer: Clear HSC4, Quadrature: Set Quad2				
%Q21-%Q24	Unused	Reserved				
%AI1-%AI4	Unused	Analog Inputs	Reserved			
%AI5-%AI6	Unused	HSC1 Accumulator				
%AI7-%AI8	Unused	HSC2 Accumulator				
%AI9-%AI10	Unused	HSC3 Accumulator				
%AI11-%AI12	Unused	HSC4 Accumulator				
%AI33 - %AI38	Unused					Analog Inputs
%AQ1-%AQ2	Unused		PWM1 Duty Cycle			
%AQ3-%AQ4	Unused		PWM2 Duty Cycle			
%AQ5-%AQ6	Unused		PWM Prescale			
%AQ7-%AQ8	Unused		PWM Period			
%AQ9-%AQ10	Unused				Analog Outputs	

XLE/XLT Resource Limits

Resource	Value
%S	13
%SR	192
%T	2048
%M	2048
%R	9999
%K	10
%D	1023
%I	2048
%Q	2048
%AI	512
%AQ	512
%IG	64
%QG	64
%AIG	32
%AQG	32
Network Ports	CsCAN (Optional depending on model)
Controllers Per Network	253
Keypad	20 keys (10 fn keys and 4 soft keys)
Display	128x64 LCD Backlit, monochrome for XLE 160x128 LCD Backlit, monochrome for XLT
Screen Memory	1M
User Screens	1023
Data Fields Per User Screen	50
Ladder Code	256k

Cscape Configuration



Cscape Configuration

XLE & XLT Background	57
Cscape Status Bar	58
Establishing Communications	59
Cscape Configuration	65

XLE & XLT Background

XLE/XLT hardware is programmed with a Windows based PC application called Cscape. This application can be used to program, configure, monitor and debug all aspects of the XLE/XLT unit. Please see the on-line help provided with Cscape for additional details.

Updating Programs from First Generation to Second Generation XLE/XLT

Generation 1 products did not feature integrated Ethernet, so if the part number contains an E like HE-XT1E0 or HE-XE1E6 it is a second generation unit. Devices without integrated Ethernet can be checked using the hardware revision after the part number. Hardware revision "T" and later are Generation 2 products. For example, XE-XE103TB is hardware revision "T."

Cscape programs created for the first generation XLE and XLT can be loaded into Generation 2 products without any changes.

If you created PGM files to be loaded into XLE or XLT devices via the microSD card, then these can be used.

If your configuration contains no downloadable protocols, then you can use the PGM without any changes.

If your PGM contains downloadable protocols, then you can either recreate the PGM with Cscape 9.8 or later, or you can use the PGM Update utility that distributes with Cscape 9.8 or later. The utility is located in the main Cscape folder and is called **PGMUpdateUtility.exe**. Running this allows inputting the old PGM filename and it will update it to a new file for download into Generation 2 (Rev T or later) products.

Cscape Status Bar

When the XLE/XLT is connected to a PC using Cscape software a Status Bar appears at the bottom of the screen. The Cscape Status Bar can be used to determine if communications have been established between the XLE/XLT and the Cscape program. Components of the Cscape Status Bar are explained below.

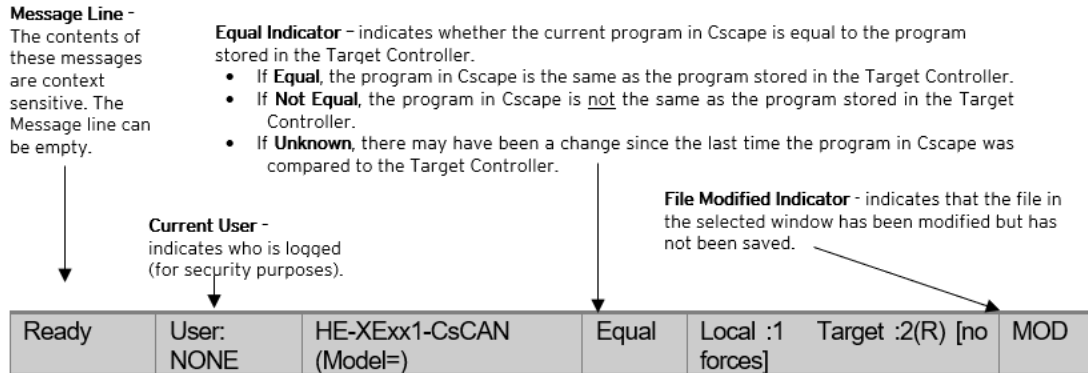

Controller Model - Network (Model Confirmation)

- **Controller Model** indicates the controller model for which the program in Cscape is configured.
- **Network** indicates the type of network that the program in Cscape expects to use (e.g., CsCAN).
- **(Model Confirmation)** provides the following indications:
 - **(Model=)** - The actual Target Controller matches the configured Controller Model and Network.
 - **(Model Not=)** - The actual Target Controller does not match the configured Controller Model and Network.
 - **(Model ?)** - There may have been a change since the last time the Target Controller was compared to the configured Controller Model and Network.

Communications Status - indicates the current status of the "pass through" Connector.

- **Local: xx** - indicates the Network ID of the OCS to which the Cscape program is physically connected through its serial port. It can serve as a pass-through device to other nodes on the network.
- **Target: yy(R)** - indicates the Network ID of the device with which the Cscape program is exchanging data.
NOTE: The **Local** unit and **Target** unit can be the same unit, or they can be separate units.

The following are status indicators:

- (R) - Running
- (D) - Do I/O
- (I) - Idle
- (?) - Cscape is not communicating with the remote unit.
- [no forces] - indicates no I/O has been forced.

Establishing Communications

The XLE/XLT can communicate with Cscape using USB to serial adapters, Ethernet, USB, or CAN (CsCAN).

Communicating via USB Port - To communicate with the XLE or XLT via USB you will need the Automated Driver Installer located on the Horner Automation web site. The drivers may be loaded from the **HE-XEC Ethernet Utility / HTTP Web Server Demo / Communications Drivers** section of the support files page on our website, found here: <https://hornerautomation.com/support-files> .

Next, connect a PC's (Personal Computer running a Windows Microsoft operating system) USB port via USB cable to the USB mini B port on the XLE/XLT OCS.

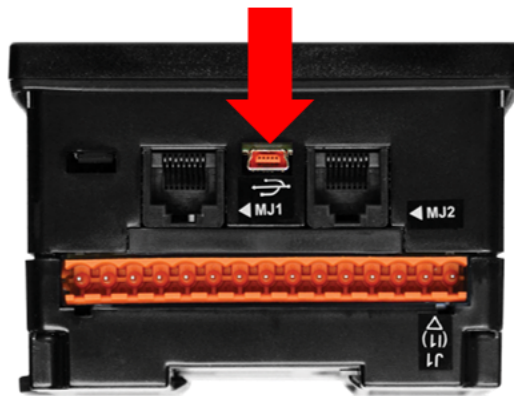

The PC will detect a new device has been plugged into the USB port.

Open Cscape and the first screen to open will be the **Connection Wizard > USB > Next>> > Finish**.

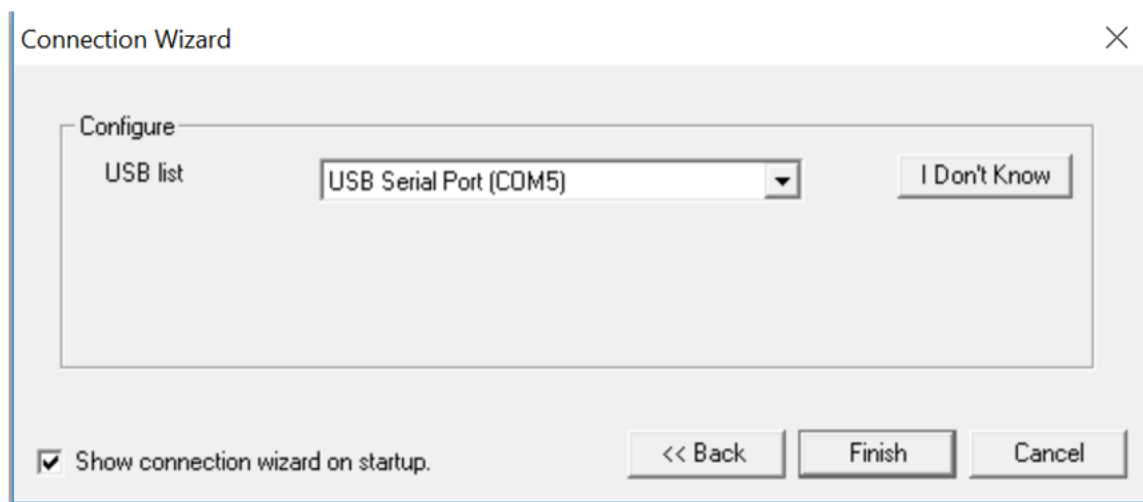

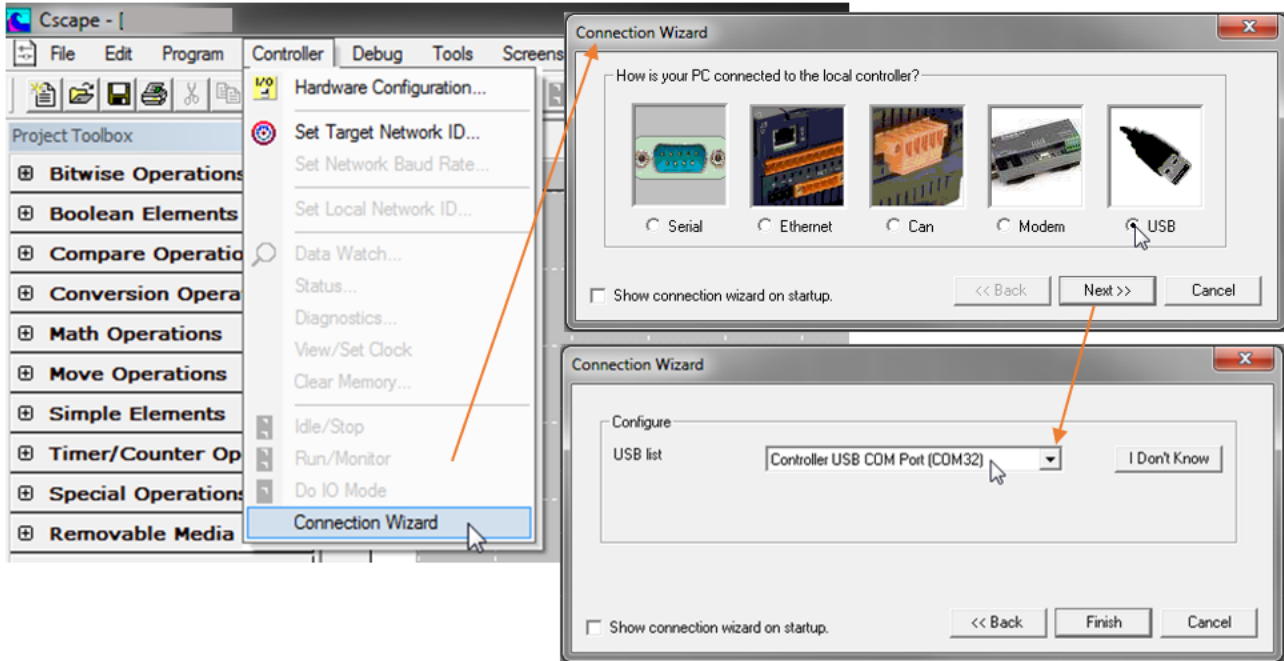

If **Controller USB COM Port** is not present in the dropdown list, the Windows operating system has not yet recognized the OCS as an installed device. Be sure the installation process is complete and that the correct drivers are installed. The Connection Wizard must be completely closed and reopened to refresh the USB dropdown list.

An alternate way to select the COM setting is to go to **Cscape > Tools > Application Settings > Communication > Configure** and choose connection method in **Add Target**.

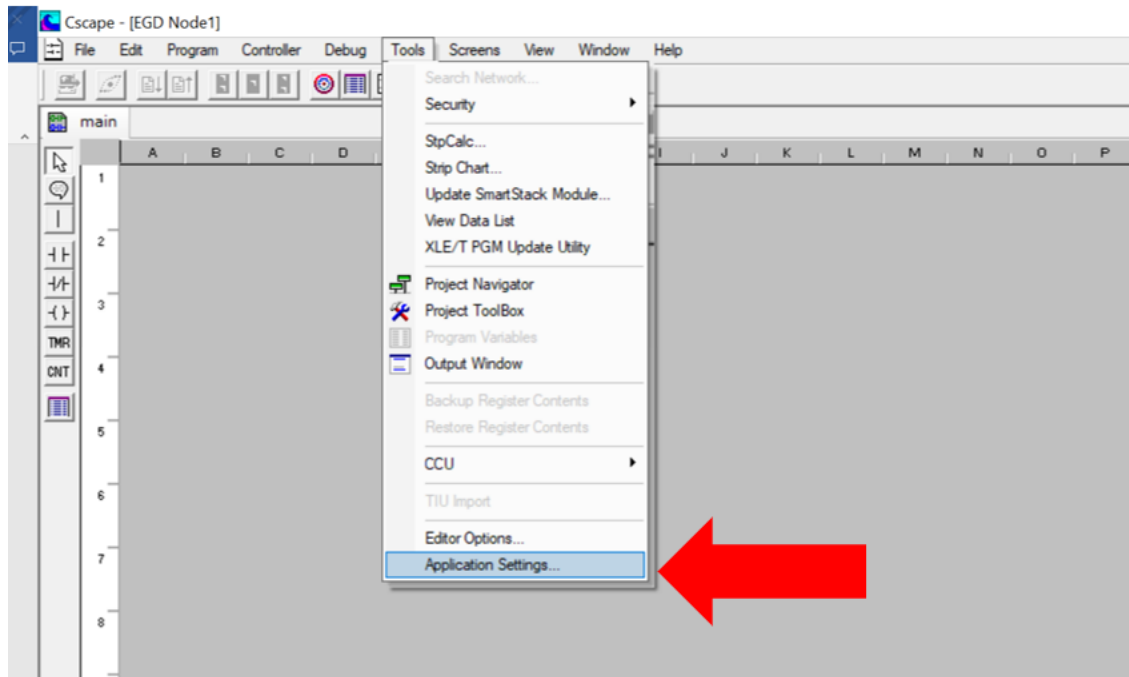

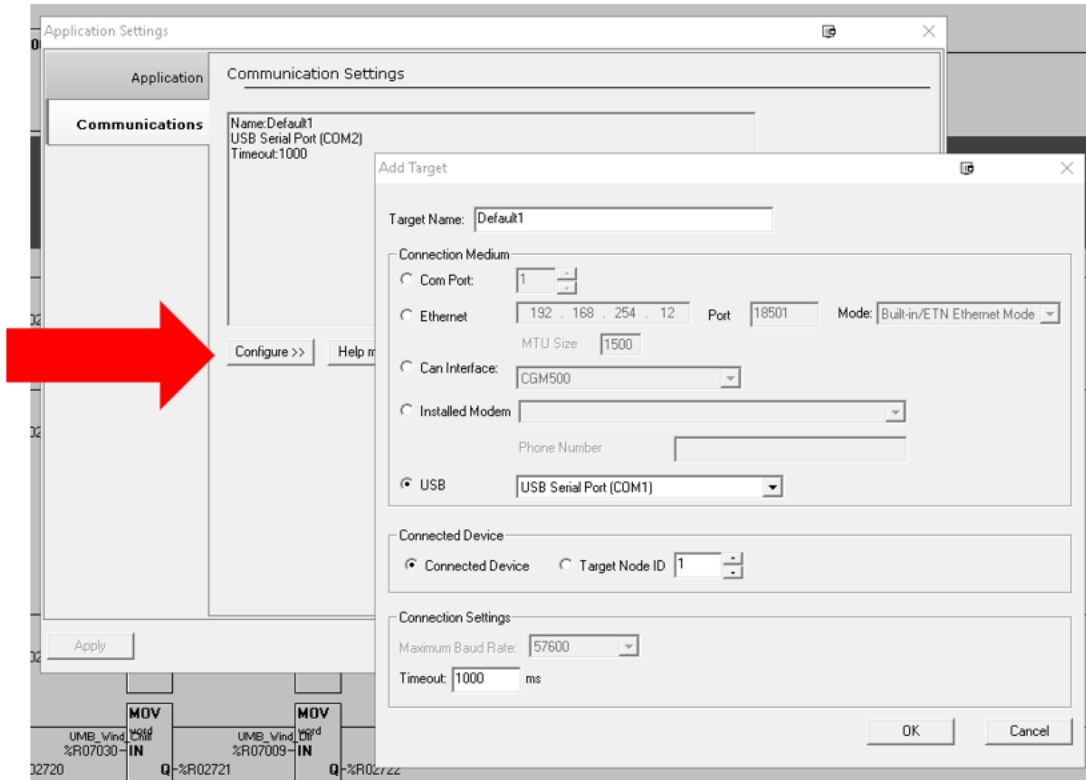

Communication Configuration Dialog	
Target Name	Name for connection. This is not a mandatory column to be filled, by default Cscape will populate 'Default1' in edit box.
Connection Medium	
Com Port	Select this option to communicate over serial communication with the device. The port number can be configured here.
Ethernet	<p>Select this option to communicate over Ethernet. Provide the IP address of the device and select the mode: HE GSM GPRS mode, Built in/ ETN Ethernet mode, or HE XEC Ethernet mode.</p> <p>Select HE GSM GPRS mode if communication with XL series controller on GPRS is required and the device has GSM modem installed in XL series controller. Select Built in/ ETN Ethernet mode if the device has on-board Ethernet port. Select HE XEC Ethernet mode if the device has Ethernet comm. option board installed in XL series controller.</p> <p>NOTE: For GPRS connectivity, GPRS configuration from Programs à Messaging à GPRS needs to be done.</p> <p>NOTE: The controller should support the type of connectivity selected and configured for Ethernet communication.</p>
CAN Interface	Select this option to communicate over CAN. This option requires additional hardware to be installed with the PC to be able to do so. Select the type of hardware installed from the drop-down.
Installed Modem	Select this option to communicate to the device through the internal modem of the computer. Cscape will automatically detect the internal modem attached with PC and list in the attached drop down. User can select modem and telephone number for target controller. NOTE: Cscape will do necessary initialization for the selected internal modem.
USB	Select this option to communicate over USB. Now Horner devices and Horner USB to serial converters are recognized and can be specifically selected.
Connected Device	
NOTE: This configuration is required if the controller to which Cscape is communicating is connected to a CsCAN network.	
Connected Device	By default, this option is selected and networking feature of Cscape is disabled.
Target Node ID	On selecting this option, Networking feature of Cscape is enabled. CsCAN ID for the target controller to be provide here.
Connection Settings (General Communication Settings)	
Maximum Baud Rate	Select the baud rate for serial communication.
Timeout	Select the communication timeout. NOTE: Select a larger timeout for GPRS and installed modem communication configuration

If communications are successful, the message line should show “USB (COM8)” for this example, and an (R) should follow the Target number.

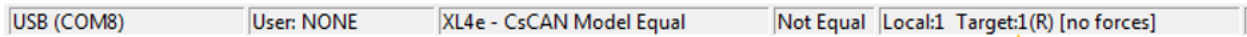

When connected directly to the controller to which Cscape communications are required, the **Local ID and the Target ID should match.**

Local ID and Target ID Match

If the controller is not communicating, you may need to set the target ID of the controller in Cscape or on the unit. The Target ID allows directing communications to a particular unit when multiple units are connected via a CsCAN network. Units without CsCAN network ports respond to any network ID and do not require the ID to be configured.

Communicating via MJ1 Serial Port

If a serial programming connection is to be used and the PC has a 9-pin serial COM port, which is increasingly rare, there is nothing to install assuming the port already works. All that is needed is a programming cable to go from the COM port to the OCS programming port.

If a serial programming connection is to be used and the PC does not have a COM port, a USB-to-Serial adapter may be used. Horner offers the HE500USB600 USB-to-RS232 Serial Adapter, which comes as part of the [HE-CPK](#) programming kit. Drivers for it are normally found automatically by the Windows operating system as long as an internet connection is established. Otherwise, the drivers may be loaded from the Horner FTP site at <https://hornerautomation.com/support-files/>.

Connect the PC's serial port or the USB-to-Serial adaptor to the port labeled MJ1 on the XLE/XLT.

The instructions are similar to using a USB port, as shown above. In the Connection Wizard, select the “Serial” option.

If communications are successful, the target indicator should show the mode of the controller Target: yy(R) as shown above in "Cscape Status Bar" on page 58

If the controller is not communicating, you may need to set the target ID of the controller in Cscape or on the unit. The Target ID allows directing communications to a particular unit when multiple units are connected via a CsCAN network. Units without CsCAN network ports respond to any network ID and do not require the ID to be configured.

To check or change the ID on the XLE/XLT OCS, press the UP and DOWN keys on the XLE/XLT simultaneously to enter the System Menu. The first item in the menu is Set Network ID. Pressing Enter allows you to view or modify the ID of the unit.

To change the Target ID of Cscape use the **Controller > Set Target Network ID** dialog.

Communicating via On Board Ethernet Port

From Cscape go to **Controller > Hardware Configuration** and do auto configuration for the connected controller, Click on Config of Ethernet & go to Module Setup.

The IP address, Net Mask, and Gateway of the controller may be temporarily set from the system menu under the Set Networks menu item. Once running or power cycled the configuration will come from the Cscape configuration stored in the unit.

In Module configuration dialog, go to IP Address field enter unused IP Address and configure unused registers in Register field & then click OK. Screen shot for the same as follows:

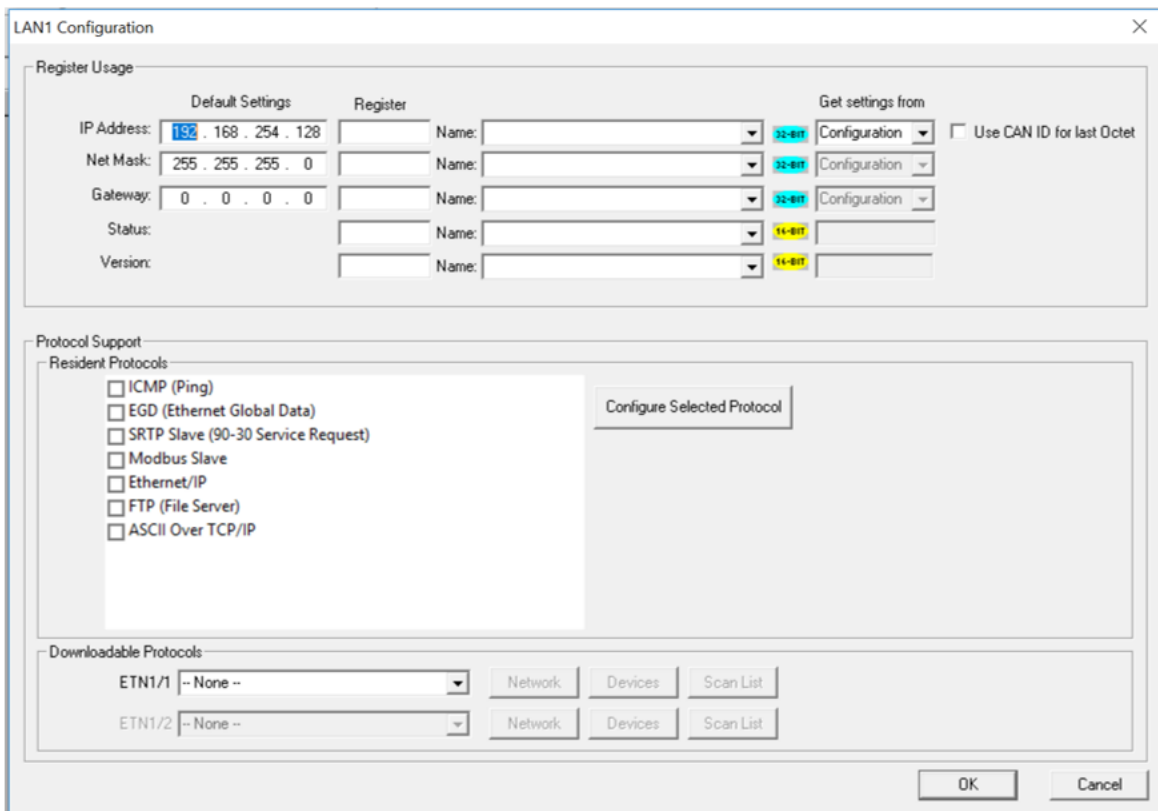

Download the configuration in to Controller. Connect LAN cable to the Controller in default LAN Port. From Cscape go to **Tools > Editor Options > Communication Port > Configure**. Select Ethernet and enter IP address which is configured in the file. Select mode as XL Series mode from drop down list.

The controller should get connected to Cscape. If communications are successful, the target indicator should show the mode of the controller Target: yy(R) as shown in the as shown above in "Cscape Status Bar" on page 58.

Cscape Configuration

For more details refer to the Cscape Help File.

An overview of configuration:

1. Start the configuration by selecting the Controller > Hardware Configure menu item.
2. If the controller is connected to the PC press the Auto Config System button to automatically detect the Base model, I/O and any communication options.
3. If the controller is NOT connected:
 - a. Select **Series > XL Series**
 - b. Select **Device Type > XLE/XLEe or XLT/XLTe**
 - c. Select **Model # >** (See part number building below)

GLOBAL MODEL NUMBERS

	screen	Ethernet	I/O
HE-X	<input type="text"/>	1 <input type="text"/>	<input type="text"/>
	E (no touchscreen) T (touchscreen)	O (no Ethernet) E (Ethernet)	0 (model 0) 2 (model 2) 3 (model 3) 4 (model 4) 5 (model 5) 6 (model 6)

EUROPEAN MODEL NUMBERS

	screen	Ethernet	CAN option	I/O	overlay type
HEX	<input type="text"/>	<input type="text"/>	C <input type="text"/>	<input type="text"/>	- <input type="text"/>
	E22 (no touchscreen) T24 (touchscreen)	0 (no Ethernet) 1 (Ethernet)	0 (no CAN*) 1 (CsCAN) 2 (CANopen) 4 (DeviceNet) 5 (J1939)	00 (model 0) 12 (model 2) 13 (model 3) 14 (model 4) 15 (model 5) 16 (model 6)	00 (dark colour) 01 (light colour) 02 (blank) 03-99 (custom)

*No CAN is only available on XLE

General I/O Configuration



General I/O Configuration

Built-in Digital and Analog I/O Overview	67
Removing the Back Cover	68
Digital / HSC Input Configuration	69
Digital / PWM Output Configuration	73
Analog Inputs	78
Analog Outputs	87

Built-in Digital and Analog I/O Overview

The Horner OCS is a compact unit that contains high density and very versatile I/O. Using the I/O properly requires wiring to the proper terminals, configuring jumpers inside the Horner OCS unit and configuring Cscape properly. This section will offer some tips and suggestions to configure the I/O properly. For the register mapping of the I/O, refer to the "System Register Tables" on page 45 chapter for more details.

Built-in Digital & Analog I/O								
Digital				Analog				
	DC In	DC Out (+)	Relay Out	HSC In*	Pulse Out**	mA/V In	mA/V RTD/TC (Universal)	mA/V Out
Model 2	12	--	6	4	--	4	--	--
Model 3	12	12		4	2	2	--	--
Model 4	24	16	--	4	2	2	--	--
Model 5	12	12	--	4	2	2		2
Model 6	12	12	--	4	2	--	6	4

*Shared with total DC inputs

**Shared with total DC outputs

For more details, see the controller datasheets via [Document Search](#).

Removing the Back Cover

WARNING: Power, including I/O power must be removed from the unit prior to removing the back cover. Failure to do so could result in electrocution and/or damage to equipment.

Some I/O configurations require jumper settings to be changed inside the Horner OCS unit. Examples of these settings are setting positive or negative logic on digital inputs or setting current or voltage on analog inputs.

Each Horner OCS I/O jumper is set to a factory default. Refer to the datasheet for a specific Horner OCS model to find the default setting to determine if a jumper change is necessary. Refer to Horner's [Documentation Search](#) page.

To remove the back cover of the Horner OCS, remove the four (4) Phillips screws from the back of the unit. It may help to place the Horner OCS unit face down on a clean work surface. Once the four screws are removed the back cover can be lifted straight off.

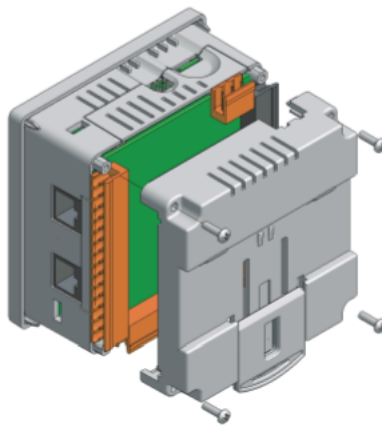

Once the back is removed the jumper selection can be changed. The jumper settings are documented on each data sheet using a diagram such as the figure below and a description of the jumper settings.

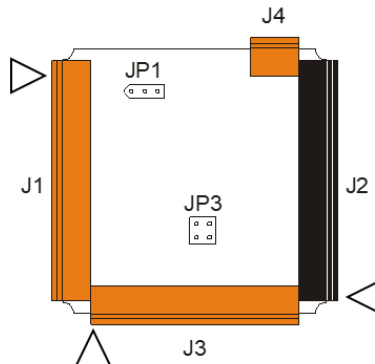

To re-install the back cover, place the cover back on the unit. The DIN clip should be on the same side as the power connector.

Place the screw back into the hole and turn the screw slowly counter clockwise until it clicks into the threads. This prevents the screw from being cross-threaded. Now turn the screw clock-wise until the cover is firmly secured. Repeat this process for all four (4) screws. Recommended torque is 3 - 4 in-lbs (0.34 – 0.45 Nm).

Digital / HSC Input Configuration

Horner controllers vary greatly on series and model numbers. Refer to the datasheets on the [Document Search](#) table on the Horner website.

The inputs are designed to support both positive and negative input modes. For many models, the mode is set by a jumper setting and a configuration parameter in Cscape. The Model 6 does not require jumpers, and only requires a configuration parameter in Cscape. All the inputs on the unit must be configured to the same mode.

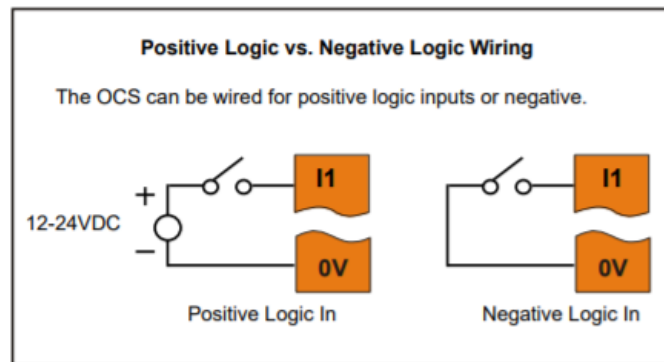

In positive logic mode a positive voltage applied to the input will turn the input. The internal design of this mode is basically a resistor from the input to I/O ground. This mode is sometimes called sourcing.

In negative logic mode, connecting the input to the I/O ground or zero volts will turn the input on. The internal design of this mode is basically a resistor from the input to the positive I/O voltage (usually 12 or 24V). This mode is sometimes called sinking.

Some of the digital inputs may support high-speed input functional such as counting or frequency measurement.

Digital Input Configuration

Home > Hardware Configuration [select Device Type/Model#] > Local I/O Tab > I/O / Config Button > Module Setup > Digital In/HSC

Select Hardware Configuration from the Home menu and ensure that the correct Device Type and Model# are selected. Then select the **Local I/O** tab.

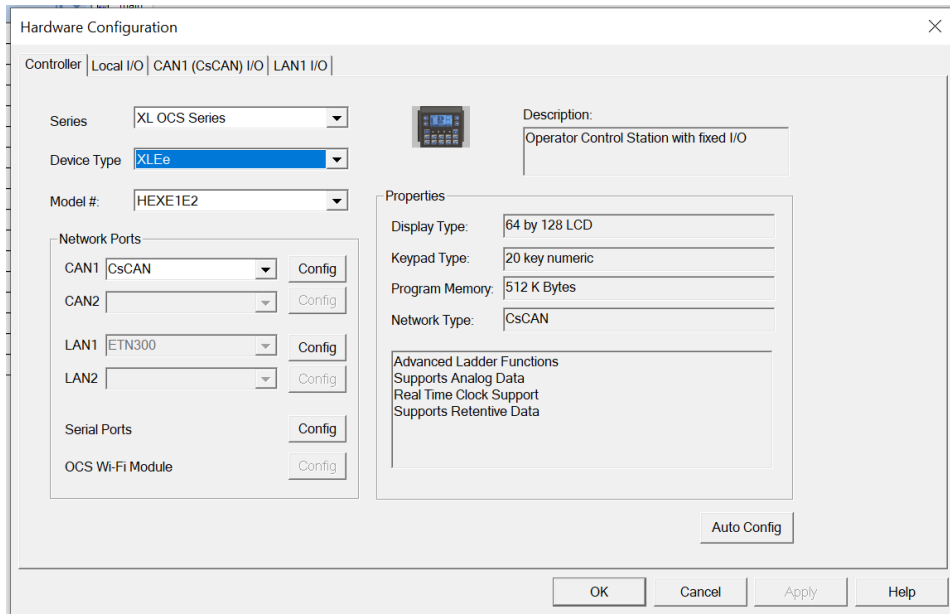

After selecting Local I/O, select the **Config** button next to the I/O connector.

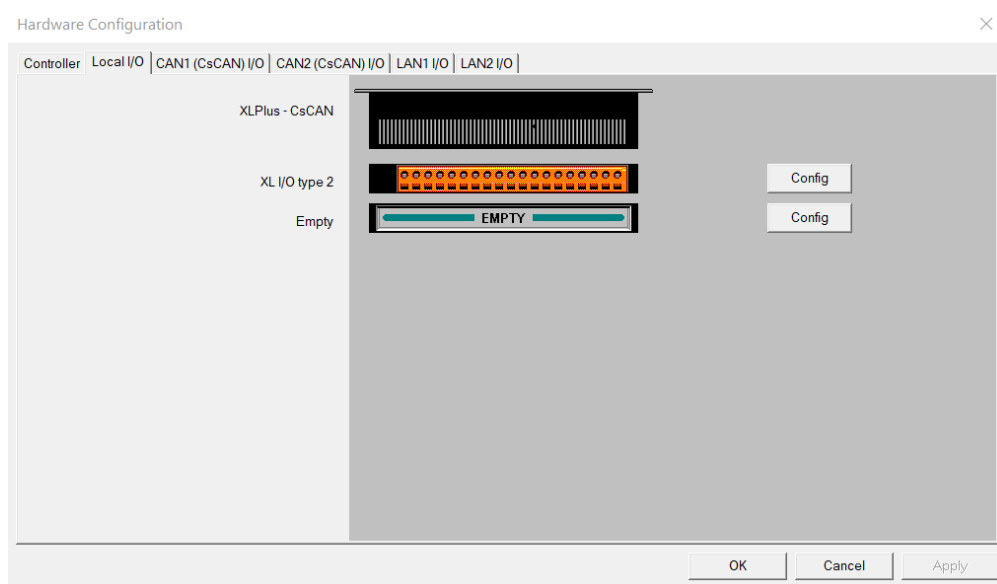

The **Module Configuration** screen will appear, select the **Module Setup** tab. See below.

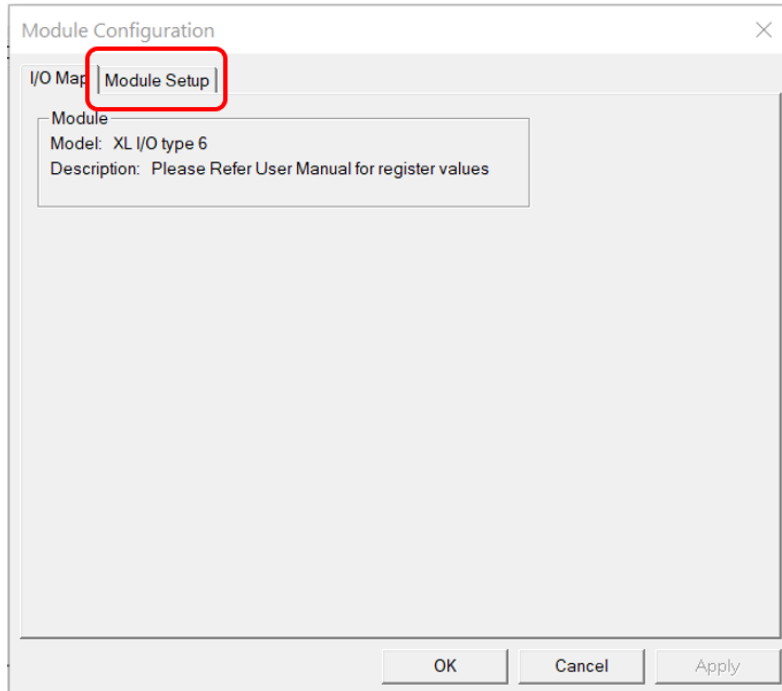

The Module Setup allows a user to configure four types of I/O. **NOTE:** Not all controllers offer all four types. Refer to the controller's datasheet on the using Horner's [Documentation Search](#) page.

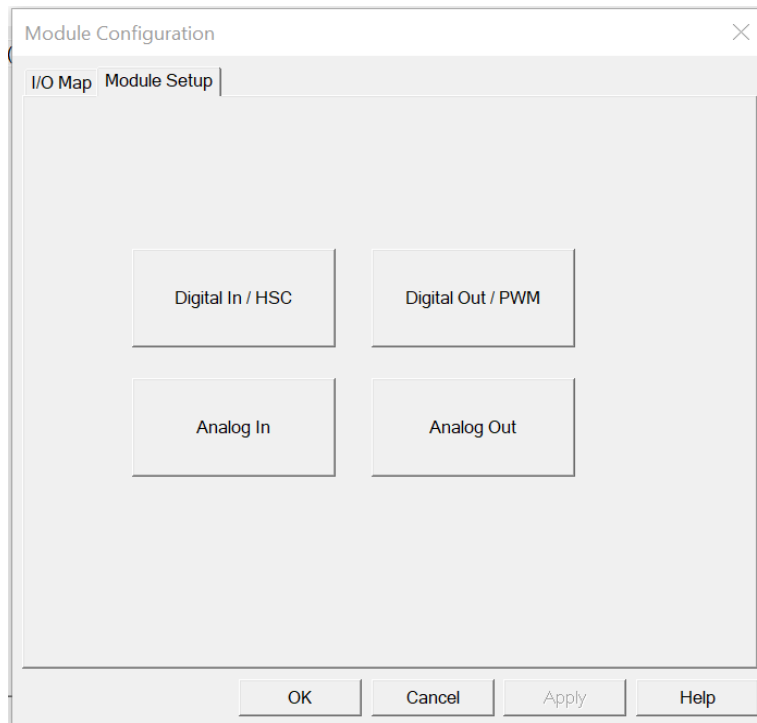

Select **Digital In/HSC** to open the Digital / HSC Input configuration dialog for a specific controller.

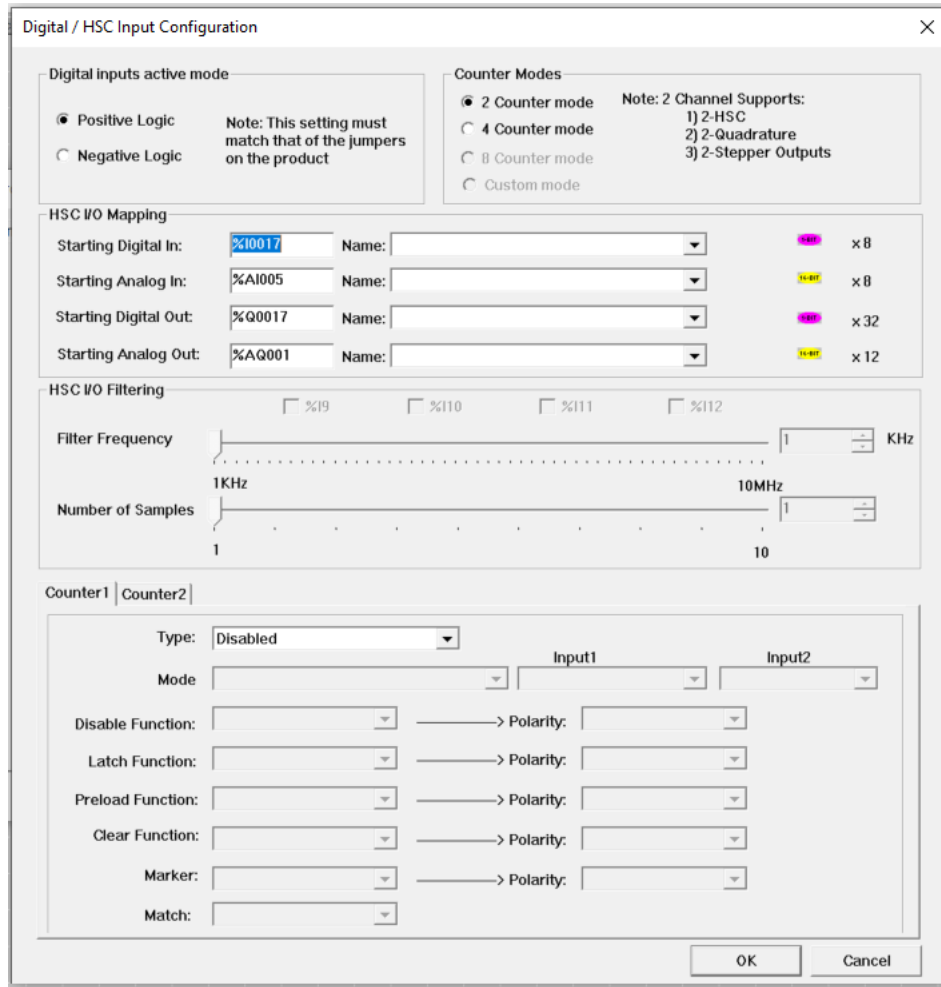

The Active mode group box allows the user to select if inputs are active high (Positive logic) or active low (Negative logic). It is important that this setting matches the jumper settings on the hardware.

The High-Speed Counters group box contains all the windows that are used to configure the four available high-speed counters on the Horner OCS. To configure a counter, the user needs to set the type, mode, and counts per rev.

The type drop down includes the following options:

- Disabled
- Frequency
- Totalize
- Pulse
- Quadrature
- Marker (Only available in counter #3 if counter #1 is set to quadrature.)

The mode drop-down items are set according to the type selection. The Counts Per Rev. window is enabled/disabled according to the type selection as well.

Digital / PWM Output Configuration

Solid State Digital Outputs

Solid-state digital outputs are generally used to activate lamps, low voltage solenoids, relays, and other low voltage and low current devices.

NOTE: The digital outputs used on some controllers are sourcing outputs. This means the output applies a positive voltage to the output pin when turned ON. When turned off, the output applies approximately zero volts with respect to the I/O ground. Use the Documentation Page to view the datasheet for a specific controller for specifics on a module's I/O.

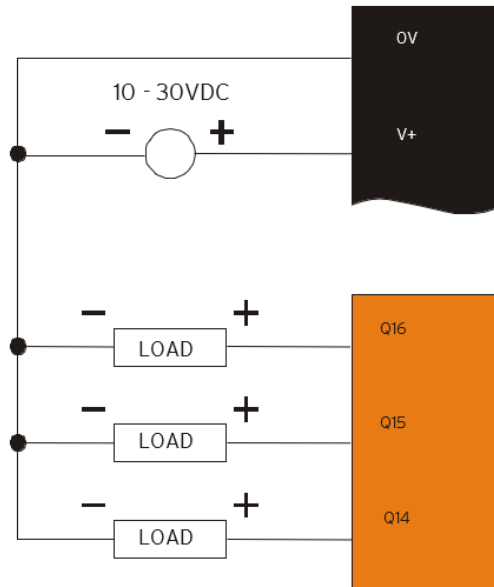

The digital outputs used in the OCS have electronic short circuit protection and current limiting. While these electronic protections work in most applications, some application may require external fusing on these outputs.

The digital outputs in the OCS are typically controlled via %Q bits in the register mapping. Some of the outputs are designed for high-speed applications and can be used for PWM or frequency output applications.

When the controller is stopped, the operation of each output is configurable. The outputs can hold the state they were in before the controller stopped or they can go to a predetermined state. By default, digital outputs turn off.

NOTE: The digital outputs feature an output fault bit. %I32 will turn on if any of the outputs experience a short circuit, over-current or the output driver overheats.

Relay Outputs

Relay outputs are designed to switch loads that typically have high voltage or current requirements or require the isolation that relays provide. Relay outputs are not available on all controllers, see the datasheet. **NOTE:** The design of the OCS does not require external coil power for the relays to function. The relays will activate anytime the OCS is powered. There are several factors that should be considered when using relays:

- **Relay Life** – Relays are mechanical devices that have a long but limited life. Typically, switching more current limits the life of relays. Please check the data sheets at the end of this manual for expected relay life.
- **Current / Temperature De-Rating** – Products containing relays often have total current limits based on the ambient temperature of the application. Please see the product data sheet for current / temperature de-rating information for relays.
- **Fusing** – External fusing is generally required to protect the relays, devices and wiring from shorts or overloads.

WARNING: To protect the module and associated wiring from load faults, use external (5A) fuse(s) as shown. Fuses of lower current or fusing for the entire system need to be in place to assure the maximum current rating of the unit is not exceeded.

WARNING: Connecting high voltage to any I/O pin can cause high voltage to appear at other I/O pins.

Below is an example of Relay Fusing:

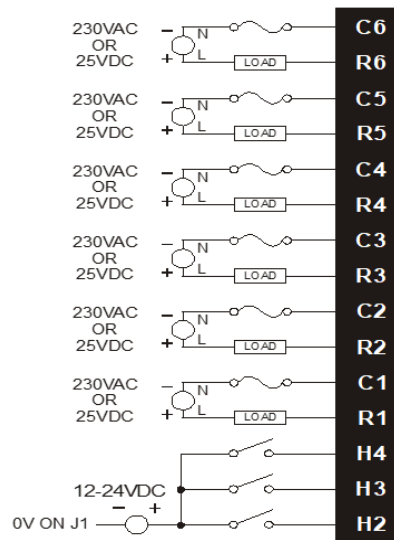

Protection for Inductive Loads - Inductive loads can cause reverse currents when they shut off that can shorten the life of relay contacts. Some protective measures need to be determined by an engineer. Below you will find recommendations that will work for many applications. If you have additional questions on protection from inductive load, consult an application engineer or Horner Technical Support. Details on devices that may protect outputs can be found in the [Spark Quencher Datasheet](#), MAN0962, which is located on the website.

Output State on Controller Stop - When the controller is stopped, the operation of each output is configurable. The outputs can hold the state they were in before the controller stopped or they can go to a predetermined state. By default, relay outputs turn off.

Digital Output Configuration

Home > Hardware Configuration [select Device Type/Model#] > Local I/O Tab > I/O / Config Button > Module Setup > Digital Out/PWM

Select Hardware Configuration from the Home menu and ensure that the correct Device Type and Model# are selected. Then select the **Local I/O** tab.

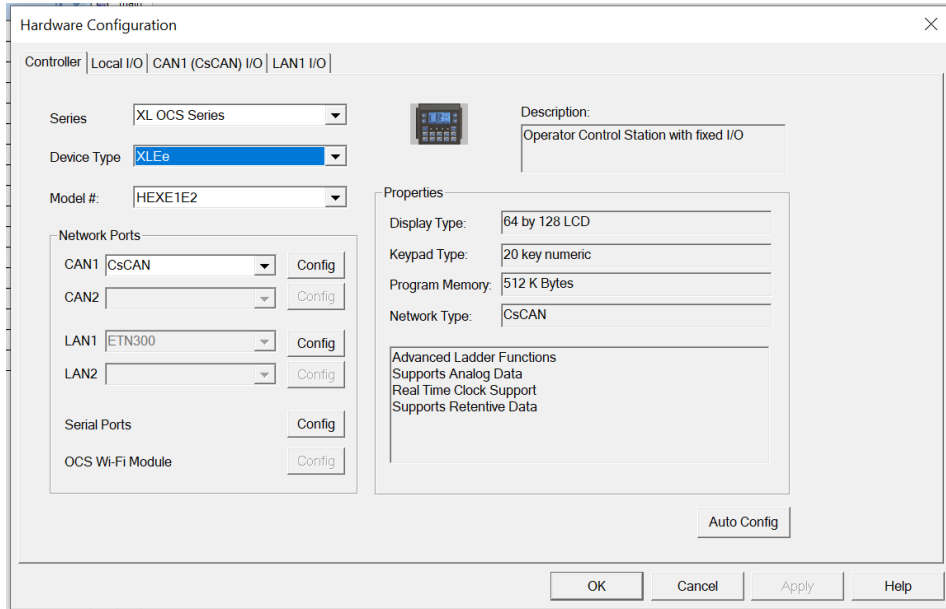

After selecting Local I/O, select the **Config** button next to the I/O connector.

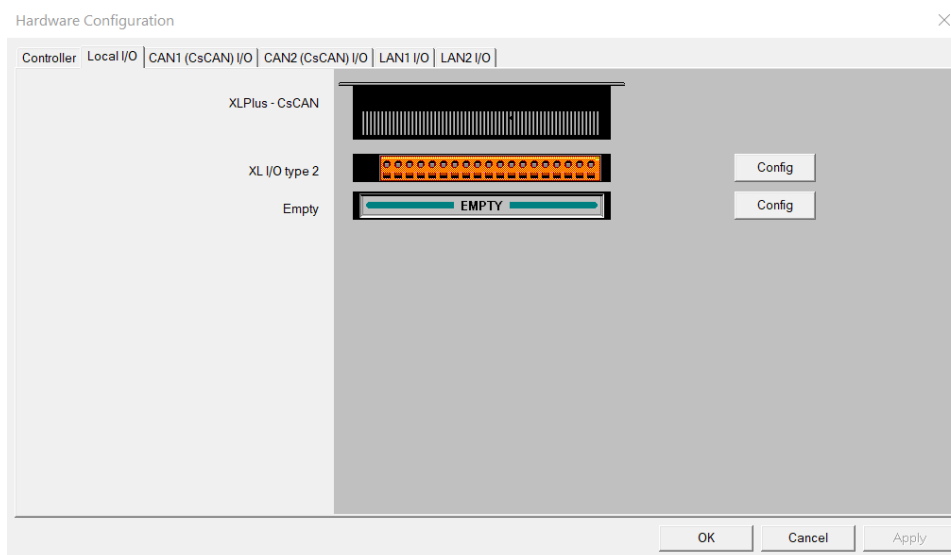

The **Module Configuration** screen will appear, select the **Module Setup** tab. See below.

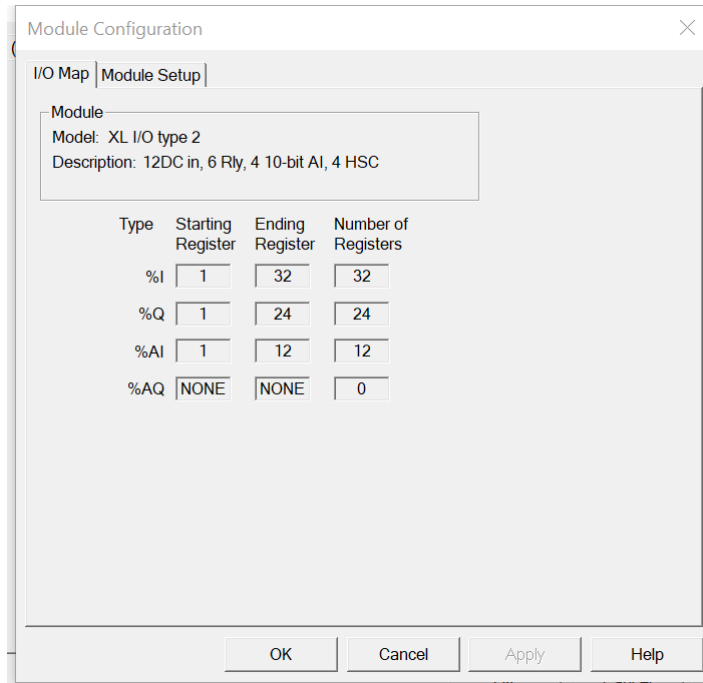

The Module Setup allows a user to configure four types of I/O. **NOTE:** Not all controllers offer all four types. Refer to the controller's datasheet the using Horner's [Documentation Search](#) page.

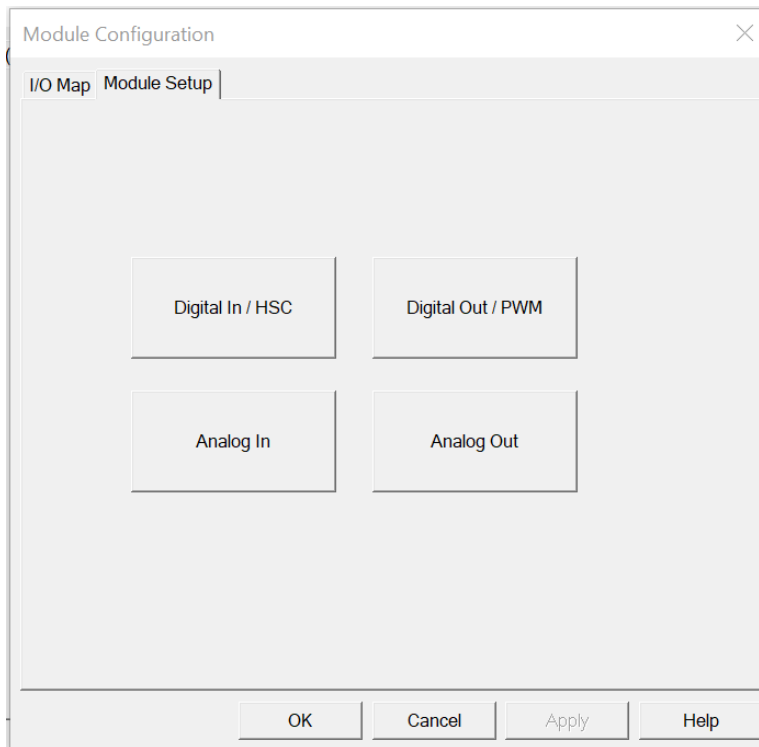

Select **Digital Out/PWM** to open the **Digital / PWM Output Configuration** dialogue.

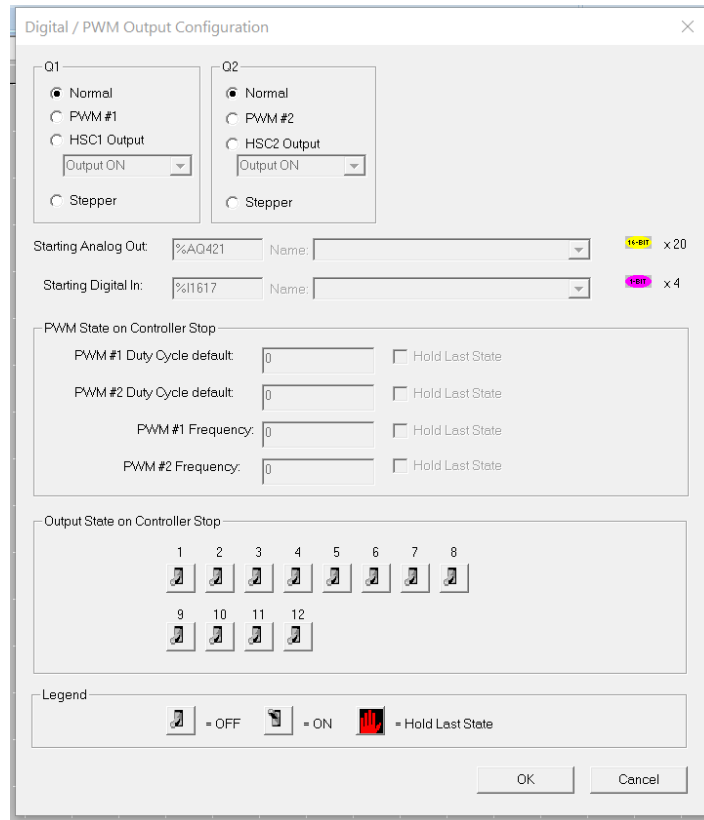

The **Q1** and **Q2** group boxes allow the user to specify the operation of the multifunction outputs.

PWM State On Controller Stop - Contains items that allow the user to specify how the PWM outputs behave when the controller is stopped. These items can either hold their value or default to some value when the controller is stopped.

NOTE: The PWM outputs are set to the OFF state at power-up and during program download and remain in that state until the unit is placed in RUN.

Output State On Controller Stop - Contains items to allow the user to specify how the remaining digital outputs behave when the controller is stopped. These items can either hold their value or default to some value when the controller is stopped. **NOTE:** The number of Output States on Controller Stop vary by product.

Stop State - When a controller stops running ladder logic, the state of most output I/O modules can be configured. By default digital outputs turn OFF and analog outputs go to a zero output level. Outputs can be configured to hold the last state the outputs was in when the controller stopped, or it can be configured to go to a predefined state.

NOTE: When a controller is in DO I/O mode the outputs are still controlled by the values in the controller's registers.

NOTE: The number of Output State on Controller Stop varies by controller. See the datasheet on the Documentation Page for more details.

Analog Inputs

The analog inputs on the OCS allow voltage or current measurement from a variety of devices. The voltage or current mode is set through jumpers on the unit and settings in Cscope. Each channel can be separately configured for voltage or current mode.

The analog inputs have a digital filter that can be used to filter electrical noise that may be unavoidable in some installations. The downside to digital filtering is the inputs will respond more slowly to sudden changes in the actual input.

Home > Hardware Configuration [select Device Type/Model#] > Local I/O Tab > I/O / Config Button > Module Setup > Analog In

Select Hardware Configuration from the Home menu and ensure that the correct Device Type and Model# are selected. Then select the **Local I/O** tab.

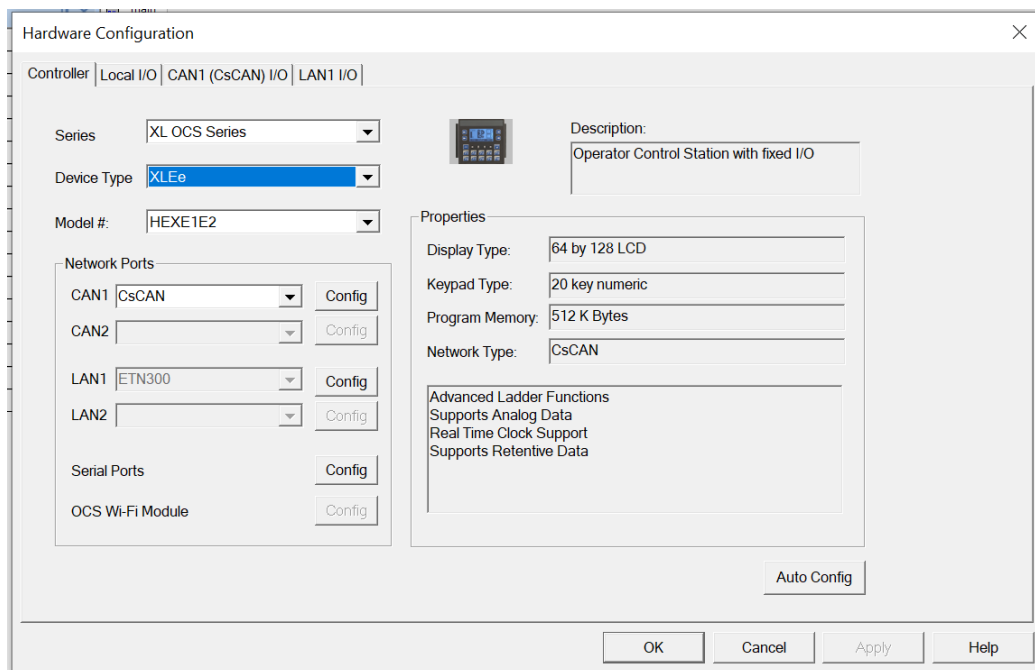

After selecting Local I/O, select the **Config** button next to the I/O connector.

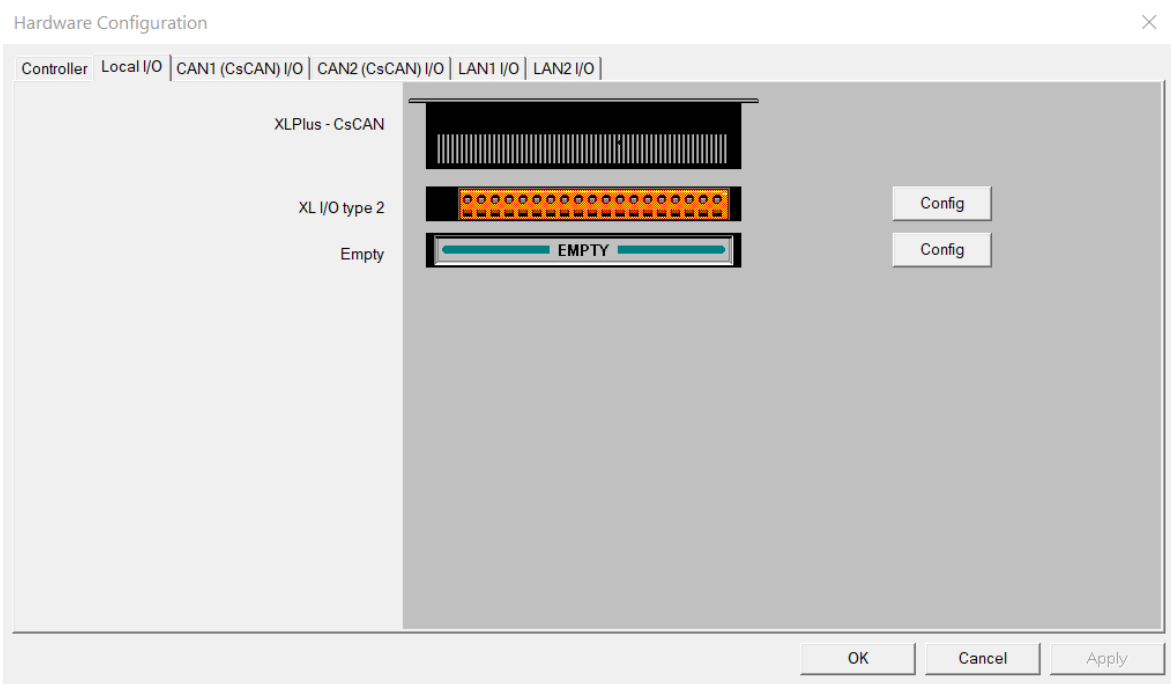

The **Module Configuration** screen will appear, select the **Module Setup** tab. See below.

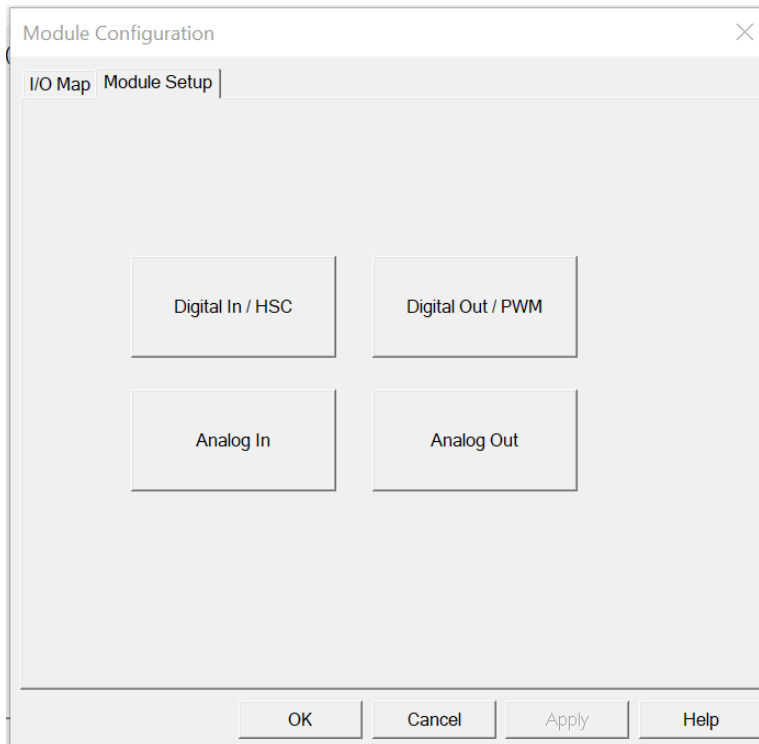

The Module Setup allows a user to configure four types of I/O. **NOTE:** Not all controllers offer all four types. Refer to the controller's datasheet on the Horner website's [Documentation Page](#) for more information regarding specific models.

Select **Analog In** to open the **Analog Input Configuration** dialogue:

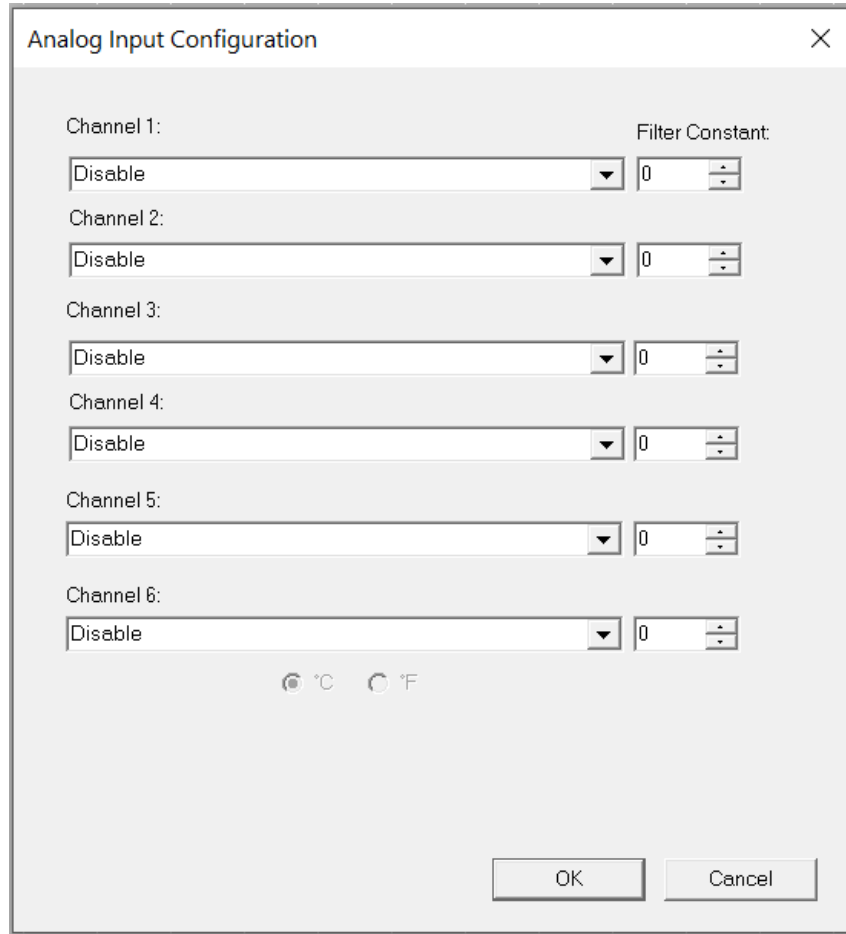

The dialog box, titled "Analog Input Configuration", contains six rows for Channel 1 through Channel 6. Each row has a dropdown menu set to "Disable" and a "Filter Constant" field set to "0". At the bottom, there are radio buttons for temperature units: "°C" (selected) and "°F". "OK" and "Cancel" buttons are at the bottom right.

The Channel x drop down windows allow the user to specify the mode for each analog input to operate. The Channel x drop down windows are enabled/disabled according to which model is being configured. All of the models have the following modes available:

- 0..10V
- 0..20mA
- 4..20mA

On the XL series, the Model 5 and Model 6 modules have more channel options.

Universal Analog Inputs Model 5

The universal analog inputs provide a high resolution, very flexible interface for a variety of analog inputs. These inputs include voltage, current, thermocouple, RTD, and millivolt. Each channel can be configured separately using jumpers and configuration settings in Cscope.

Like the standard analog inputs, these inputs have a digital filter that can be used to filter electrical noise that may be unavoidable in some installations. The downside to digital filtering is the inputs will respond more slowly to sudden changes in the actual input.

Analog In for Model 5
Channels 1 & 2
0..10V
0..20mA
4..20mA
100mV
PT100 DIN RTD, 1/20°C
Type J Thermocouple, 1/20°C
Type K Thermocouple, 1/20°C
Type N Thermocouple, 1/20°C
Type T Thermocouple, 1/20°C
Type E Thermocouple, 1/20°C
Type R Thermocouple, 1/20°C
Type S Thermocouple, 1/20°C
Type B Thermocouple, 1/20°C
* The Filter Constant provides filtering to all channels.

Model 5 Universal Analog Input Configuration

1. Select Analog In to access the Analog Input Configuration menu.
2. Select any of the Analog input types from the drop-downs by clicking the down arrow beneath each corresponding Channel, as seen below:

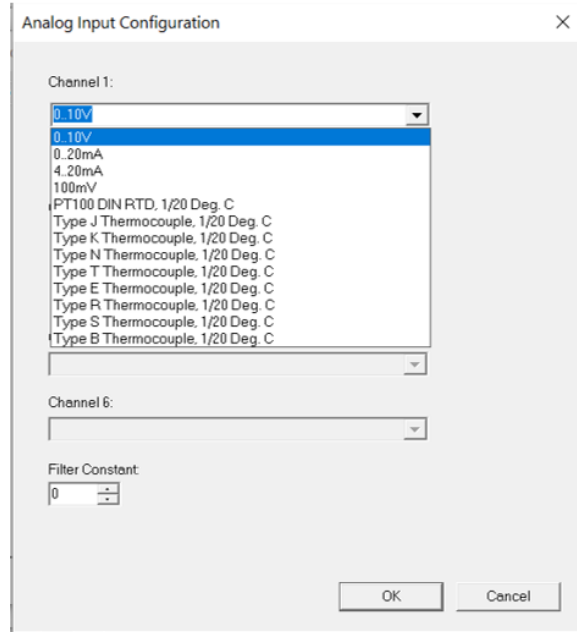

3. Ensure the proper wiring is used for each of the pins on the Universal Analog Inputs as seen in the image and table below:

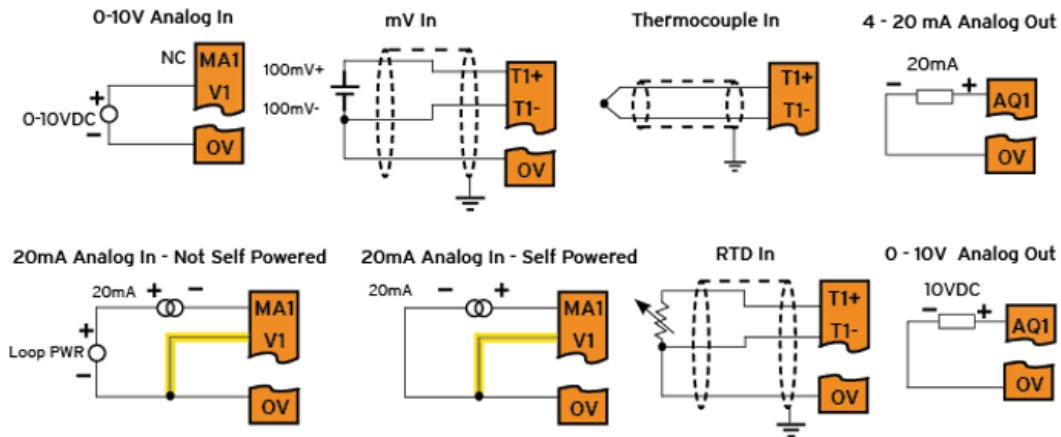

Table for Model 5 Universal Wiring

J3 Connector for Universal Wiring	
T1+	TC (1+) or RTD (1+) or 100mV (1+)
T1-	TC (1-) or RTD (1-) or 100mV (1-)
T2+	TC (2+) or RTD (2+) or 100mV (2+)
T2-	TC (2-) or RTD (2-) or 100mV (2-)
AQ1	10V or 20mA OUT (1)
AQ2	10V or 20mA OUT (2)
0V	Common
MA1	0-20mA IN (1)
V1	0-10V IN (1)
0V	Common
MA2	0-20mA IN (2)
V2	0-10V IN (2)
0V	Common

Universal Analog Inputs Model 6

The Universal Analog Inputs on the Model 6 IO board are unique from other Horner XL-series input/output cards in that they are configurable through the module configuration instead of having to change jumper settings in order to setup the input type.

Analog In for Model 6
Channels 1-6
0..10V
0..20mA
4..20mA
Disable
0-60mV
PT100 DIN RTD, 1/10°C
PT1000 DIN RTD, 1/10°C
Type J Thermocouple, 1/10°C
Type K Thermocouple, 1/10°C
Type N Thermocouple, 1/10°C
Type T Thermocouple, 1/10°C
Type E Thermocouple, 1/10°C
Type R Thermocouple, 1/10°C
Type S Thermocouple, 1/10°C
Type B Thermocouple, 1/10°C

Model 6 Universal Analog Input Type Configuration

1. Select Analog In to access the Analog Input Configuration menu.
2. Select any of the Analog input types from the drop-downs by clicking the down arrow beneath each corresponding Channel, as seen below:

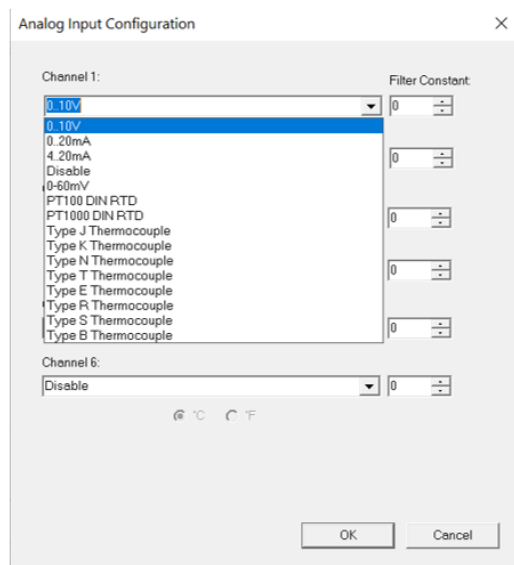

- Ensure the proper wiring is used for each of the 3 pins A , B, and C on the Universal Analog Inputs as seen in the reference image below:

EX: Universal Input Wiring Schematic

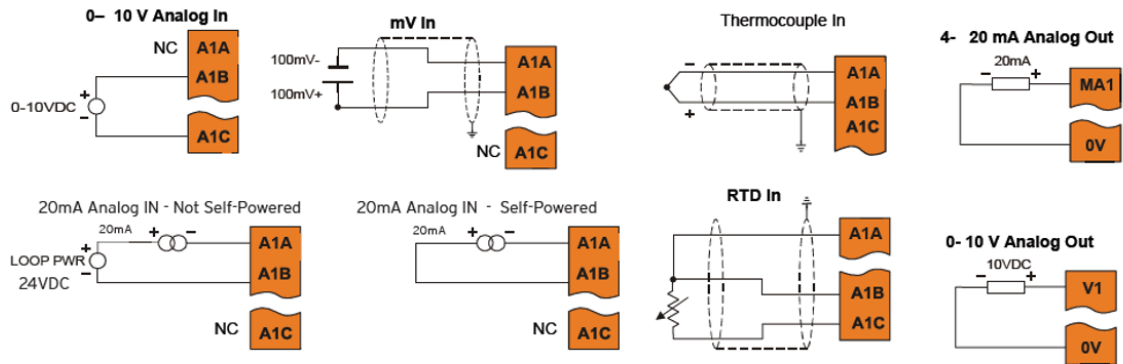

NOTE: Depending on the transmitter, isolated loop power may be required.

Scaling Analog Inputs & Examples

To access the Advanced Math Scaling function, select **Home > View > Project Toolbox**. This will open a side bar, and then select **Advanced Math > Scale**.

Example 1

The Cscape Scale function, found in the Advanced Math functions, allows for very easy conversion of the raw input value into a meaningful reading. For example, a pressure transducer may be specified as a 4-20mA signal to signify a 0-2000 psi pressure reading. With the analog channel set to the 4..20mA range, the raw analog input value, which is in INT format ranges from 0 to 4mA to 32000 for 20mA. Use the Scale function to obtain an Integer pressure reading using the 0-32000 raw input range and the sensor's 0-2000psi output range.

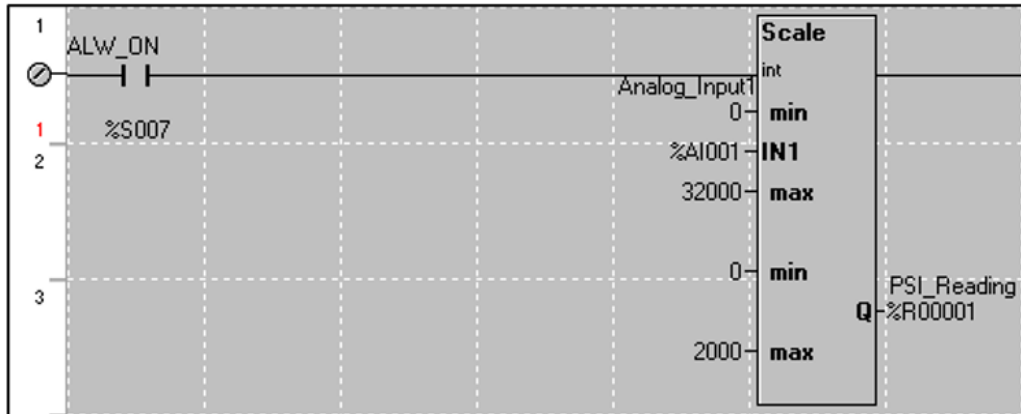

Example 2:

If readings with fractions are required, the raw Integer input value must first be translated in REAL, or Floating Point Format, see note below. . The Cscape INT-to-REAL Conversion function may be used to convert the raw input value from INT to REAL format in an intermediate memory location. The SCALE function, specified as REAL type, may be used to scale the converted raw value into a reading that supports digits beyond the decimal place, i.e. 475.25psi.

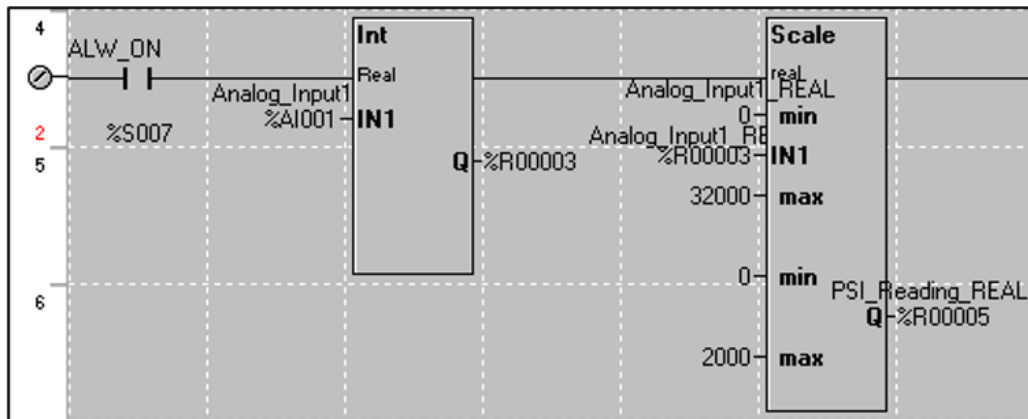

Analog Outputs

NOTE: Refer to the datasheet for details on jumper settings.

The analog outputs on Horner OCS devices provide high resolution voltage or current outputs. The voltage or current selection is controlled with jumpers and configuration settings in Cscape.

NOTE: Each channel can be separately configured for voltage or current mode.

When the controller is stopped, the operation of each output is configurable. The outputs can hold the state they were in before the controller stopped or they can go to a predetermined value. By default, analog outputs are set to a value of zero (0).

The following figure illustrates the Analog Output Configuration dialog. To open the I/O configuration dialogs, select **Controller > Hardware Configuration > Local I/O > Config > Module Setup**.

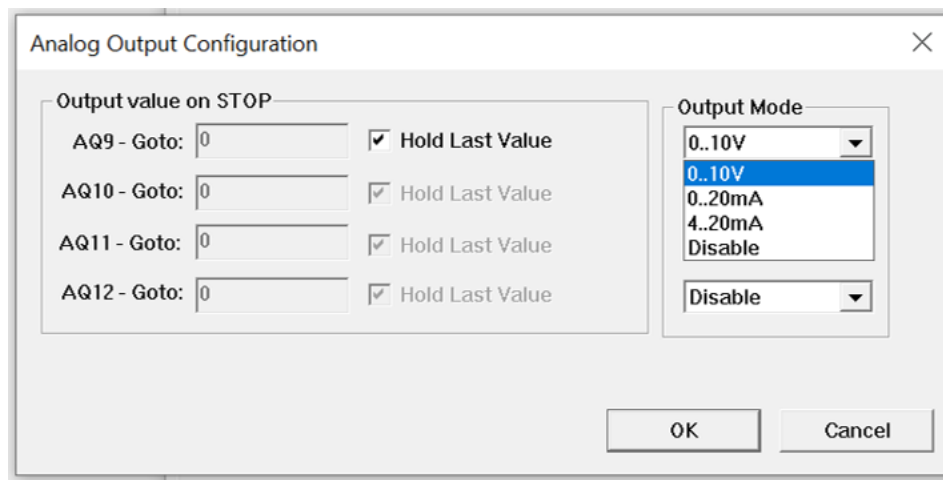

The Output value on Stop group box contains items that allow the user to specify how the analog output channels behave when the controller is stopped. The outputs can either hold their value or default to a value when the controller is stopped.

The Output Mode group box allows the user to select the operating modes for each of the analog outputs. The modes include the following:

- 0..10V
- 0..20mA
- 4..20mA

For more information on Stop State, refer to the "Cscape Configuration" on page 57.

High Speed I/O (HSC & PWM)



High Speed I/O

High Speed Counter (HSC) Functions	89
Frequency	89
Totalize	90
Pulse	91
Period Measurement	91
Quadrature	92
HSC Register Map for XLE & XLT	94
Pulse Width Modulation (PWM) Functions	95
HSC Output	99

Overview XLE & XLT

In addition to the compliment of simple analog and digital I/O, several of the XLE/XLT I/O modules support High Speed Counting (HSC) I/O functions and may also support Pulse Width Modulation (PWM) Output functions.

The HSC functions include frequency, totalizing, pulse width, and quadrature measurement. The PWM functions include traditional PWM (with variable rate and duty) and a stepper (limited functionality) with variable acceleration and deceleration rates.

High Speed Counter (HSC) Functions

On units that support the HSC, four dedicated inputs are available than can be configured for one of four modes of operation. Those modes are Frequency, Count (totalize), Pulse width and Quadrature measurement. For some modes, more than one HSC input may be consumed. The measurement value is provided to ladder in a %AI register. Refer to the "HSC Register Map for XLE & XLT " on page 94.

NOTE: While the high-speed input circuitry has a resolution of 1 μ s, measured edge transitions must not occur faster than 100 μ s for accurate measurements. Keep in mind that pulse width measurements utilize both the rising and falling edges of the waveform, thus the pulse width must exist longer than 100 μ s.

NOTE: The edge polarity selection in the mode parameter for the totalize and pulse width functions (Digital/HSC Input Configuration) assume Positive Logic regardless of the associated I/O board's jumper setting for the Digital DC inputs polarity. If Negative logic is configured when using these functions, the opposite edge polarity must be selected in the mode parameter.

Frequency

In frequency mode, the frequency of the input signal is written to the accumulator in terms of Hertz (cycles/second). When using frequency mode, four update selections are provided which specify the width of the sample window.

NOTE: Selecting a shorter sample window provides a quicker measurement (faster response) but lowers the frequency accuracy (resolution) and increases the minimum frequency measurement limit.

Totalize

In totalize mode, the accumulator is simply incremented each time the input transitions in a specific direction. Totalize mode is configurable to specify the edge (rising or falling) on which the accumulator is incremented.

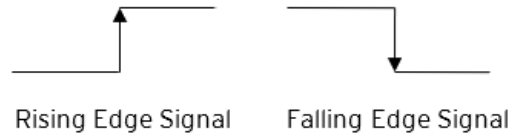

Three different options are available to reset the current count:

- **Configured reset value** - When configuring the Totalize function, a value may be specified under the Counts per Rev column. When the totalizer accumulator reaches this value - 1, the accumulator will reset to zero on the next count. Specifying zero for this value allows the totalizer to count through the full 32-bit range before resetting.
- **Ladder control** - Setting registers %Q17-20 reset HSC1-4 (respectively) with no additional configuration. When these registers are asserted, the associated totalizer accumulator is reset and held at zero (level sensitive).
- **Direct digital input control (HSC1 and HSC2 only)** - HSC3 (%I11) and HSC4 (%I12) may be configured as hardware digital reset signals for HSC1 and HSC2 (respectively). To enable these inputs as reset signals, specify the type as Totalize Reset (NOTE: The corresponding Totalize HSC must be previously configured before this option is available). The direct digital reset controls are edge sensitive with the edge polarity configurable.

Maximum direct digital reset latency is 100µs.

The totalize function also supports an option which compares the current accumulator value with a supplied Preset Value (PV), which is provided through a %AQ, and drives a physical digital output based on the that comparison.

- This option (available for HSC1 and HSC2 only) drives Q1 or Q2 output point (respectively) once the associated totalizer accumulator reaches (or exceeds) the PV value. To enable this function, the corresponding PWM function output (Q1 or Q2) must be configured for HSCx Output.

NOTE: Q1 and Q2 are PWM function outputs that may be configured independently as one of the following: standard digital output, PWM, HSCx or stepper output.

Preset values may be modified during run-time. A preset value of zero disables (resets) the totalizer compares function output causing the output to remain low.

Pulse

In pulse mode, the high-speed input can measure the width or period of a pulse stream in one of four modes and provides a continuous indication of the last sampled value.

Width High 1 μ s Counts – In this sub-mode the accumulator value will contain the number of 1 μ s counts the pulse is high.

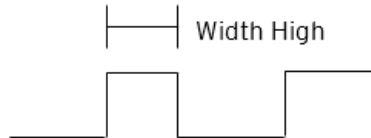

Width Low 1 μ s Counts - In this sub-mode the accumulator value will contain the number of 1 μ s counts the pulse is low.

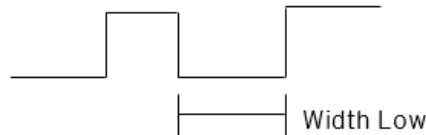

Period Measurement

In period measurement mode, the high-speed input can measure the period of a pulse stream in one of two modes and provides a continuous indication of the last sampled value. In this mode the Disable and Latch special functions are allowed.

Period Rising Edges 1 μ s Counts – In this sub-mode the period of the input signal is reported in one (1) μ s units. The period measurement will start on the rising edge of the input.

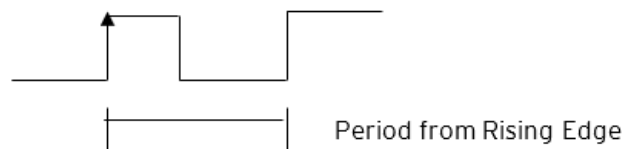

Period Falling Edges 1 μ s Counts – In this sub-mode the period of the input signal is reported in one (1) μ s units. The period measurement will start on the falling edge of the input.

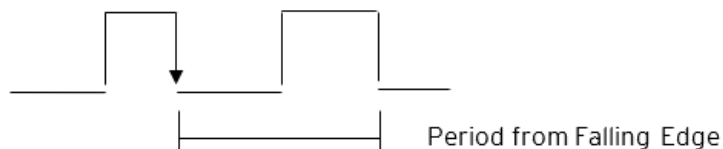

Quadrature

Two HSC inputs are consumed for each of the two possible Quadrature counters. For example, selecting quadrature mode for HSC 1 will use HSC inputs 1 and 2, which correspond to A and B quadrature signals. Therefore, HSC 1 and 3 may be configured for quadrature input. Alternately, HSC 3 may be configured to reset HSC1 (quadrature) count on a marker input

Quadrature mode works much like the totalizer except the accumulator will automatically increment or decrement based on the rotation phase of the two inputs. See the following example for more details. Quadrature inputs are typically used for reporting the value of an encoder.

Two modes are available for quadrature that select whether the accumulator counts up or down when the phase of input 1 leads input 2. Check your encoder's documentation to determine the output form it uses or try both modes to determine if the encoder counts up when expected.

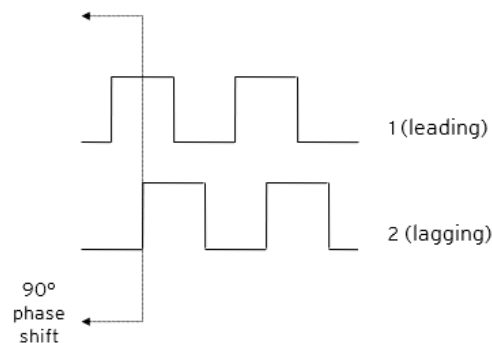

Using the above waveforms and a HSC input configuration of “Quadrature” - “1 leads 2, count up,” the accumulator will count up when 1 is rising and 2 is low, 1 is high and 2 is rising, 1 is falling and 2 is high, and when 1 is low and 2 is falling. This results in 4 counts per revolution. So in order to determine the number of cycles, the accumulator would have to be divided by 4.

Three different options are available to reset (or set) the current count:

- **Configured Counts per Rev Value** - When configuring the quadrature function, a value may be specified under the Counts per Rev column. When rotation produces an increasing count, the quadrature accumulator resets to zero on reaching the Counts per Rev count. Alternately, when rotation produces a decreasing count, the quadrature accumulator is set to Counts per Rev – 1 on the count following zero. Specifying zero for this value allows the totalizer to count through the full 32-bit range before resetting. For example, if your encoder outputs 1024 counts per revolution, the value of 1024 can be entered into the configuration for Counts per rev. This will result in a counter that produces counts in the range of 0 to 1023.
- **Ladder Control** - Setting registers %Q17 or Q19 resets quadrature (HSC) 1 or quadrature (HSC) 3 (respectively) with no additional configuration. Setting registers %Q18 or Q20 sets quadrature (HSC) 1 or quadrature (HSC) 3 (respectively) to Counts per Rev – 1.
- **Direct Digital Input Control (HSC3) [Marker]** - When HSC input 1 and 2 are used for quadrature inputs, an additional choice of marker input becomes available for HSC input 3. The marker input is typically part of an encoder or motion system that signals when a cycle of motion is complete. When the marker input is triggered, the accumulator is reset to zero or to Counts per rev - 1 based on rotation direction. Marker reset operation is enabled when HSC3 is configured for Marker type. Once selected, one of several modes is available for marker operation. These modes can be sub-divided into two groups of marker operation.

Asynchronous modes ignore the quadrature inputs and reset the quadrature accumulator to zero on the configured edge (rising, falling or both). These are the most common settings used. When configuring, asynchronous mode selections are prefixed with the word Async.

Synchronous modes synchronize the reset (or set) to the selected quadrature input and the selected marker polarity. Figure 11.1 below indicates which mode to select based on the markers timing diagram. Consult the documentation provided with your encoder to determine the marker pulse timing.

NOTE: The Marker input is sampled within 50µs of the associated quadrature edge. It is left to the user to determine if this meets the time constraints of the measured drive.

NOTE: If the Marker input pulse consecutively spans more than one of the specified edges, quadrature-decoding operation is unpredictable.

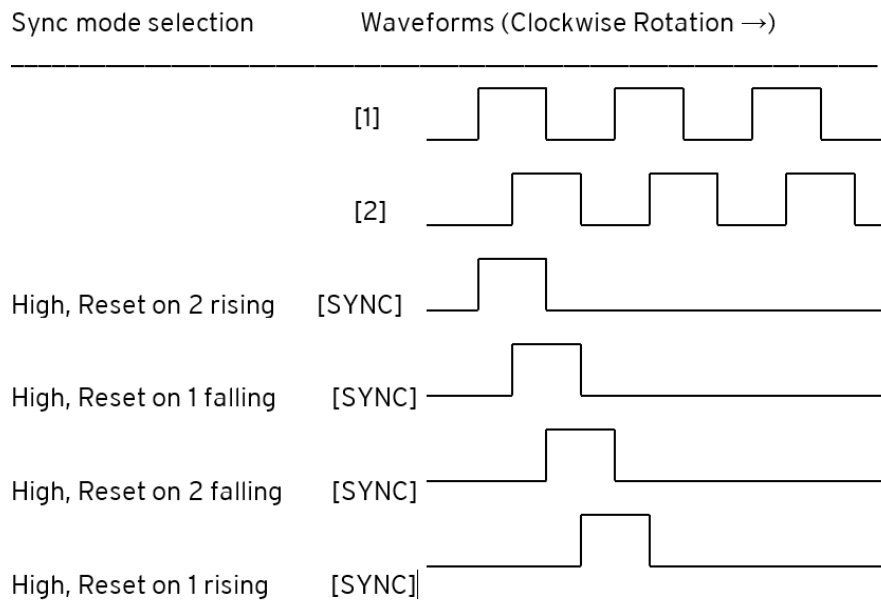

*While not displayed in this figure, modes for low level (inverse logic) are also supported for each state.

The accumulator is reset to zero on the specified edge if rotation is clockwise (as shown in figure above). However, if rotation is reversed, the accumulator is alternately set to Counts per rev – 1 on that same physical edge. When direction is reversed, that same physical edge is seen (by the internal decoder) as having the opposite edge polarity as shown below.

Sync Pulse Mode Table

Definition: CPR most commonly stands for Counts per Revolution, and refers to the number of quadrature decoded states that exist between the two outputs A and B. With both outputs A and B switching between high and low, there exists 2 bits of information represented as 4 distinct states.

Sync Pulse Mode Table					
Mode	Direction	A (HSC1)	B (HSC2)	Marker (HSC3)	Reset Value
Async, Reset on rising edge				Rising	0
Async, Reset on falling edge				Falling	0
Async, Reset on both edge				Both	0
High, Reset on 1 rising	Clockwise	Rising		High	0
“	Counter	Falling		High	CPR - 1
Low, Reset on 1 rising	Clockwise	Rising		Low	0
“	Counter	Falling		Low	CPR - 1
High, Reset on 1 falling	Clockwise	Rising		High	CPR - 1
“	Counter	Falling		High	0
Low, Reset on 1 falling	Clockwise	Rising		Low	CPR - 1
“	Counter	Falling		Low	0
High, Reset on 2 rising	Clockwise		Rising	High	0
“	Counter		Falling	High	CPR - 1
Low, Reset on 2 rising	Clockwise		Rising	Low	0
“	Counter		Falling	Low	CPR - 1
High, Reset on 2 falling	Clockwise		Rising	High	CPR - 1
“	Counter		Falling	High	0
Low, Reset on 2 falling	Clockwise		Rising	Low	CPR - 1
“	Counter		Falling	Low	0

HSC Register Map for XLE & XLT

HSC Register Map				
Register	Frequency	Totalize	Pulse	Quad
%AI5-6	HSC1 (function) Accumulator			Quad 1 Acc
%AI7-8	HSC2 (function) Accumulator			
%AI9-10	HSC3 (function) Accumulator			Quad 2 Acc
%AI11-12	HSC4 (function) Accumulator			
%AQ1-2		HSC1 Preset		
%AQ3-4		HSC2 Preset		
%Q17		Clear HSC1		Clear Quad 1
%Q18		Clear HSC2		Set Quad 1
%Q19		Clear HSC3		Clear Quad 2
%Q20		Clear HSC4		Set Quad 2

Pulse Width Modulation (PWM) Functions

On units that support the PWM, two dedicated outputs are available that can be configured for one of four modes of operation. Those modes are Normal, PWM, HSC (count = PV) and Stepper.

Normal - When either Q1 or Q2 is configured for Normal operation, the digital output registers %Q1 and %Q2 drives that respective output.

Pulse Width Modulation (PWM) Functions - When either Q1 or Q2 is configured for PWM, the PWM function drives that respective output. Both PWM channels may be individually enabled; however, when both PWM outputs are enabled, both share the same output frequency (with the low going pulses synchronized). Otherwise, each PWM's pulse width can be independently adjusted.

The PWMs require three parameters (%AQs) to be set for operation. These parameters may be set at run-time. The register set and prescale calculation differ depending upon the XLE/XLT hardware being used, hardware revs A-R use the following registers and scaling:

Prescale Count (Revision A-R) for Gen 1 - The prescale (%AQ5-6) count sets the resolution of the internal counter used for generating the PWM output. The (prescale count + 1) is a divisor applied to a 16MHz clock that drives the internal PWM counter. For the highest resolution PWM output, this value should be set as low as possible (0 provides a 1/16 micro second resolution). Both the Period and Duty cycle (pulse width) are based on counts of the internal PWM counter.

The frequency of the PWM output is calculated using the following formula:

$$\text{Frequency} = \frac{16,000,000}{(\text{Pr escaleCount}+1) \times \text{PeriodCount}}$$

Pre-scale Count Revision T and onwards for Gen 2 - The pre-scale %AQ5 (PWM1) or %AQ6 (PWM2) count sets the resolution of the internal counter used for generating the PWM output. The (pre-scale count + 1) is a divisor applied to a 32MHz clock that drives the internal PWM counter. For the highest resolution PWM output, this value should be set as low as possible (0 provides a 1/32 micro second resolution). Both the Period and Duty cycle (pulse width) are based on counts of the internal PWM counter.

The frequency of the PWM output is calculated using the following formula:

$$\text{Frequency} = \frac{32,000,000}{(\text{Pr escale}+1) \times \text{PeriodCount}}$$

On units that support the PWM, two dedicated outputs are available that can be configured for one of four modes of operation. Those modes are Normal, PWM, HSC (count = PV) and Stepper.

PWM Functions Register Map

PWM Functions Register Map			
Register	PWM	HSC	Stepper
%AQ1	PWM1 Duty Cycle (32-bit)	HSC1 Preset Value	Start Frequency
%AQ2			Run Frequency
%AQ3	PWM2 Duty Cycle (32-bit)	HSC2 Preset Value	Accel Count (32-bit)
%AQ4			Run Count (32-bit)
%AQ5	PWM Prescale (32-bit)		Run Count (32-bit)
%AQ6			Decel Count (32-bit)
%AQ7	PWM Period (32-bit)		Run
%AQ8			Ready/Done
%Q1			Error
%I30			
%I31			

When either Q1 or Q2 is configured for HSC operation, HSC1 or HSC2 totalize functions are extended to allow respective direct output control based on a comparison of the current count and a preset value (PV). See totalize in the HSC section above for more information.

PWM Examples - All of the PWM examples use the following formula.

$$\text{Frequency} = \frac{32,000,000}{(\text{Pr escale}+1) \times \text{PeriodCount}}$$

Example 1

To get a 50% Duty Cycle @ 10 kHz waveform on PWM1:

Set %AQ1 = 50 (duty cycle count)

Set %AQ5 = 30 (prescale count)

Set %AQ7 = 100 (period count)

Example 2

To get a 50% Duty Cycle on PW1 and 90 % Duty Cycle on PWM2 @ 1 kHz waveform:

Set %AQ1 = 500 (duty cycle count)

Set %AQ3 = 900 (duty cycle count)

Set %AQ5-6 = 30 (prescale count)

Set %AQ7-8 = 1000 (period count)

Example 3

To turn PWM 1 output ON all the time

Set %AQ1-2 = Same value as AQ7-8 (duty cycle count)

Set %AQ5-6 = Any value (prescale count)

Set %AQ7-8 = Non-Zero value (period count)

Example 4

To turn PWM 1 output OFF all the time

Set %AQ1-2 = 0 (duty cycle count)

Set %AQ5-6 = Any value (prescale count)

Set %AQ7-8 = Any value <or> 0 (period count)

Period Count

This value (%AQ7-8) sets the period of the output signal by specifying the number of internal PWM counter counts before the cycle is reset (larger count results in a smaller frequency). The duration of each count is determined by the pre-scaler value. This parameter affects the Period of both PWM outputs.

See the previous formula to see how the pre-scale and period counts create an output frequency. For example, setting the PWM for 1 μ s resolution (pre-scale=15), and a period count of 20,000 would result in a 50Hz output.

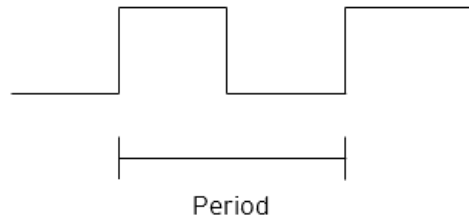

Duty Cycle Count

This value (PWM1: %AQ1-2, PWM2: %AQ3-4) sets the width of the output signal by specifying the number of internal PWM counter counts that the output is maintained high. The duration of each count is determined by the pre-scaler value. Each PWM channel has its own duty cycle count parameter.

Setting the period count to 1000 and the duty cycle count to 500 results in a duty cycle of 50 percent. Changing just the duty cycle count to a value of 250 results in a duty cycle of 25%.

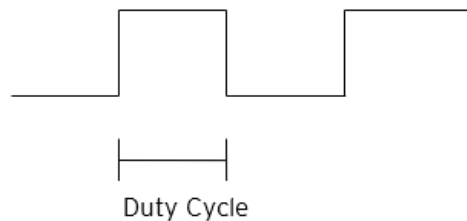

At controller power-up or during a download, the PWM output is maintained at zero until both the Period (count) and the Duty cycle (count) are loaded with non-zero values. When the controller is placed in stop mode, the state of the PWM outputs is dependent on the PWM State on Controller Stop configuration. This configuration allows for either hold-last-state or specific prescale, period and duty cycle counts. Specifying zero for either the period or duty causes the PWM output to remain low during stop mode.

NOTE: The nominal output driver turn-on-time delay (to reach 50% output) is 25 μ s on Models 3-5. Therefore, this limitation should be considered when determining both the minimum pulse width and the duty cycle accuracy of the application.

The following table shows the PWM registers used for the old and new revisions:

PWM Old and New Registers	
PWM Old Registers	PWM New Registers
AQ1 – PWM1 Duty Cycle(DWord)	AQ1 – PWM1 Duty Cycle
	AQ2 – Reserved
AQ3 – PWM2 Duty Cycle(DWord)	AQ3 – PWM2 Duty Cycle
	AQ4 – Reserved
AQ5 – Pre-Scale(DWord)	AQ5 – PWM1 Pre-Scale
	AQ6 – PWM2 Pre-Scale
AQ7 – Period(DWord)	AQ7 – PWM1 Period
	AQ8 – PWM2 Period

1. When an old XLE/XLT file is auto configured to a new XLE/XLEe or XLT/XLTTe file, then the old formula and registers are taken and firmware will do the required adjustments for the PWM to function normally.
2. When a new XLE/XLT file is created, then the new formula will be applied and the configuration must be as per the new register set.

PWM Wave Output Form

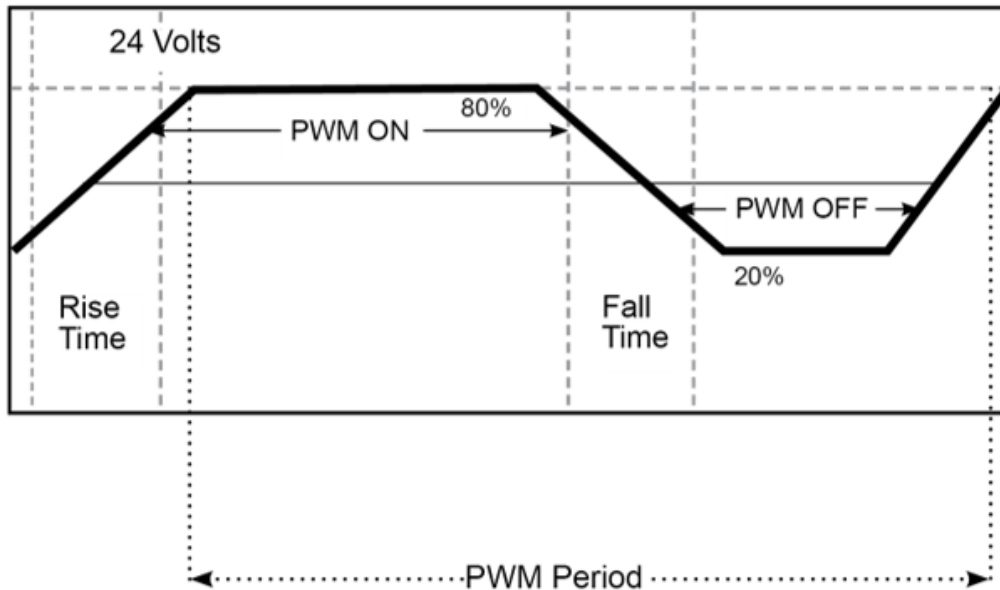

PWM Output Waveform Table	
Rise Time	150ns Max
Fall Time	150ns Max
PWM Period	Frequency = 1 / Period

HSC Output

When using I/O models equipped with solid-state outputs, the first two outputs may be used in conjunction with the first two High-Speed Counter inputs when those inputs are set to 'Totalize'. When the HSC accumulator matches or exceeds the preset value, these configuration options allow the output to turn ON, turn OFF, toggle, or pulse for a configurable amount of time.

The HSC Outputs function by comparing an HSC Input accumulator to its configured Preset value. With the Output Pulse option, a Pulse Time value is configured to determine the ON time. The location of these values may be found in the HSC function register map.

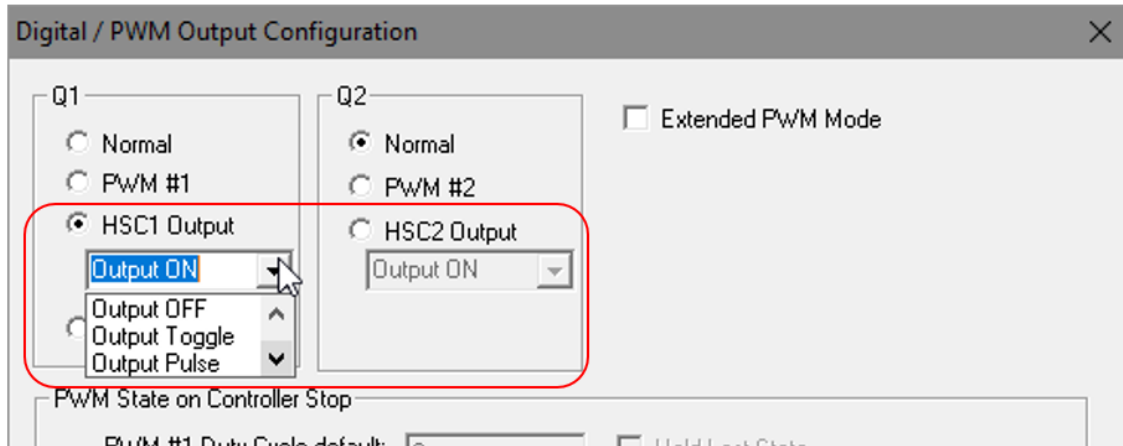

- **Output ON:** Starts with LOW. When the HSC accumulator becomes greater than or equal to the Preset value, the output will turn ON. Otherwise, it is turned OFF.
- **Output OFF:** Starts with HIGH. When the HSC accumulator becomes greater than or equal to the Preset value, the output will turn OFF. Otherwise, it is turned ON.
- **Output Toggle:** When the HSC accumulator becomes equal to the Preset value, the output will toggle, either from OFF to ON, or from ON to OFF.
- **Output Pulse:** When the HSC accumulator becomes equal to the Preset value, the output will turn ON and remain ON until the configured pulse time expires, then turn OFF. If another match occurs during the count-down to turn the output off, the pulse countdown restarts and the output remains ON until the countdown is complete.

NOTE: The output pulse time resolution is 50 μ .

NOTE: The state of outputs %Q1 and %Q2 are not reflected in their respective registers when selected for operation other than 'Normal'.

The Accumulator

When the counter accumulator matches the match value stored in %AQ registers, the HSC output will be enabled. The firmware will then wait based on the configurable microsecond pulse width. After the elapsed time, the output will be turned off.

If another match happens while the countdown to turn off the output, then the pulse countdown will restart but the output will not change state until the countdown happens.

When HSC1 accumulator value is equal to AQ1-2 UDINT value, then the Output Q1 becomes high for AQ27-28 UDINT value microseconds.

NOTE: Resolution for the pulse width will be limited to 50 microseconds on the XLE/XLT hardware.

NOTE:

- a. Match value is stored in register AQ3-4 UDINT for HSC2.
- b. AQ29-30 UDINT is Pulse width value for HSC2

Example 1:

Turn HSC1 Output ON if HSC accumulator 1 exceeds a count of 100,000.

Assuming HSC #1 is already configured to 'Totalize':

- Select 'HSC1 Output' and the 'Output ON' option
- Load UDINT value of 100,000 into %AQ1-2 HSC1 Preset value
- Download the program and input pulses to HSC #1
- Observe UDINT %AI5-6 HSC1 Accumulator value for the accumulated count.
- When %AI5-6 HSC1 Accumulator reaches and exceeds the Preset value, the output Q1 will turn ON.
- The output Q1 will remain on until HSC1 is cleared with the %Q17 bit.

Example 2:

Pulse the Q2 Output for 100 milliseconds when HSC accumulator 2 matches the value of 50,000.

- Assuming HSC #2 is already configured to 'Totalize':
- Select 'HSC2 Output' and the 'Output Pulse' option
- Load UDINT value of 50,000 into %AQ3-4 HSC2 Preset value
- Load UDINT value of 100,000 into %AQ27-28 Pulse Time
- Download the program and input pulses to HSC #2
- When %AI7-8 HSC2 Accumulator becomes equal to 50,000, the output Q2 will turn ON for 100 milliseconds and then turn OFF.

Stepper Function

Most controllers support two stepper functions, one on each high-speed output when in two counter mode. In four counter mode, the controllers support one stepper function.

Step Function - A signal that has a zero (0) value before a certain instant of time and a constant nonzero value immediate after that instant.



The Stepper requires five parameters (%AQ) to be set for operation. These parameters may be set at run-time but are 'latched' when the stepper is commanded to start:

Stepper Parameters	
Start Frequency (cycles per second)	<p>This value (%AQ1) sets the frequency for the first cycle during the acceleration phase and the frequency of the last cycle during the deceleration phase. When an acceleration or deceleration count is specified, the Start Frequency must be greater than zero (0) and must not exceed the run frequency or an error is generated.</p> <p>NOTE: For XLE/XLEe and XLT/XLT e controllers, the Start Frequency should be a minimum of 20Hz or more.</p>
Run Frequency (cycles per second)	<p>This value (%AQ2) sets the frequency for the last cycle during the acceleration phase, the consistent frequency during the run phase, and the frequency of the first cycle during the deceleration mode. The Run Frequency must be greater than zero (0) and must not exceed 5000 cycles/sec. or an error is generated.</p>
Acceleration Count	<p>This value (%AQ3-4) sets the number of cycles to occur within the acceleration phase. The frequency of the cycles within this mode will vary linearly between the specified Start and Run frequency. The Accel count must not equal 1 or an error is generated. Setting this value to zero (0) disables this phase.</p> <p>NOTE: For XLE/XLEe and XLT/XLT e controllers, Acceleration Count should be more than 300.</p>
Run Count	<p>This value (%AQ5-6) sets the number of cycles to occur within the run phase. The frequency of the cycles within this mode is constant at the specified Run frequency. The Run count may be any value. Setting this value to zero disables this phase.</p>
Deceleration Count	<p>This value (%AQ7-8) sets the number of cycles to occur within the deceleration phase. The frequency of the cycles within this phase will vary linearly between the specified Run and Stop frequency. The Decel count must not equal 1 or an error is generated. Setting this value to zero disables this phase.</p> <p>NOTE: For XLE/XLEe and XLT/XLT e controllers, Deceleration Count should be more than 300.</p>

The stepper provides two Boolean registers to provide stepper status:

Boolean Registers	
Ready/Done	A high indication on this register indicates the stepper sequence can be started (i.e. not currently busy) and also when the move is completed.
Error	A high indication on this register indicates that one of the analog parameters specified above is invalid or the stepper action was aborted before the operation was complete. This register is cleared on the next start command if the error was corrected.

The stepper requires one discrete register to control the stepper action. Setting this register starts the stepper cycle. This register must remain set to complete the entire cycle. Clearing this register before the cycle is complete aborts the step sequence and sets the error bit.

NOTE: Setting the PLC mode to stop while the stepper is in operation causes the stepper output to immediately drop to zero and the current stepper count to be lost.

NOTE: The stepper output level may cause damage or be incompatible with some motor drive inputs. Consult drive documentation to determine if output level and type is compatible.

STP Examples

Example 1

	Start Frequency	Run Frequency	Accel Count	Run Count	Decel Count
10,000,000 steps control sequence	Set %AQ421-2 = 2500 (Hz)	Set %AQ422-4 = 5000 (Hz)	Set %AQ423-6 = 1,000,000 (Steps)	Set %AQ425-8 = 8,000,000 (Steps)	Set %AQ427-30 = 1,000,000 (Steps)
When the start bit is energized, the example starts at 2.5kHz and ramps up to 5kHz during the first 1,000,000 steps. Then, it runs at 5kHz for the next 8,000,000 steps. Finally, during the last 1,000,000 steps it slows to a stop.					

Example 2

	Start Frequency	Run Frequency	Accel Count	Run Count	Decel Count
5,000,000 steps control sequence	Set %AQ421-2 = 500 (Hz)	Set %AQ422-4 = 1000 (Hz)	Set %AQ423-6 = 2,000,000 (Steps)	Set %AQ425-8 = 2,000,000 (Steps)	Set %AQ427-30 = 1,000,000 (Steps)
When the start bit is energized, the example starts at 0.5 kHz and ramps up to 1 kHz during the first 2,000,000 steps. Then, it runs at 1 kHz for the next 2,000,000 steps. Finally, during the last 1,000,000 steps it slows to a stop.					

Example 3

	Start Frequency	Run Frequency	Accel Count	Run Count	Decel Count
6,000,000 steps control sequence	Set %AQ421-2 = 50 (Hz)	Set %AQ422-4 = 250 (Hz)	Set %AQ423-6 = 150,000 (Steps)	Set %AQ425-8 = 5,500,000 (Steps)	Set %AQ427-30 = 350,000 (Steps)
When the start bit is energized, the following example starts at 50Hz and ramps up to 250Hz during the first 150,000 steps. Then, it runs at 250Hz for the next 5,500,000 steps. During the last 350,000 steps it slows to a stop.					

NOTE: Prior to the start of a move, the Ready/Done bit for that channel must be ON (%I1617 or %I1619 for channel 1 and 2 respectfully). The Ready/Done bit will turn OFF during the move, and then back ON once the move is completed.

NOTE: The pulse generation hardware on the OCS can generate any frequency that can be evenly divided into 10MHz (10,000,000Hz) under the maximum recommended frequencies for each model. This results in a very smooth operation at lower frequencies, with a progressively choppier operation at higher frequencies, as the units reach their maximum recommended frequency.

NOTE: The highest usable frequency is 65kHz for the PWM output. This is only achievable on a Model 6 unit, Models 2-5 max output frequency is approximately 10kHz.

Serial Communications



Serial Communications

Port Descriptions	105
Serial Port Wiring	106
Dip Switches	107
RS-485 Termination	108
RS-485 Biasing	108
Cscape Programming via Serial Port	108
Ladder-Controlled Serial Communication	108

All XLE/XLT models provide two serial ports, which are implemented with 8-pin modular RJ45 connectors and are labeled MJ1 and MJ2. The MJ1 serial port is normally used for XLE/XLT programming by connecting it to the COM port of a PC running Cscape. In addition, both MJ1 and MJ2 can be used for application-specific communication, using a variety of standard data exchange protocols.

Port Descriptions

The MJ1 serial port contains both a half-duplex RS-485 interface and an RS-232 interface with RTS/CTS handshaking.

NOTE: MJ1 shares its serial port with the optional COM module, so when an optional Modem COM or other module is installed and active, the MJ1 connector is inactive.

The MJ2 serial port contains both a full-duplex RS-485 interface and an RS-232 interface with no handshaking. Both the MJ1 and MJ2 RS-485 interfaces provide switchable termination and bias resistors internally. Also, both MJ1 and MJ2 can be set as the serial programming port.

Serial Port Wiring

MJ1 Wiring

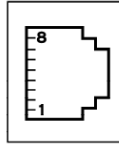

RS-232 with full handshaking or **RS-485** half-duplex
RS-485 termination via switches; biasing via software

MJ1 Pins		
PIN	SIGNAL	DIRECTION
8	TXD	OUT
7	RXD	IN
6	0V	GROUND
5	+5V @ 60mA	OUT
4	RTS	OUT
3	CTS	IN
2	RX-/TX-	IN/OUT
1	RX+/TX+	IN/OUT

MJ2 Wiring

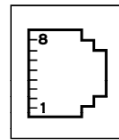

RS-232 or **RS-485** half or full-duplex, software selectable
RS-485 termination via switches; biasing via software

MJ2 Pins		
PIN	SIGNAL	DIRECTION
8	232 TXD	OUT
7	232 RXD	IN
6	0V	GROUND
5	+5V @ 60mA	OUT
4	485 TX-	OUT
3	485 TX+	IN
2	485 RX- or RX/TX-	IN or IN/OUT
1	485 RX+ or RX/TX+	IN or IN/OUT

NOTE: Attach optional [ferrite core](#) with a minimum of two turns of serial cable.

Dip Switches

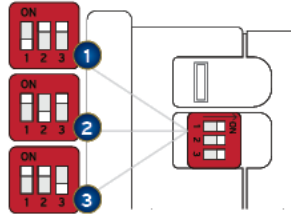

DIP Switches			
PIN	NAME	FUNCTION	DEFAULT
1	MJ1 RS-485 Termination	ON = Terminated	OFF
2	MJ2 RS-485 Termination	ON = Terminated	OFF
3	Bootload	Always Off	OFF

The DIP switches are used to provide a built-in termination to both the MJ1 port and MJ2 port if needed. The termination for these ports should only be used if this device is located at either end of the multidrop/daisy- chained RS-485 network.

RS-485 Termination

Proper RS-485 termination minimizes reflections and improves reliability.

Both serial ports allow an internal 121 Ω RS-485 termination resistor to be placed across pins 1 and 2. This can be done by installing a jumper / switching the dip switch.

NOTE: Only the two devices physically located at the endpoints of the RS-485 network should be terminated.

RS-485 Biasing

RS-485 biasing passively asserts a line-idle state when no device is actively transmitting, which is useful for multi-drop RS-485 networking.

Both serial ports allow internal 390 Ω RS-485 bias resistors to be switched in, pulling pin 1 up to 3.3V and pin 2 down to ground. The Set Serial Ports item in the System Menu chapter can be used to enable RS-485 biasing. Also, an application graphics screen that writes to %SR164 can do the same thing. Setting %SR164.1 enables MJ1 biasing and setting %SR164.2 enables MJ2 biasing.

If biasing is used, it should be enabled in only one of the devices attached to the RS-485 network.

Cscape Programming via Serial Port

If a PC COM port is connected to the XLE/XLT MJ1 serial port, Cscape can access the XLE/XLT for programming and monitoring.

Ladder-Controlled Serial Communication

Using Serial Communication function blocks, both MJ1 and MJ2 support Generic, Modbus Master and Modbus Slave Protocols. In addition, external modems can be connected and accessed using Init, Dial, and Answer Modem function blocks.

It is possible to load the program and monitor data via the USB 2.0 slave port on XLE/XLT Rev T and later. To load via USB, configure the communications port in Cscape as follows, the unit must be connected via the USB mini-USB port to the PC or laptop:

1. Select Tools from the **Toolbar**
2. Select **Applications Settings > Communications**.
3. Select the USB button.

It is possible to download/upload and use the data monitoring functions once connected.

NOTE: It is advisable to use an isolated USB cable between the PC/laptop and the XLE/XLT when third party devices are connected to the XLE/XLT to avoid damaging ground loops to the PC/laptop and/or the XLE/XLT.

CAN Communications



CAN Communications

CAN Connector	110
CAN Termination	111
Cscape Programming via CAN	111

Some XLE/XLT models provide a CAN networking port, which is implemented with a 5-pin connector, labeled **CAN1**.

The CAN1 port allows the XLE/XLT OCS to exchange global data with other OCS/RCS controllers and to access remote Network I/O devices (SmartStix, SmartBlocks and SmartRail Modules). The CAN1 port also supports pass-through communications for programming multiple OCS controllers over the CsCAN network. The port also allows the XLE/XLT to exchange global data with other OCS controllers and to access remote Network I/O devices.

The XLE/XLT CAN 1 port implements the ISO 11898-2 physical layer and the CAN 2.0A data link layer standards. Also, since the CAN 1 port is powered by an internal isolated power supply, external CAN power is not required.

CAN Connector

Use the CAN Connector when using CsCAN network.

- Solid/Stranded Wire: 12-24 awg (2.5-0.2mm).
- Strip Length: 0.28" (7mm).
- Locking spring-clamp, two-terminators per conductor.
- Torque, Terminal Hold-Down Screws: 4.5 – 7 in-lbs (0.50 – 0.78 N-m).
- V+ pin is not internally connected, the SHLD pin is connected to Earth
- ground via a 1MΩ resistor and 10 nF capacitor

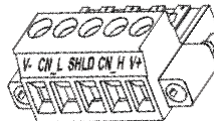

CAN Pin Assignments		
PIN	SIGNAL	DESCRIPTION
1	V-	CAN Ground – Black
2	CN_L	CAN Data Low – Blue
3	SHLD	Shield Ground – None
4	CN_H	CAN Data High – White
5	V+ (NC)	No Connect – Red

Solid/Stranded Wire: 12-24 awg (2.5-0.2mm).

Strip Length: 0.28" (7mm).

Locking spring-clamp, two-terminators per conductor.

Torque, Terminal Hold-Down Screws: 4.5 – 7 in-lbs (0.50 – 0.78 N-m).

V+ pin is not internally connected, the SHLD pin is connected to Earth ground via a 1MΩ resistor and 10 nF capacitor.

CAN Termination

Termination: 121Ω, 1%, 1/4watt or greater wattage is recommended. 120 ohm, 5%, 1/4 Watt or greater wattage may be used in most cases. Two termination resistors total should be used between CN_H and CN_L, one at each physical end of the network.

Cscape Programming via CAN

The CAN 1 port supports CsCAN Programming Protocol. If a PC has a CAN interface installed (via USB), and the PC CAN port is connected to the XLE/XLT CAN 1 port, Cscape can access the XLE/XLT for programming and monitoring.

In addition, the XLE/XLT supports single-point-programming of all XLE/XLT and other OCS devices that are connected to a CAN network. If the PC COM port is connected to the XLE/XLT programming port the XLE/XLT can act as a pass-through gateway allowing Cscape to access all XLE/XLT and OCS devices that are attached to the CAN network. Refer to "Serial Communications" on page 105 for more details.

Ladder-Controlled CAN Communication - Using Put and Get Network Words function blocks, the CAN 1 port can exchange digital and analog global data with other XLE/XLT or OCS/RCS devices (nodes) attached to the CAN network.

In addition, Put and Get Network Heartbeat function blocks allow nodes on the CAN network to regularly announce their presence and to detect the presence (or absence) of other nodes on the network.

Using CAN for I/O Expansion (Network I/O)

Connecting Network I/O devices (SmartStix Modules) to the XLE/XLT CAN 1 port, allows the XLE/XLT I/O to be economically expanded and distributed. A variety of XLE/XLT remote I/O modules are available for this purpose.

Ethernet Communication



Ethernet Communication

Ethernet Module Protocols and Features	113
Ethernet System Requirements	113
Ethernet Module Configuration	114
Ethernet Configuration - IP Parameters	117
Ethernet Module Protocol Configuration	117

For more details refer to the Ethernet Supplement, **SUP0740**, via the [Documentation Search](#) page on the Horner website.

NOTE: Supported by the XLEe and the XLTe only.

Ethernet Module Protocols and Features

The following table describes the Ethernet Module protocols and features supported by the Ethernet port on the XLEe/XLTe:

Ethernet Module Protocols / Features	
Protocol / Feature	Protocol / Feature Description
ICMP (Ping)	Internet Control Message Protocol
EGD	Ethernet Global Data
S RTP Slave (90-30 Service Request)	Service Request Transfer Protocol
CsCAN TCP Server	Horner APG CsCAN over Ethernet (for Cscape to OCS programming)
Modbus Slave	Modbus over Ethernet
Ethernet / IP	ODVA CIP over Ethernet
FTP (File Server)	File Transfer Protocol
ASCII Over TCP/IP	ASCII Data over Ethernet

Ethernet System Requirements

Full Ethernet functionality requires:

- PC running Cscape Programming Software Version 9.8 or later (for configuration).
- XLE/XLT controller with onboard Ethernet port.

Ethernet Module Specifications	
Speeds	10 BaseT Ethernet (10Mbps) 100 BaseTx Fast Ethernet (100Mbps)
Modes	Half or Full Duplex
Auto-Negotiation	Both 10/100Mbps and Half/Full Duplex
Connector Type	Shielded RJ-45
Cable Type (Recommended)	CAT5 (or better) UTP
Port	Auto MDI/MDI-X (Auto Crossover)

Ethernet Module Configuration

NOTE: The following configuration is required for all applications regardless of the protocols used. Additional configuration procedures must be performed for each protocol used.

To configure the Ethernet Module, use Cscape Programming Software to perform the following steps:
On the main Cscape screen, select the Controller menu and its Hardware Configuration sub-menu to open the Hardware Configuration dialog.

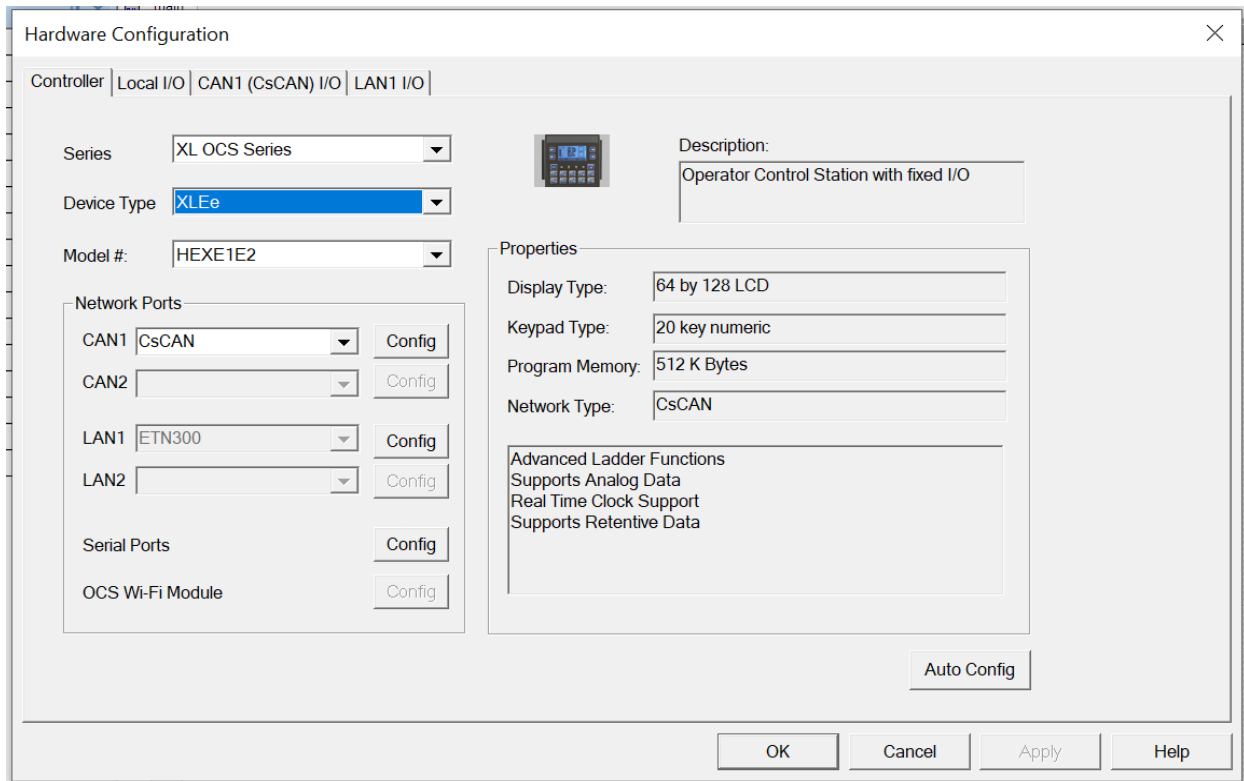

Click the Config button to the right of LAN1, revealing the Ethernet Module Configuration dialog:

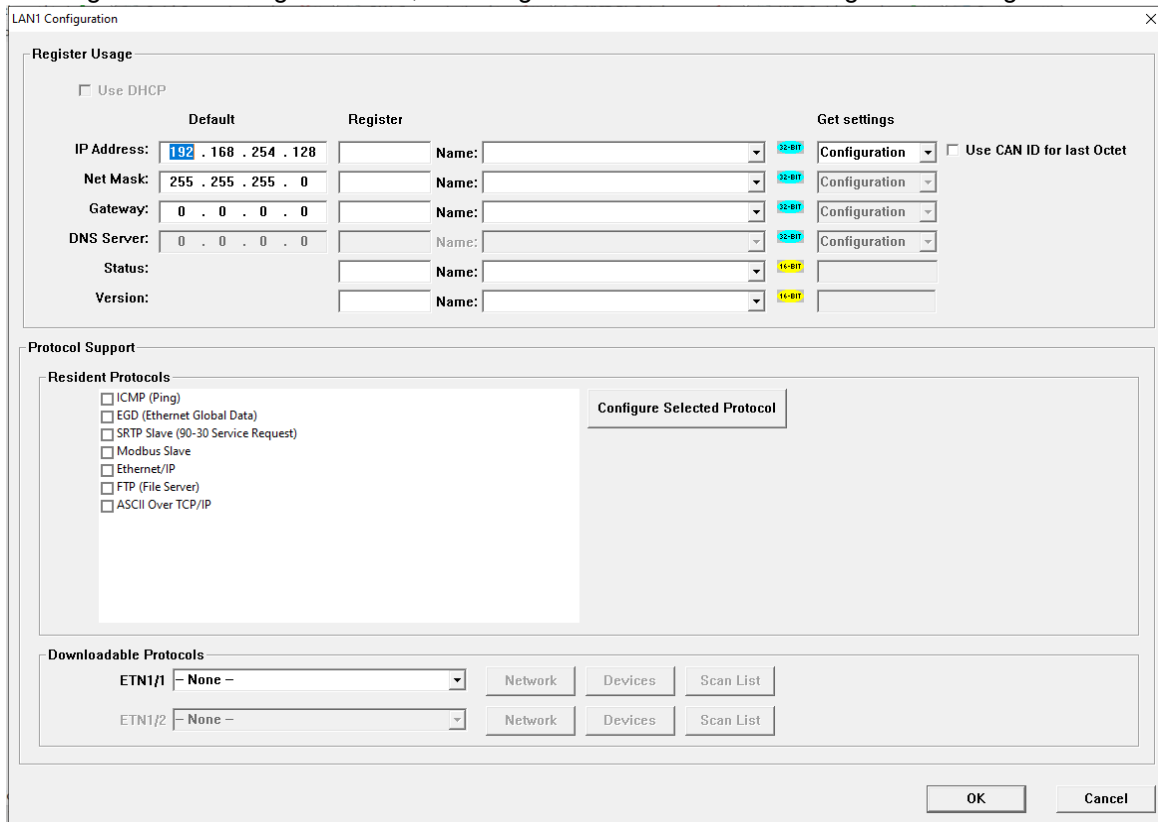

- **IP Address:** Enter the static IP Address for the Ethernet Module being configured. **NOTE:** IP Addresses are entered as four numbers, each ranging from 0 to 255. These four numbers are called octets and they are always separated by decimal points.
- **Net Mask:** Enter the Net Mask (sometimes called Subnet Mask) being used by all nodes on the local network. Typical local networks use Class C IP Addresses, in which case the low octet (rightmost number) is used to uniquely identify each node on the local network. In this case, the default Net Mask value of 255.255.255.0 should be used.
- **Gateway:** Enter the IP Address of a Gateway Server on the local network that allows for communication outside of the local network. To prevent the Ethernet Module from communicating outside the local network, set the Default Gateway IP Address to 0.0.0.0 (the default setting).
- **Status Register:** Enter an OCS Register reference (such as %R100) to indicate which 16-bit OCS register will have the Ethernet Status word written to it. Table 12.3 shows how this register value is formatted and explains the meaning of each bit in the Status Word.

Ethernet Status Word Register Format															
High Byte								Low Byte							
Bit 16	Bit 15	Bit 14	Bit 13	Bit 12	Bit 11	Bit 10	Bit 9	Bit 8	Bit 7	Bit 6	Bit 5	Bit 4	Bit 3	Bit 2	Bit 1
0	0	Dup	Spd	0	Rx	Tx	Link	TCP Connections							
Status Bit		Status Indication						Status Values							
								Minimum	Maximum						
0		Reserved						Always 0							
Dup		Link Duplex (Auto-Negotiated)						0 = Half Duplex	1 = Full Duplex						
Spd		Link Speed (Auto-Negotiated)						0 = 10 Mbps	1 = 100 Mbps						
Rx		Receive State						0 = Inactive	1 = Active						
Tx		Transmit State						0 = Inactive	1 = Active						
Link		Link State						0 = Down	1 = Up						
TCP Connections		Total Number of Active TCP Connections (CsCAN, SRTP, Modbus, EIP, FTP)						0	40						

- **Version Register:** Enter an OCS Register reference (such as %R101) to indicate which 16-bit OCS register will have the Ethernet Firmware Version written to it. The value stored in the Version Register is (Ethernet Firmware Version * 100). For example, for Ethernet Firmware Version 4.77, the version register will contain 477.
- **Get Settings From:** “Get settings from” allows the programmer to either configure the IP Address, Net Mask, or Gateway for two functions: Configuration or Register
 1. **Configuration** – The configuration for the IP Address, Net Mask, or the Gateway will be assigned using the value in the Default Settings in this window.
 2. **Register** – The configuration for the IP Address, Net Mask, or the Gateway will be assigned using the values in the registers assigned.

NOTE: The low octet of the IP Address can be replaced with the unit’s CAN Network ID, by checking the **Use CAN ID for last Octet** checkbox.

Ethernet Configuration - IP Parameters

For primary operation, the IP address, Net Mask, and Gateway should be set in the LAN Config of the Cscape Hardware Configuration. There are options to get IP parameters from the LAN Config or to get parameters from registers. It is possible to set the Ethernet IP parameters from the OCS System Menu, but only as a temporary measure. The following points on IP parameter configuration should be considered.

- IP Parameters in Non-Volatile RAM: The IP parameters of the Cscape LAN Config are written to non-volatile RAM on power down. IP parameter settings made in the System Menu are not written to non-volatile RAM. Any IP parameters settings made in the system menu will be lost after cycling power to the unit. It will revert back to the last downloaded Cscape LAN Config that was loaded into non-volatile RAM at power down.
- “Cscape LAN Config” / “Get Settings from” Configuration: When ‘Get settings from’ is set to Configuration, the IP parameters specified under ‘Default Settings’ is used after downloading to the controller. The IP parameters are represented in System Menu / Set Networks and can be edited. However, any edits made from System Menu / Set Networks is not retained through a power cycle. After power cycle, the unit reverts to the last downloaded Cscape LAN Config that was loaded into non-volatile RAM at power down.
- “Cscape LAN Config” / “Get Settings from” Register: When ‘Get settings from’ is set to Register, the IP parameters are retrieved from the OCS registers assigned in LAN Config. Configured registers must be populated with the desired IP parameters.
 - The IP parameters are represented in System Menu > Set Networks. The IP parameters cannot be edited from System Menu > Set Networks while the unit is in run mode. The IP parameters always follow the values in the registers unless the OCS unit is placed in idle mode.
 - Then the IP parameters can be edited in System Menu > Set Networks.
 - When the OCS is placed back into run mode, it reverts to the registers for IP parameters.

Ethernet Module Protocol Configuration

The Protocol Support area contains a list of all the protocols supported by the platform being configured. To activate a protocol, check its checkbox.

For protocols that require additional configuration, click on a listed protocol to select it and then click the Configure Selected Protocol button. This will open a new dialog with configuration options for the selected protocol.

For detailed information on individual protocol configuration refer to Ethernet topic in the Help File.

Downloadable Protocols



Protocol Configuration

Overview	119
Protocol Device Driver Selection	120
Network Configuration	121
Device List and Device Configuration	123
Scan List	125

Overview

Through loadable protocol device drivers, certain models of the OCS family can provide the ability to exchange data with remote devices such as variable-frequency drives, PLCs and remote I/O devices. This feature greatly expands the OCS's control capability with negligible effect on the OCS's ladder scan time.

Remote devices that communicate serially must do so under certain rules of data transfer known as a protocol. Many device manufactures have created their own protocol for communications with their device. For a OCS to communicate with a specific device, it must be loaded with the corresponding serial communications protocol device driver that supports that protocol.

A limited number of protocol device drivers are packaged with the Cscape distribution; however, as more are developed, they will be made available as add-on packages. A device driver is typically distributed as a Windows module, which contains the configuration menus, help files and the target executable driver code. When updating device drivers, an install routine loads the device driver to the Cscape directory structure and makes that driver available to Cscape applications.

Once installed, the protocol device driver can be included as part of a Cscape application by selecting it from a list of installed protocol device drivers and attaching it to the desired serial port (**Home > Protocols**). Only one protocol device driver can be associated with a serial port, though some OCS models support multiple protocols on a single Ethernet port.

Once the protocol is selected for a specific port, that port must be configured to match the bit transfer size and rate of the target device(s). This is configured under the **Network Config** menu, which contains port specific information such as the basic serial port parameters (i.e. baud rate, stop bits parity, retries, etc.). In addition to the serial port parameters, this menu also contains the transaction scan update control configuration and any network level protocol specific configuration.

Once the network is configured, each device on the serial communications network must be configured. For some communications (i.e. RS232), the network can be limited to one device. The devices are configured under the **Device Config** menu, which contains an arbitrary device name, the device ID and optionally a OCS status register that contains any device fault information.

Once each device(s) is configured, a Scan List of entries must be created which defines the transfer of data between a local (OCS) register(s) and a remote device register(s). These entries are created under the Data Mapping menu, which contains a OCS register, a target device ID, a target device register address, the number of registers to transfer, and update type.

Each entry can be configured for one of two types of initiating a transaction: **Polled and Triggered**. Polled type entries initiate a transaction with the remote device on every transaction scan. Triggered type entries only initiate a transaction when a corresponding local (OCS) binary trigger register is set. Once a triggered type transaction completes, the protocol device driver resets the local (OCS) binary register to indicate completion.

These basic types are also subdivided into read or write operations. For polled operations, a Read operation only reads from a remote device. Likewise a Read/Write operation continuously reads from the remote device unless the target OCS register value changes from one ladder scan to another. In this case, the new OCS value is written to the target device. For triggered operations, only a read or write action is available.

When downloaded to the OCS, the Scan List is scanned sequentially to generate data transactions with the remote device. This transaction scanning can be on a continual basis (**automatic**) or controlled from ladder logic (manual) once a complex connection is created via a program. The specific transaction-scanning mode is selected from the **Network Config** menu.

Protocol Device Driver Selection

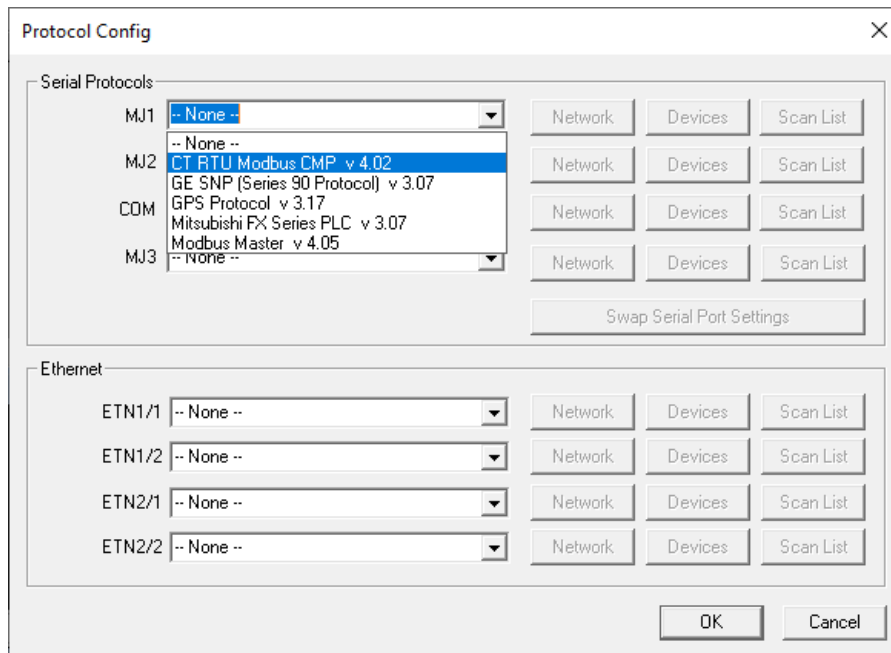

From the Cscape **Home > Protocols** menu, select the port drop-down box to select a protocol device driver. All protocol device drivers currently loaded in Cscape are displayed in the drop down selection along with their version numbers. A selected protocol can be removed by selecting **None** from the drop-down selection. Some OCS models can be limited in the number of ports or number of protocol device drivers that can be selected. Once a protocol is selected, the Network, Devices and Data (Scan List) must be configured through corresponding dialogues accessible through the respective buttons (Network, Devices and Scan List).

Network Configuration

Network Config (Modbus Master)
✕

Port Configuration

Baud Rate: <input type="text" value="9600"/>	Protocol: <input type="text" value="Modbus RTU"/>
Parity: <input type="text" value="None"/>	Mode: <input type="text" value="RS-232"/>
Data Bits: <input type="text" value="8"/>	Retries: <input type="text" value="2"/> (0-255)
Stop Bits: <input type="text" value="1"/>	Timeout: <input type="text" value="10000"/> mSec
Handshake: <input type="text" value="None"/>	Slave Speed: <input type="text" value="Fast"/>

Update Scan

Automatic

Update Interval: mSec ReacquireTime: mSec

Manual

Trigger: Name: 1-BIT

ID Select: Name: 16-BIT

Master ID / Address

Address:

Disable Network

Register: Name: 1-BIT

Status

Register: Name: 4 x 32-BIT

Protocol Help
OK
Cancel

Network Configuration provides the required parameters to configure the network. Each protocol is different and may not require the entire Network Config field. Please refer to the table below for the options in the Network Config field.

Network Protocols		
Baud Rate, Data Bits, Stop Bits, Parity	These field define the bit level transfer over the serial port.	
Handshake	<p>None – No handshake lines are used</p> <p>Multidrop Full – Rx remains active while Tx is occurring.</p> <p>Multidrop Half – Rx is shut off while Tx is occurring.</p> <p>Radio Modem – Wait for CTS acknowledgment before transmitting (legacy radio modem support).</p>	
Protocol	If a driver supports multiple protocols, it is selected here, (i.e. Modbus supports RTU or ANSI).	
Mode	Specifies if port operates in RS232 or RS485 mode.	
Retries	Specifies number of times a transaction is retried on a failed response.	
Timeout	Specifies the amount of time for a device to wait for a valid response.	
Update Scan	Automatic	<p>Update Interval – Specifies the update interval at which all the mapped entries are executed.</p> <p>Reacquire Time – Specifies the amount of time to wait before attempting communications with an offline device.</p>
	Manual	<p>Trigger – Specifies the binary register that a single transaction scan of the Scan List.</p> <p>ID Select – If an analog is specified in the field, the ID Select filter is enabled.</p>
Status Register	Specifies the starting OCS register of eight (8) consecutive registers (4-32bit counters), which provide an indication of the network health.	
Scanner Address	Specifies the OCS's device (network) ID if a master ID is required by the protocol.	
Protocol Help	Provides protocol specific help.	

Device List and Device Configuration

Device List

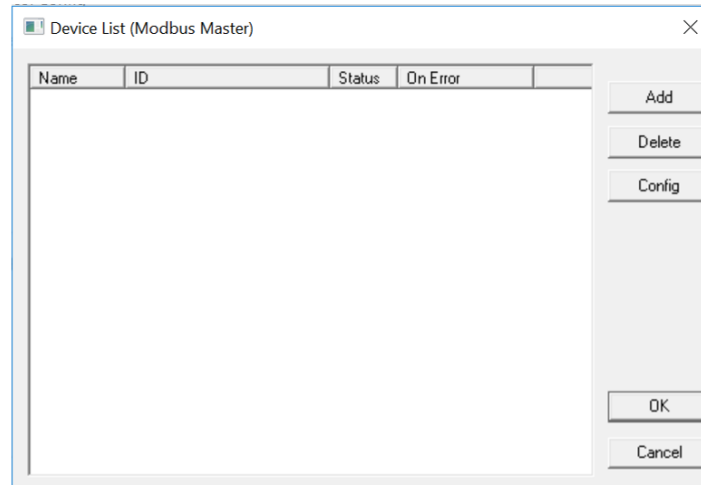

This configuration list is reached from the Device button on the Protocol Config screen and provides a list of the configured devices on the Network. Devices must be created and exist in this list before corresponding Scan List entries can be created for this device. Typically, the number of entries is limited to **128 devices**.

- **Add** - Opens the Device Config dialog to add a new device to the list.
- **Delete** - Remove selected device from list (all corresponding Scan List entries are also removed).
- **Config** - Invoke the Device Config dialog for the currently selected device. This can also be accomplished by double-clicking a device entry.
- **Mapping** - Invoke the Scan List limiting the entries displayed for the selected device.

Device Configuration

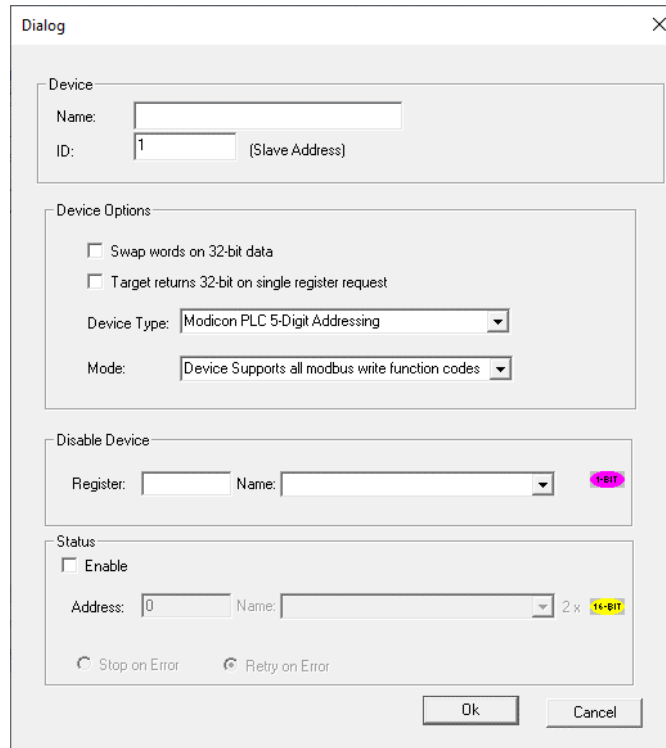

This configuration is reached from the device list when adding or modifying an existing device. While each protocol is somewhat different and can contain protocol specific field, all protocols typically support at least:

- **Device Name** - Specifies a tag name for this device. This tag name is used in the Data Mapping configuration to identify this device. This allows device addresses to be modified without the need to update all associated Data Mapping entries.
- **Device ID** - Specifies the target device communications ID or station address.
- **Swap Words on 32-bit Data** - If a Scan List entry is configured to transfer 32-bits and this option is checked, the high and low 16-bit values are swapped when transferred between the target and OCS.
- **Disable Device** - From Cscape 9.90 SP3 and firmware 15.40 onwards, disable device feature has been added in protocol device configuration. This option is used to disable a particular slave configured in the network. Single bit register has to be configured to use this function. Setting the bit high disables the slave and OCS will not send any serial (TCP for ethernet protocols) packets only to this slave until the bit is high. Setting the bit low enables the communication with the slave again.
- **Status Enable** - This checkbox enables device status to be displayed and controlled from two consecutive 16-bit registers.
- **Status Address** - Enter the starting 16-bit OCS register of two consecutive registers used for device status. The first register contains the protocol device driver specific error code while the second register contains the index of the offending Scan List entry.
- **Status Modes:**
 - a. **Stop on Error** - Specifies that communications be only reattempted after offline status when the corresponding device status register is cleared.
 - b. **Retry on Error** - Specifies that communications be reattempted either during the reacquire interval or when the corresponding device status register is cleared.

Scan List

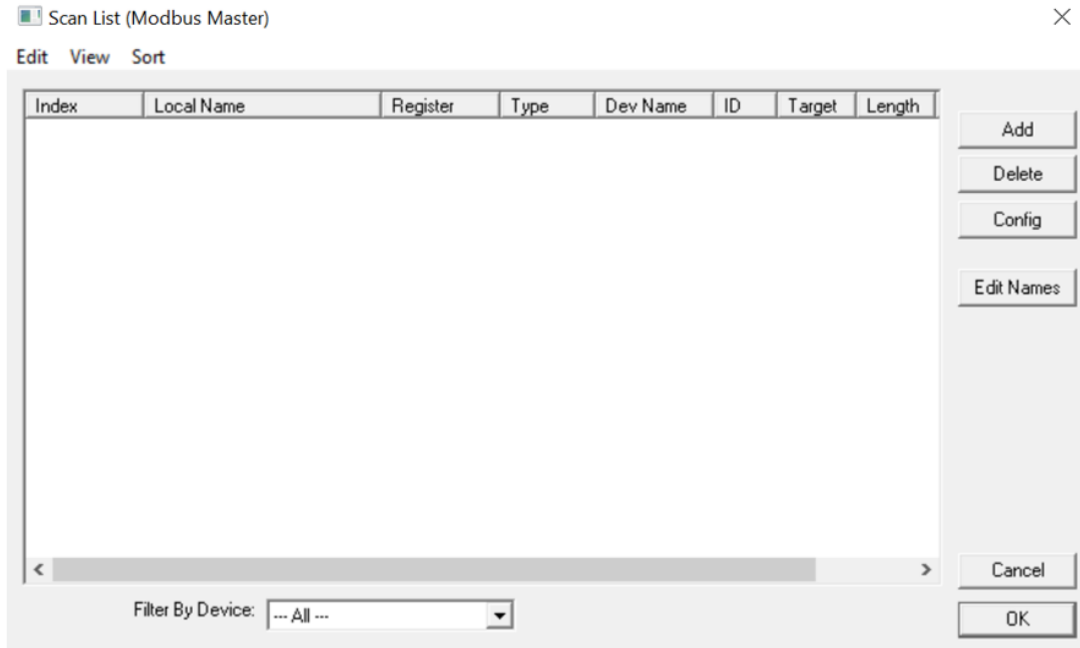

This configuration list is reached from the Scan List button on the Protocol Config screen or the **Mapping** button on the Device List screen and provides a Scan List of the Data Mapping entries. To transfer data between the OCS and remote target, a Scan List must be created that defines each transaction. Each mapping entry (transaction) contains the source and destination registers, the number of consecutive registers transferred, the direction of the transfer and what triggers the transfer. Typically, **the number of entries is limited to 512**.

NOTE: The order of the Scan List is the order in which the transactions occur. Sort functions are provided to change the order of the list. Each entry also has an identifying index. If the device status register is enabled and a transaction failure occurs, the status register indicates the index number of the transaction that failed.

Menu

- **Edit > Copy All** - Copies Scan List to clipboard in a tab delimited format suitable for pasting into an application like Microsoft Excel.
- **Edit > Paste** - Loads Scan List from clipboard. Pasted items are added to the scan list even if they are duplicates.
- **View > Toggle All Name View** - Expands Scan List such that each point and corresponding local name is displayed.
- **Sort** Scan List by different criteria. The firmware will scan the devices based on the order they are displayed or sorted. There are four ways to sort the scan list:
 - a. **By Local Address** – Sorts the list by local register address in increasing order.
 - b. **By Target Address** – Sorts the list by target register address in increasing order.
 - c. **By Device Name** – Sorts by device name, then target address.
 - d. **Interleave Devices** – This sort evenly distributes request among the different devices. Instead of requesting 100 blocks from device A, then 100 blocks from device B, one requests is sent to device A, then one request is sent to device B until all the data has been requested. This is useful for devices that may have a timeout timer because the time between each scan for a particular device is minimized. This sorting options usually doesn't affect performance.

Buttons

- **Add** - Opens the Data Mapping dialog to add a new entry to the Scan List.
- **Delete** - Removes selected entry from Scan List
- **Config** - Opens the Data Mapping dialog for the currently selected entry. This can also be accomplished by double-clicking an entry.
- **Edit Names** - Invokes the Edit Names dialog for the currently selected entry. The Edit Names dialog provides the ability to create OCS program names for each point in the transaction.

Display Control

Filter by Device - Limits displayed entries to only those assigned to the indicated device. To show all entries select **-All-**.

Data Mapping Configuration (Scan List Entry)

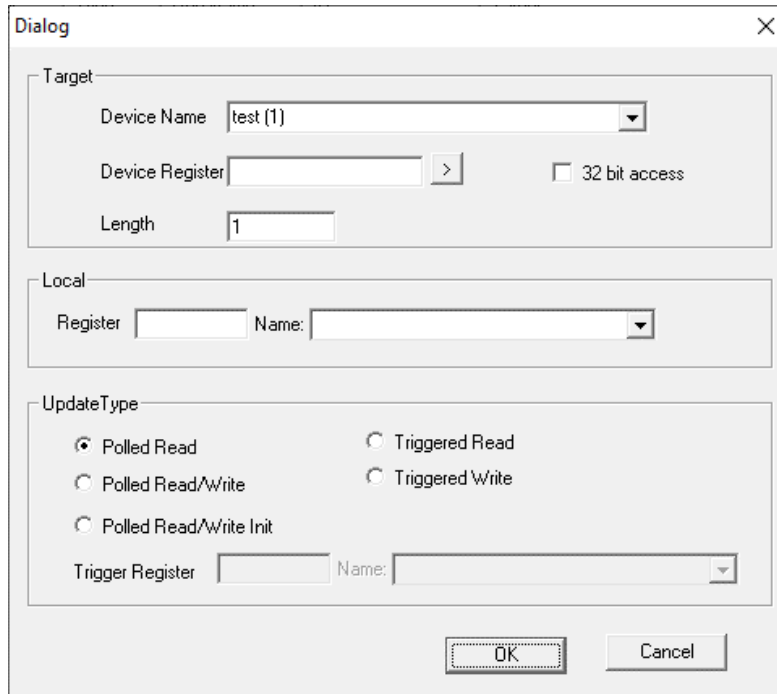

Target

- **Device Name** - Selects the target device (by tag name) to use for this transaction. Only those device entries previously created from the Device Config menu are available.
- **Device Register** - Specifies the target device's register to use for this transaction. This designation is target-specific. The configuration menu displays an error if a specified address is unacceptable. **Generally, the data type of the local (OCS) register must match the data type of the device register.**
- **The Right Arrow button** - Displays protocol device driver specific help for the target addressing. Note that some devices can require register addresses that exist on 8-bit, 16-bit or 32-bit boundaries.
- **Local Register** - Specifies the local (OCS) register that is the source or destination for the transaction.
- **Local Name [Optional]** - Optionally allows selection of a OCS register by name <or> creation of a name for a register already selected by direct reference. Created names can be used thereafter to specify the local (OCS) register in ladder or graphics address fields.
- **32-Bit Access** - Allows two local (OCS) 16-bit registers to be treated as a single 32-bit value. For example, if the value in either 16-bit register is modified, both registers are written to the device. Device-specific, 32-bit word swapping options also apply to this designation. Since the transaction is treated as a 32-bit access, the length is generally limited to 16. Note that some protocols can disable this feature.
- **Length**
 - a. Specifies the number of consecutive device registers that are transferred in this transaction. Note that some protocols can limit the length that can be transferred. However, typically the **length is limited to 32**. The configuration menu displays an error if a specified length is unacceptable.
 - b. **If allowed, specifying a length greater than one (multiple consecutive register transfers per transaction) is more efficient than creating a single transaction for each register.** This grouping of registers per transaction can significantly reduce the transaction scan time; however, **update types that include writing on a polled basis require additional consideration.**
 - c. On **Read/Write** and **Read/Write/Init** update types, the write transaction only occurs when the local (OCS) register value changes. If the length is greater than 1 for Read/Write and Read/Write/Init types, only the local register(s) that change in value are written. More specifically, only one write

transaction occurs per scan per mapping entry for the register or consecutive sub-group of local registers that changed in value. Depending on the protocol, the number of points written with that write transaction are limited either to one or the number of consecutive points that changed value.

- d. **Therefore, if several local registers (specified in a single mapping entry) change in value prior to a transaction scan, it takes SEVERAL transaction scans to complete all the write operations. Furthermore, all write operations are completed before a read operation is scheduled.**
- e. **For Manual Update (transaction) scans (i.e. dialup modem), it is recommended that all Read/Write Scan List entry lengths be limited to 1.**

Update Type

This field specifies the direction and what triggers the transfer of data between the OCS and target device for a mapping entry.

- **Polled Read** - On every transaction scan, a read-only target device register(s) transaction occurs.
- **Polled Read/Write**
 - a. On every transaction scan, a read target device register transaction occurs unless a local register value has changed. The write transaction only updates those local registers that have changed in value. If several non-consecutive local registers (contained in a single mapping entry) change value between transaction scans, it takes several consecutive transaction scans to write each changed register.
 - b. When the OCS is placed in RUN mode, **the initial action for this mapping type is a read target register transaction**. This transaction initializes the local (OCS) register(s) to match that of the remote device register(s). Thereafter, any change to the corresponding OCS register(s) triggers a write operation to the remote device.
- **Polled Read/Write/Init**
 - a. On every transaction scan, a read target device register transaction occurs unless a local register value has changed. The write transaction only updates those local registers that have changed in value. If several non-consecutive local registers (contained in a single mapping entry) change value between transaction scans, it takes several consecutive scans to write each changed register.
 - b. When the OCS is placed in RUN mode, **the initial action for this mapping type is a write target register transaction**. This transaction initializes the target device register(s) to match that of the local (OCS) register(s). Thereafter, any change to the corresponding OCS register(s) triggers a write operation to the remote device.
 - c. The initial write transaction does not occur until after the first logic scan of the OCS . This allows registers to be initialized locally before Writing to the target device register(s).
- **Triggered Read** - A read transaction is triggered by a high level on a separately designated OCS (binary) trigger register. Once the read transaction is complete (or the device is offline), the OCS trigger register is cleared by the OCS . This update type can be used for occasion data accesses such as retrieving trend data. Note that this operation increases the associated transaction scan time and can cause the **Update Interval Exceeded Counter** to increment on a tightly adjusted update interval.
- **Triggered Write** - A write transaction is triggered by a high level on a separately designated OCS (binary) trigger register. Once the write transaction is complete (or the device is offline) the OCS trigger register is cleared by OCS . This function can be used for occasion data accesses such as sending recipe data. Note that this operation increases the associated transaction scan time and can cause the **Update Interval Time Exceeded Counter** to increment on a tightly adjusted update interval.

User Interface



User Interface

Screen Navigation	130
Using Editable Screen Objects	131
Ladder Based Screen Navigation	131
Alarms	132
Screen Saver	134
Screen Brightness	134

This chapter presents the user interface (or operator view) of the XLE/XLT and some of the model specific characteristics of the XLE/XLT as compared to the rest of the OCS line. This chapter does NOT cover building screens or using the CSCALE Graphics Editor. For instructions on creating screens and using the graphics editor, refer to the Graphics Editor Help file in CSCALE.

Screen Navigation

The screen navigation on the XLE/XLT is quite flexible. Basic methods will be described here. Control programming can be used to create complex screen navigation techniques.

One form of screen navigation is the Jump Screen graphics object. This object is typically tied to a soft key (One of the four keys to the sides of the display for the XLE and at the bottom of the screen for the XLT). Pressing the soft key will switch to the screen that is programmed.

XLE Typical Screen Jump Object

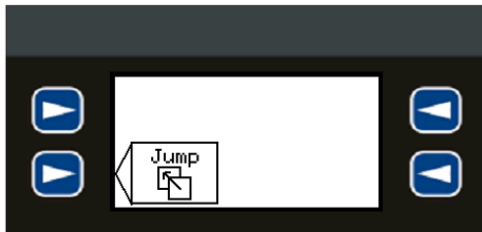

XLT Typical Screen Jump Object

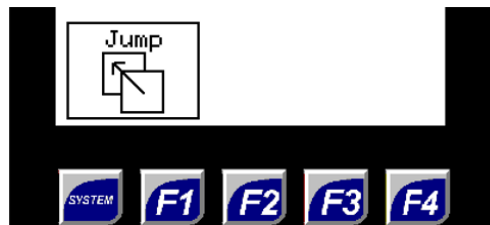

Screen jumps can also be triggered on other keys or based on control logic for more advanced applications. To allow the operator to change screens, a screen jump object is generally used. This object may be visually represented as a button (responding to touch) or remain invisible and logically tied to an OCS register. An optional system ICON may be configured for display along with the legend, which aids in identifying the object as one that causes a screen change.

Using Editable Screen Objects

When a screen contains editable objects, one of the objects will be selected by default. Selected objects will be outlined with a dotted line. The arrow keys can be used to navigate the editable objects and allow selection of an object to edit. When the object to be edited is selected press the Enter button. This enters the objects editing mode.

The most common editable object is the numeric object.

The value chosen by the operator cannot exceed the minimum or maximum set by the user program. If the user tries to exceed the maximum point or enter a value below the minimum point, the value will not change.

NOTE: If the XLE/XLT displays >>>>> in a numeric field, the value is too big to display in the field or is above the maximum for an editable field. If the XLE/XLT displays <<<<< in a numeric field, the value is too small to display or is below the minimum for an editable field.

XLE Specific - When in edit mode, a cursor appears on one digit of the editable field. Use the direction keys ← and → to move the cursor to the desired position. Use the ↑ and ↓ keys to increment or decrement the digit or enter the number/data with the alphanumeric keys.

XLT Specific - The most common editable object is the numeric object. To edit, touch the object and the pop-up keypad will appear to allow editing of the value.

Ladder Based Screen Navigation

Ladder logic can use several techniques to control screen navigation. Coils can be tied to %D registers to make them screen coils. These coils have two modes: switch and alarm. If the ladder program energizes an alarm display coil, the screen associated with this coil is displayed and overrides the normal user screens. This is designed to show alarm conditions or to display other ladder-detected events. When the text coil is de-energized, the previous screen that was being viewed before the alarm is returned.

The switch display coil switches to the associated screen when it is energized. Once it is de-energized the screen remains until it is switched by the user or ladder.

Force and Switch Coils in Ladder Programming in Cscape

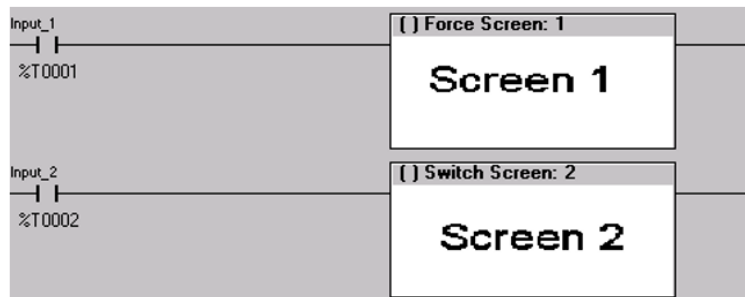

There is also a system register that can be used to for control-based screen navigation. %SR1 can be read to determine the current screen or written to change the current screen.

Refer to the Online Help in Cscape for more information on control-based screen navigation.

Alarms

Alarm presentation to the operator is highly configurable and beyond the scope of this document to describe fully. The alarm object is generally used to enunciate alarms to the operator.

For more information, refer to the **Graphics Editor** Help File in Cscope. This section presents a typical configuration thereby providing an introductory description on what the operator should expect.

To open the Alarm Configuration dialog, click on the **Graphics Editor** icon in the menu tool bar.

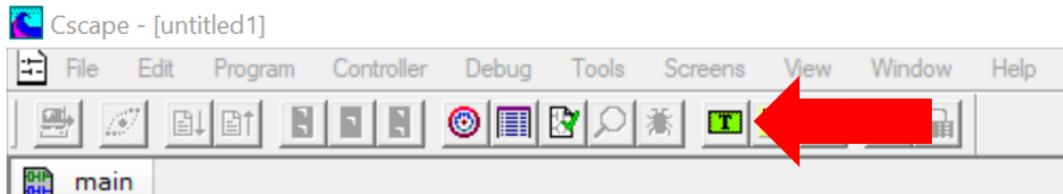

Then select **Config > Alarm** from the tool menu bar to open the Alarm Configuration dialog.

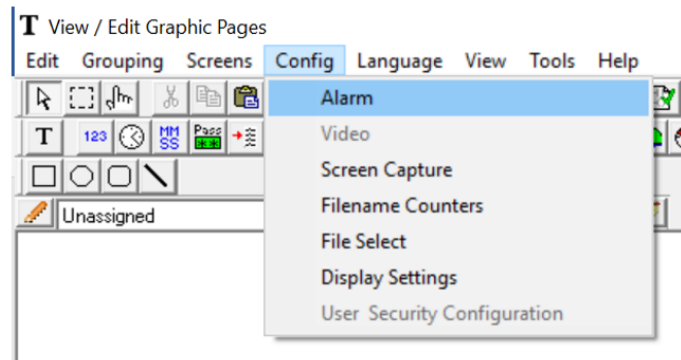

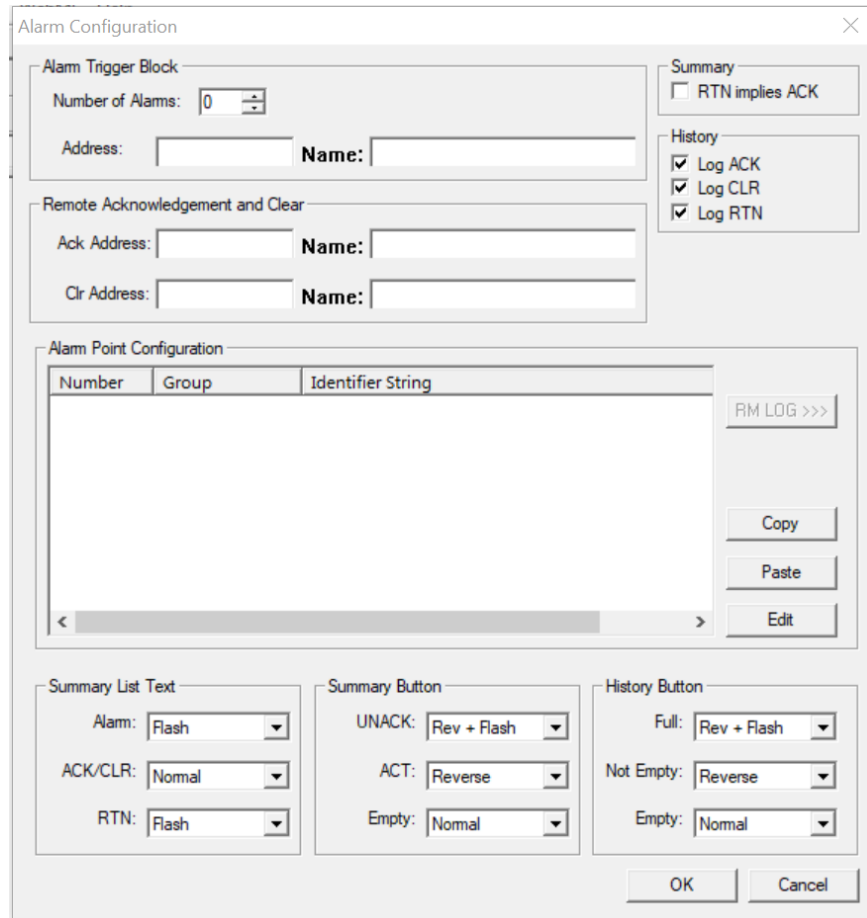

The Alarm Configuration dialog box is divided into several sections:

- Alarm Trigger Block:** Includes a 'Number of Alarms' spinner set to 0, and 'Address' and 'Name' text boxes.
- Remote Acknowledgement and Clear:** Includes 'Ack Address' and 'Name' text boxes, and 'Clr Address' and 'Name' text boxes.
- Summary:** A checkbox for 'RTN implies ACK'.
- History:** Three checked checkboxes for 'Log ACK', 'Log CLR', and 'Log RTN'.
- Alarm Point Configuration:** A table with columns 'Number', 'Group', and 'Identifier String'. Below the table are buttons for 'RM LOG >>>', 'Copy', 'Paste', and 'Edit'.
- Summary List Text:** Three dropdown menus for 'Alarm' (Flash), 'ACK/CLR' (Normal), and 'RTN' (Flash).
- Summary Button:** Three dropdown menus for 'UNACK' (Rev + Flash), 'ACT' (Reverse), and 'Empty' (Normal).
- History Button:** Three dropdown menus for 'Full' (Rev + Flash), 'Not Empty' (Reverse), and 'Empty' (Normal).

At the bottom are 'OK' and 'Cancel' buttons.

To view, acknowledge, and/or clear alarms, the operator must access the alarm viewer. This is accomplished by selecting an alarm object. When accessed, the alarm object is displayed as pop-up alarm viewer dialog similar to that shown in Figure 14.5. If more entries exist than can fit on the page, a scroll bar is displayed on the right side that also indicates the current relative position.

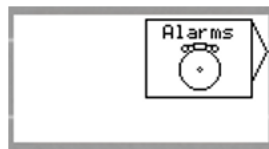

Once view operations are complete, simply touch the Esc button to remove the pop-up alarm viewer.

NOTE: OCS registers %SR181 and %SR182 are available for ladder use, which indicate presence of unacknowledged or acknowledged alarm (respectively). The screen designer may implement these registers to switch screens or activate the beeper to attract the operator's attention.

Screen Saver

The XLE/XLT screen backlight life remains sufficiently bright for five (5) years. It will dim to 70% brightness if it is left on continuously for five (5) years. If the application does not require interaction with the OCS for long periods of time, the backlight life can be extended by using the screen saver function. When enabled through the System Menu, the backlight is shut off (screen goes black) after a specified time of no activity on the screen. When the screen saver shuts off the backlight, any key or button reactivates the backlight.

It is possible for the application to temporarily disable the screen saver by generating a positive transition to %SR57.16 (coil only) at a rate faster than the screen saver timeout value. This may be desired while waiting for alarm acknowledgment.

NOTE: The backlight life can be extended by dimming or powering off the backlight.

Screen Brightness

The XLT provides a feature that allows screen dimming for night operation. To enable this feature, the application must access and control system register %SR57 (Display Backlight Brightness). Screen brightness is continuously variable by driving %SR57 through the range of 100 (full bright) to 0 (full off). It is left to the screen designer on if and how to present a Screen Brightness control to the user.

NOTE: Only the XLT offers a screen dimming function.

NOTE: The backlight life can be extended by dimming or powering off the backlight.

Removable Media



Removable Media

microSD Cards	136
Using the Removable Media Manager	138
Log Data	138
Load and Save Applications	138
View and Capture Screens	139
Removable Media (RM) Function Blocks in Cscope	139
Filenames and Function Blocks	141
System Registers used with RM	141

microSD Cards

All XLE/XLT models provide a Removable Media slot, labeled Memory, which supports standard microSD memory cards. microSD cards can be used to save and load applications, to capture graphics screens and to log data for later retrieval.

microSD card



Flash memory (aka a thumb drive)



Format a microSD Card

1. Select Removable Media in the System Menu of the controller.
2. Place card in the “Memory” slot.
3. Final Step:
 - a. For XLE, press the bottom right soft key to get the submenu that includes “format”, select format.
 - b. For XLT, press the bottom left and right keys to get the sub menu that includes “format”, select format.

Install & Remove a microSD card

The XLE/XLT Memory slot is equipped with a “push-in, push-out” connector and a microSD card can be safely inserted into the Memory slot when the XLE/XLT is powered On or Off.

To install a microSD card: Align its 8-pin gold edge connector down, facing the front of the XLE/XLT unit as shown in Figure 15.1; then carefully push it all the way into the Memory slot. Ensure that it clicks into place.

To remove the microSD card: Push down on the top of the card gently to release the spring. The card pops up for removal.

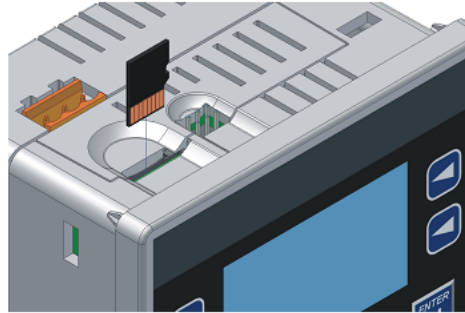

microSD File System

XLE/XLT prior to Rev TA supported the FAT16 file system which allows up to 2.0 GB of memory, while XLE/XLT with REV TA and higher support the FAT32 file system which allows up to 2TB of memory. FAT microSD cards are compatible in REV TA units and higher. The XLEe and XLTe also support the FAT32 file system.

This means that a PC, with a microSD-compatible card reader, can read files that have been written by the XLE/XLT and can write files that can be read by the XLE/XLT.

The XLE/XLT supports the 8.3 filename format. This means that all file and directory names must consist of up to eight (8) characters, followed by an optional dot, and an optional extension with up to three (3) characters.

Directories and sub-directories may be nested up to 16 levels deep as long as each pathname string does not exceed 147 characters.

The Removable Media Manager can be accessed via the System Menu or by using Cscape to place a Removable Media Manager object on an application graphics screen.

Using the Removable Media Manager

The Removable Media Manager is an interactive XLE/XLT screen that performs the following functions:

- Display number of total and free bytes
- Browse file and directory lists
- Delete files and directories
- Format a microSD card
- Load and save application programs
- View screen capture bitmaps

The Removable Media Manager can be accessed via the System Menu or by using Cscope to place a Removable Media Manager object on an application graphics screen.

Log Data

Using Read and Write Removable Media function blocks, an application ladder program can read and write XLE/XLT register data in the form of comma-delimited files, with a .csv extension. These files are compatible with standard database and spreadsheet PC programs. In addition, an application ladder program can use Rename and Delete Removable Media function blocks to rename and delete files.

Load and Save Applications

A special file type, with a .PGM extension, is used to store XLE/XLT application programs on microSD.

To load an application from microSD to the XLE/XLT, use the Removable Media Manager to find and highlight the desired .PGM file, and then press **Enter**.

To save an application from the XLE to microSD, open the Removable Media Manager in the System Menu and press the F4 function key. The application will be saved in a file called **DEFAULT.PGM** in the microSD root directory.

To save an application from the XLT to microSD, open the Removable Media Manager in System Menu and press the Save Pgm soft key displayed at the bottom of the XLT's touch screen. The application will be saved in a file called DEFAULT.PGM in the microSD root directory.

NOTE: Saving an application to microSD can only be done from the System Menu and is not available on a Removable Media Manager object that was placed on an application graphics screen by Cscope.

NOTE: Saving an application to microSD does not also save register data.

Cscope can also save an application directly to a microSD card, which is plugged into the PC's microSD compatible card reader by selecting the Export to Removable Media item on the File menu.

View and Capture Screens

The XLE/XLT File System uses bitmap files with the .BMP (.bmp) extension to store XLE/XLT graphic screen captures.

To view a captured XLE/XLT screen, use the Removable Media Manager to find and highlight the desired .BMP file, and then press Enter.

To capture an XLE/XLT screen, turning on the assigned Screen Capture Control Register will capture the current XLE/XLT graphics screen and write it to the microSD card using the assigned Screen Capture Filename.

Before capturing an XLE/XLT screen, Cscape must first be used to assign a Screen Capture Control Register and Filename in the application. To do this, first open the Graphics Editor by selecting the View / Edit Screens item on the Cscape Screens menu. Next, select the Screen Capture item of the Graphics Editor Config menu and then enter a Control Register and Filename.

Removable Media (RM) Function Blocks in Cscape

NOTE: For detailed information regarding RM function blocks and parameters, refer to the Help File in Cscape.

The following RM functional blocks are available in Cscape Software.

These function blocks will reference:

- a. microSD when filename is prefixed with 'A:' or nothing
- b. USB A Flash Drive when filename is prefixed with 'B:'

RM Function Blocks	
Read RM csv	Allows reading of a comma-separated value file from the microSD interface into the controller register space.
Write RM csv	Allows writing of a comma-separated value file to the microSD interface from the controller register space.
Rename RM csv	Allows renaming a file on the RM card. The data in the file is not changed.
Delete RM csv	Allows deleting a file on the RM card
Copy RM csv	Allows copying a file on the RM card. The data in the file is not changed.

Program Features

Datalog Configuration—This feature allows the controller to periodically log register values to Removable Media. The register data is stored in .csv (comma separated value) format, which is compatible with 3rd party PC applications, such as Microsoft Excel.

Report Editor—This feature allows the OCS to be configured to generate text printouts which incorporate data from the registers embedded in the text. The reports can be printed using a serial interface printer through any of the serial ports of the OCS or can be saved on the removable media of the device.

Graphic/Screen Editor

Trends—The historic support feature in the trend object utilizes Removable Media.

Removable Media—This is a graphic object used to access files and functions pertaining to Removable Media.

Recipes—This is a graphic object that is used in conjunction with the recipe editor which is mentioned above.

Additional Configuration

Alarms - Alarm data can be logged to a .csv file stored on Removable Media.

Screen Capture - The screen capture function allows a bitmap or jpeg image of the displayed OCS screen to be written to the Removable Media card.

Filename Counters - The filename counters can be accessed wherever Removable Media functions require a path name. A typical application is the auto-incrementing of a file name when doing screen captures.

File Select - File Select is used to specify the register block that is used with the Removable Media Manager object 'Write Selected Filename' option.

Filenames and Function Blocks

The RM function blocks support the flash with a Windows standard FAT-16 file system. All names must be limited to the “8.3” format where the filename contains eight characters a period then a three-character extension.

The entire filename including any path must be less than or equal to 147 characters.

When creating filenames and directories, it is sometimes desirable to include parts of the current date or time. There are six special symbols that can be entered into a filename that are replaced by the OCS with current time and date information.

Filename Special Symbols		
Symbol	Description	Example
\$Y	Substitutes the current 2-digit year	2022 = 22
\$M	Substitutes the current month with a 2-digit code	March = 03
\$D	Substitutes the current day	22nd = 22
\$h	Substitutes the current hour in 24-hour format	5 pm = 17
\$m	Substitutes the current minute	45 = 45
\$s	Substitutes the current second	34 = 34

NOTE: All the symbols start with the dollar sign (\$) character. Date symbols are in upper case, time symbols are in lower case.

The following are examples of the substituted time/date filenames:

Current date and time: March 1, 2022 5:45:34 PM

Filename: Data\$M\$D.csv = Data0301.csv

Filename: Year\$Y\Month\$M\aa\$D_\$h.csv = Year22\Month03\aa01_17.csv

Filename: Month_\$M\Day_\$D\h_\$m_\$s.csv = Month_03\Day_01\17_45_34.csv

System Registers used with RM

%SR174 – Removable Media Protect. Write a one (1) to %SR174 to prohibit read/write access to the removable media card. Write a zero (0) to allow access.

%SR175 Status – This shows the current status of the RM interface.

%SR176 Free Space – This 32-bit register shows the free space on the RM card in bytes.

%SR178 Card Capacity – This 32-bit register shows the total card capacity in kilobytes.

Possible status values are shown in the table:

RM Status Values	
0	RM interface OK
1	Card present but unknown format
2	No card in slot
3	Card present, but not supported
4	Card swapped before operation was complete
5	Unknown error

Clone Unit



Clone Unit

Clone	143
Load Clone	146

The 'Clone Unit' feature allows the user to "clone" the OCS of the exact same model. This feature "clones" application program and unit settings stored in Battery backed RAM of an OCS into the RM. Refer to "Removable Media" on page 136 for more details on using RM. It can then be used to clone a different OCS (same model).

This feature can be used for:

- Replacing an OCS by another unit of the same model.
- Duplicating or "clone" units without a PC.

Clone

User must perform the following sequence of action to Clone a unit:

Step 1: The 'Clone Unit' can be accessed by going to the 'System Menu' of the OCS. A new menu "Clone Unit" has been added at the end of the main system menu as shown below:

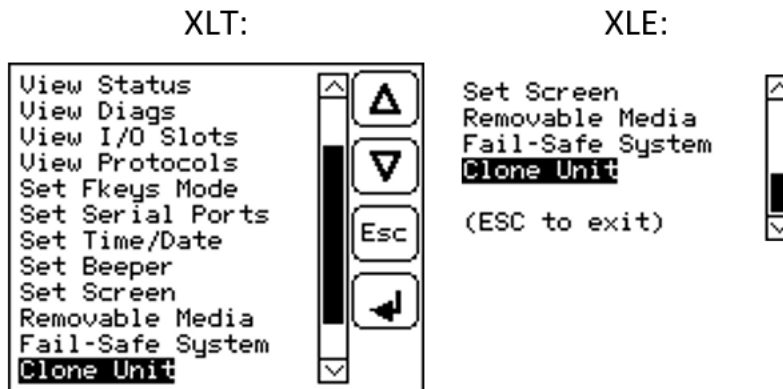

Step 2: Selecting “Clone Unit” menu will open the following menu screen:

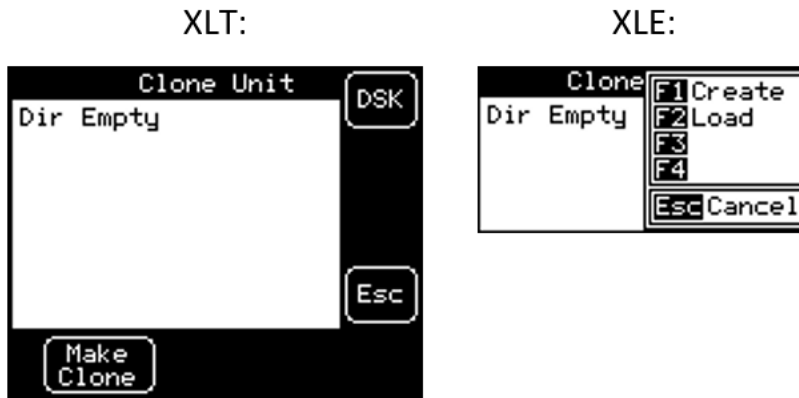

NOTE:

- a. In the above figure, F3 and F4 are inactive in the Clone Unit.
- b. **DSK** – when selected shows the number of total and free bytes in Removable Media.

Step 3 - Make/Create Clone option enables the user to duplicate / Clone an application file, all unit settings and all register values from Battery Backed RAM. Selecting Make Clone brings up the screen below:

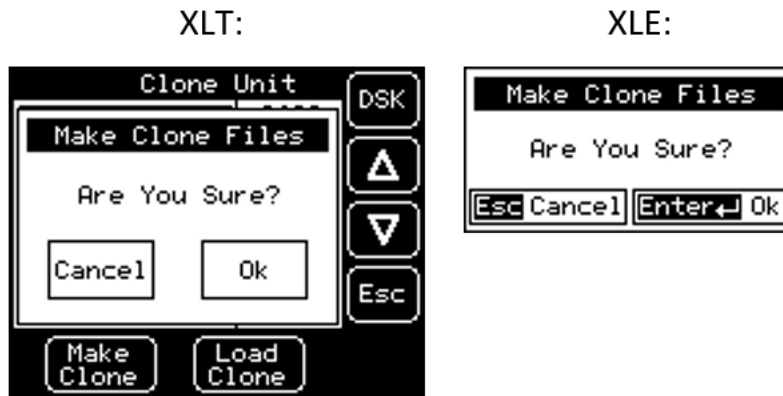

After confirmation, the OCS will create two new files in the root directory of the Removable Media Drive as shown below:

AUTOLOAD.PGM - Application file

CLONE.DAT - File having all unit settings and register values from Battery Backed RAM

XLT:

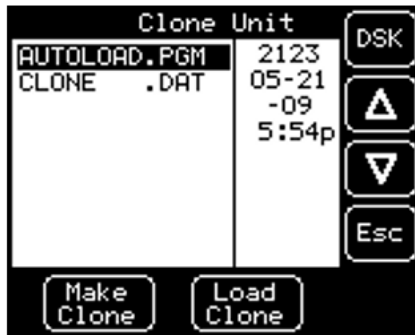

XLE:

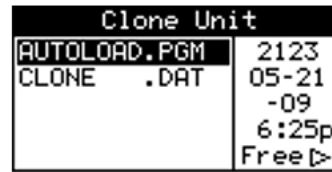

NOTE: Make/Create clone operation automatically includes the security in AUTOLOAD.PGM file for security enabled files.

Step 4: Once the cloning is successful, the OCS gives a message as below:

XLT:

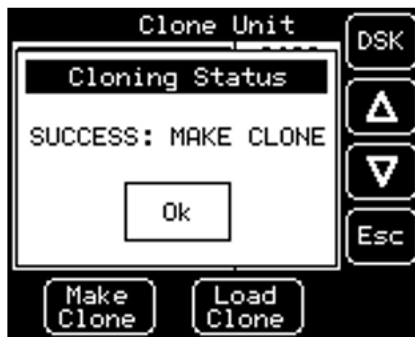

XLE:

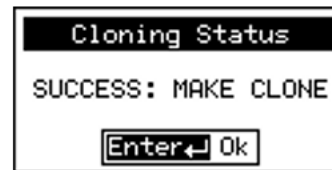

Make/Create clone can also be triggered by setting %SR164.9 bit to “1” from Ladder program or graphics. Once the operation is completed, this bit is made zero by the firmware. When Make clone operation is triggered by this SR bit, it does not ask the user for confirmation to make the clone. The success / failure of the operation is also not notified on screen to the user.

In case of failure of “Make Clone” operation, %SR164.11 bit is set to “1” by the firmware and never reset.

NOTE: Backup of registers in flash memory is not performed by the Clone Feature. If user desires, Backup should be done as explained in the Fail-Safe System chapter.

Load Clone

This option loads the application, all unit settings and register values from Removable media to the Battery backed RAM (Regardless of AutoLoad settings) and then resets the OCS for the settings to take effect.

User must perform the following to Load the Clone:

Step 1: Select "Clone Unit" from main system menu of OCS as shown below:

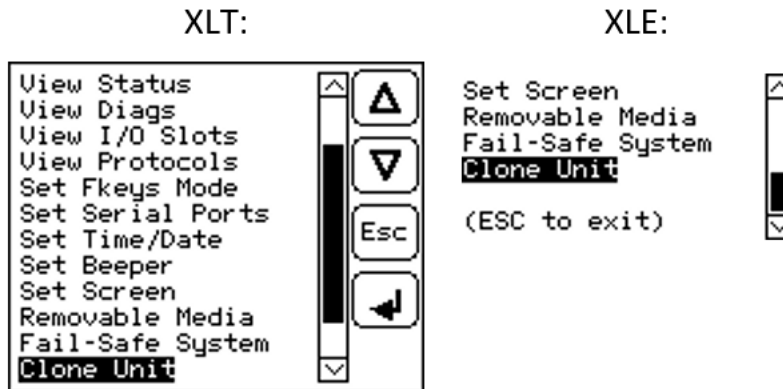

Selecting "Clone Unit" menu will open the following menu screen. Select "Load Clone".

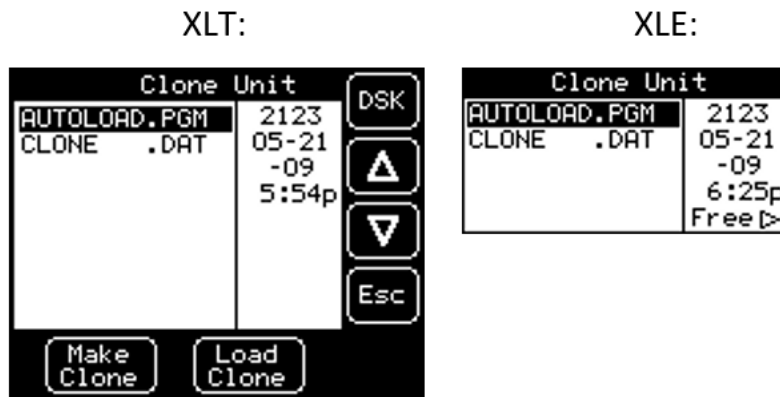

Step 2: User must confirm Load Clone as shown below:

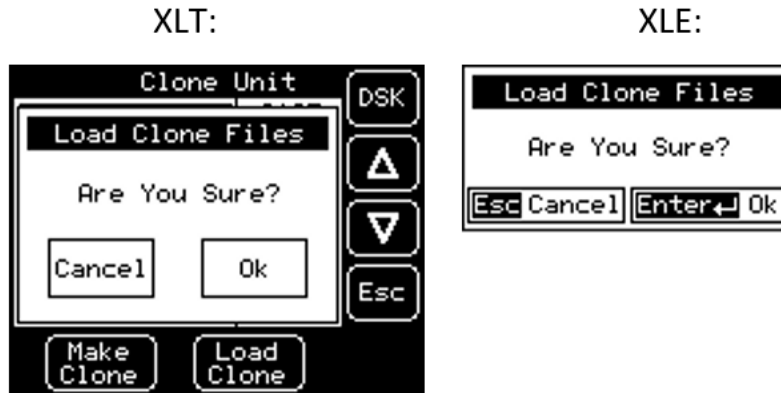

Step 3: After confirmation, all unit settings and register values will be loaded from the Removable media to the Battery backed RAM (Regardless of AutoLoad settings) and then the OCS resets at which stage the settings take effect.

NOTE: For security enabled files, Load clone asks for password validation before loading the application.

Load clone can also be triggered by setting %SR164.10 bit to “1” from Ladder program or graphics. Once the operation is completed, this bit is made zero by the firmware. When the Load clone operation is triggered by this SR bit, it does not ask the user for confirmation to load the clone. The success / failure of the operation is not notified on the screen to the user.

In case of failure of the “Load Clone” operation, %SR164.12 bit is set to “1” by the firmware and never reset.

Fail-Safe System



Fail-Safe System

Fail-Safe Features	149
Settings	150
Backup / Restore Data	150
Flow Chart for Automatic Restore	152
AutoLoad	153
AutoRun	155

Fail-Safe Features

The Fail-Safe System is a set of features that allows an application to continue running in the event of certain types of "soft" failures. These "soft" failures include:

- Battery power loss
- Battery-Backed Register RAM or Application Flash corruption due to, for example, an excessive EMI, Electromagnetic Interference, event.

The Fail-Safe System has the following capabilities:

- Manually backup the current Battery-Backed RAM Register Settings into Flash memory.
- Manually restore Register Settings from the values previously backed up in Flash to Battery-Backed RAM.
- Detect corrupted Register Settings at power-up and then automatically restore them from Flash.
- Detect corrupted or empty application in Flash memory at power-up and then automatically load the AUTOLOAD.PGM application file from Removable Media (Compact Flash or microSD).
- If an automatic Register Restore or Application Load occurs, the OCS can automatically be placed in RUN mode

The fail-safe system can be accessed through the system menu of the controller. A new menu "Fail-Safe System" has been added at the end of the main system menu for this. Selecting "Fail-Safe System" menu will open the following menu screen:

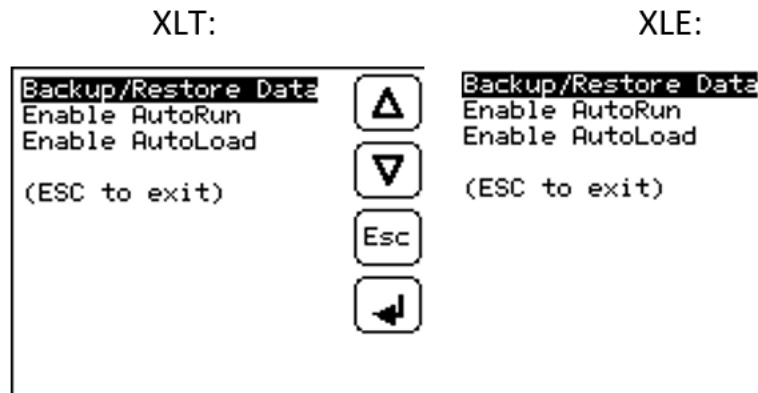

Settings

To use the Fail – Safe feature, the user must do the following:

1. From Cscape, create AUTOLOAD.PGM for the application program using 'Export to Removable Media'.
2. Place the Removable Media with AUTOLOAD.PGM in the device.
3. Set the 'Enable AutoLoad' option in the device to YES.
4. Set the 'Enable AutoRun' option to YES if the controller needs to be placed in RUN mode automatically after automatic restore of data or AutoLoad operation.
5. Backup the current Battery-Backed RAM Register contents in On-Board Flash memory using System Menu options.

Backup / Restore Data

Selecting this option brings up a screen having four operations:

- Backup OCS Data.
- Restore OCS Data.
- Clear Backup Data.
- Exit

XLT:

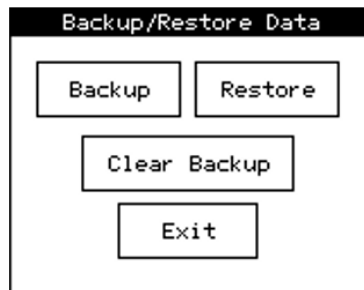

XLE:



Backup OCS Data

When initiated, this will allow the user to manually copy Battery-Backed RAM contents on to the onboard FLASH memory of the OCS. This will have the effect of backing up all the registers and controller settings (Network ID, etc.) that would otherwise be lost due to a battery failure. %SR164.4 is set to 1 when backup operation is performed.

XLT:



XLE:



Restore OCS Data

When initiated, this will allow the user to manually copy the backed-up data from the onboard FLASH to the Battery-Backed RAM.

A restore operation will be automatically initiated if a backup has been previously created and on power-up the Battery-Backed RAM registers fail their check.

The following process is implemented to restore data:

1. The controller will be placed in IDLE mode.
2. Data will be copied from onboard FLASH to OCS Battery-Backed RAM
3. The controller will reset.
4. The controller will be put in RUN mode if the AutoRun setting is 'Yes' else it will remain in IDLE mode.

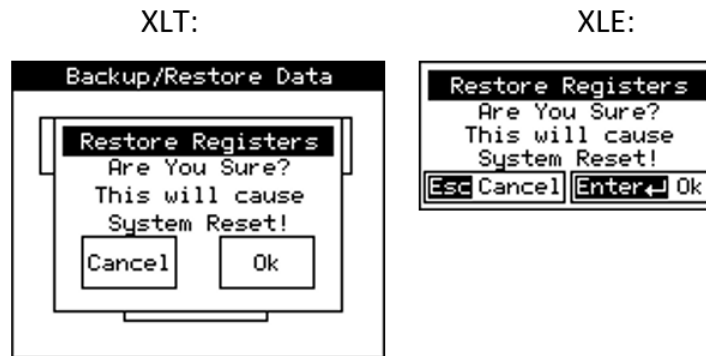

%SR164.3 is set to 1 only when an automatic restore operation is performed - not on a manual one. This bit is reset to the value of 0 when a new backup is created.

Restoring of data can be manually performed by selecting RESTORE option from the Backup / Restore Data menu. This will cause the controller to reset.

Clear Backup Data

When initiated, the backup data will be erased from the onboard Flash and no backup will exist. %SR164.4 and %SR164.3 is reset to the value of 0 when backed up data is erased.

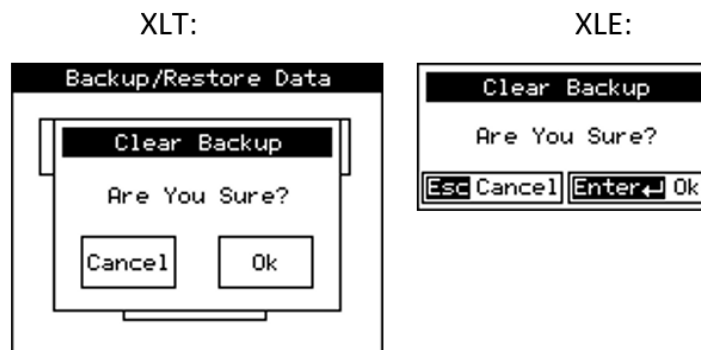

Exit: Goes back to the previous screen.

Flow Chart for Automatic Restore

The OCS follows the following sequence in execution of Automatic Restore:

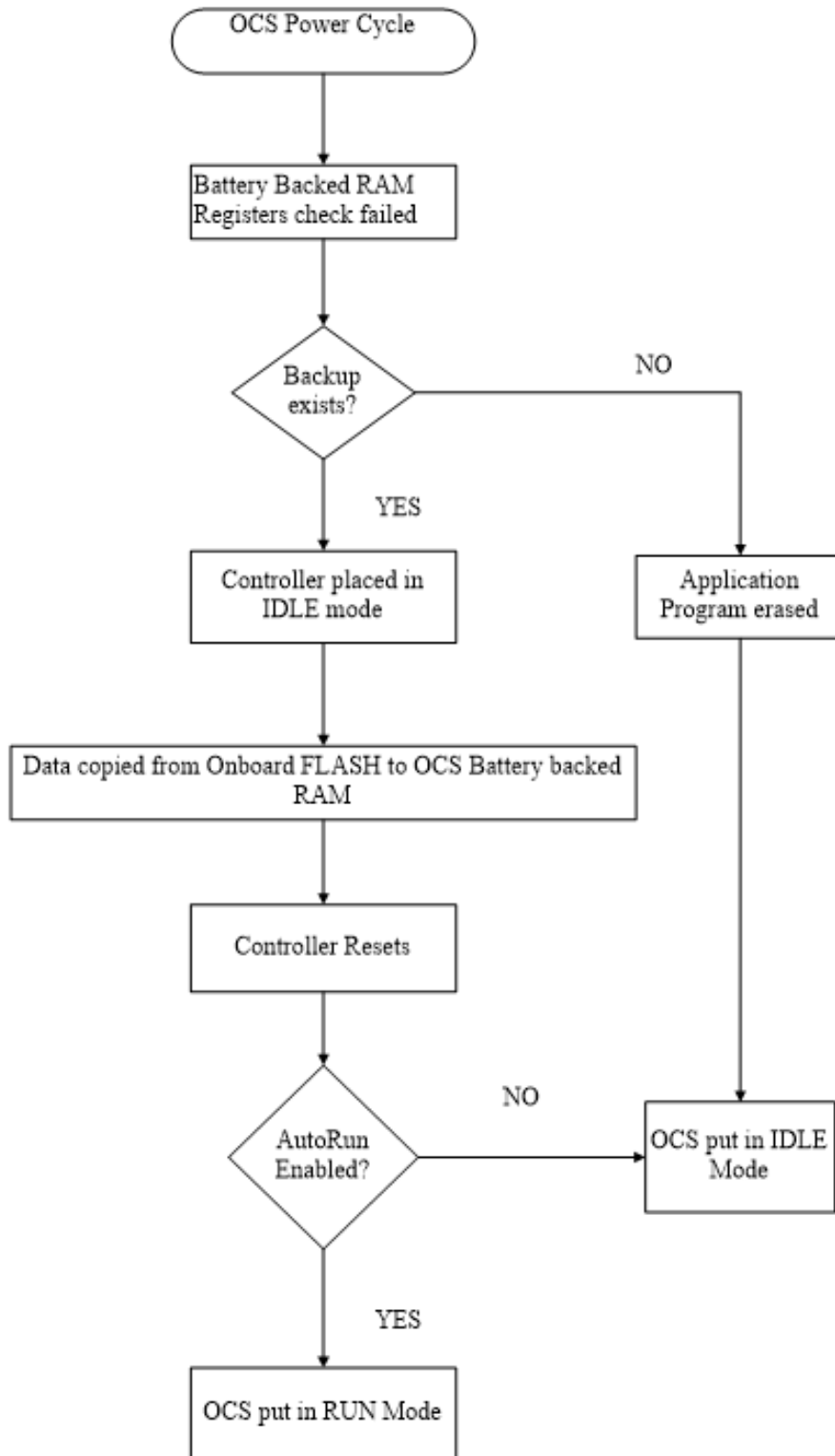

AutoLoad

This system menu option allows the user to specify whether the OCS automatically loads the application AUTOLOAD.PGM located in Removable Media.

When the AutoLoad setting is enabled (set to YES), it can be manually or automatically initiated at power-up.

The automatic initiation will happen only in the following two cases:

- When there is no application program in the OCS and a valid AUTOLOAD.PGM is available in the removable media of the device.
- When the program residing in onboard memory is corrupted and a valid AUTOLOAD.PGM is available in the removable media of the device.

AutoLoad can be manually initiated when the SYS-F3 key is pressed (OCS can be in any of the following mode – Idle / Run / DOIO). This also requires a valid AUTOLOAD.PGM to be present in the removable media of the device.

When the AutoLoad setting is not enabled (set to NO), OCS will be in IDLE mode and the application is not loaded.

If the AUTOLOAD.PGM is security enabled, the user will be prompted to enter the password before loading the application. The application will be loaded from the Removable media only after getting the correct password.

%SR164.6 can be set to enable AutoLoad feature.

XLT:

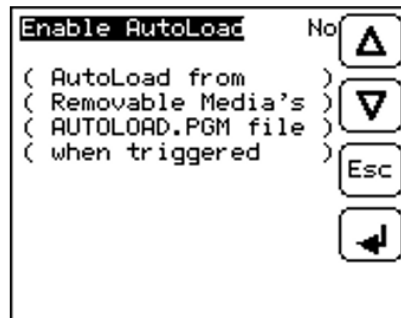

XLE:



The OCS implements the following sequence to execute the AutoLoad function:

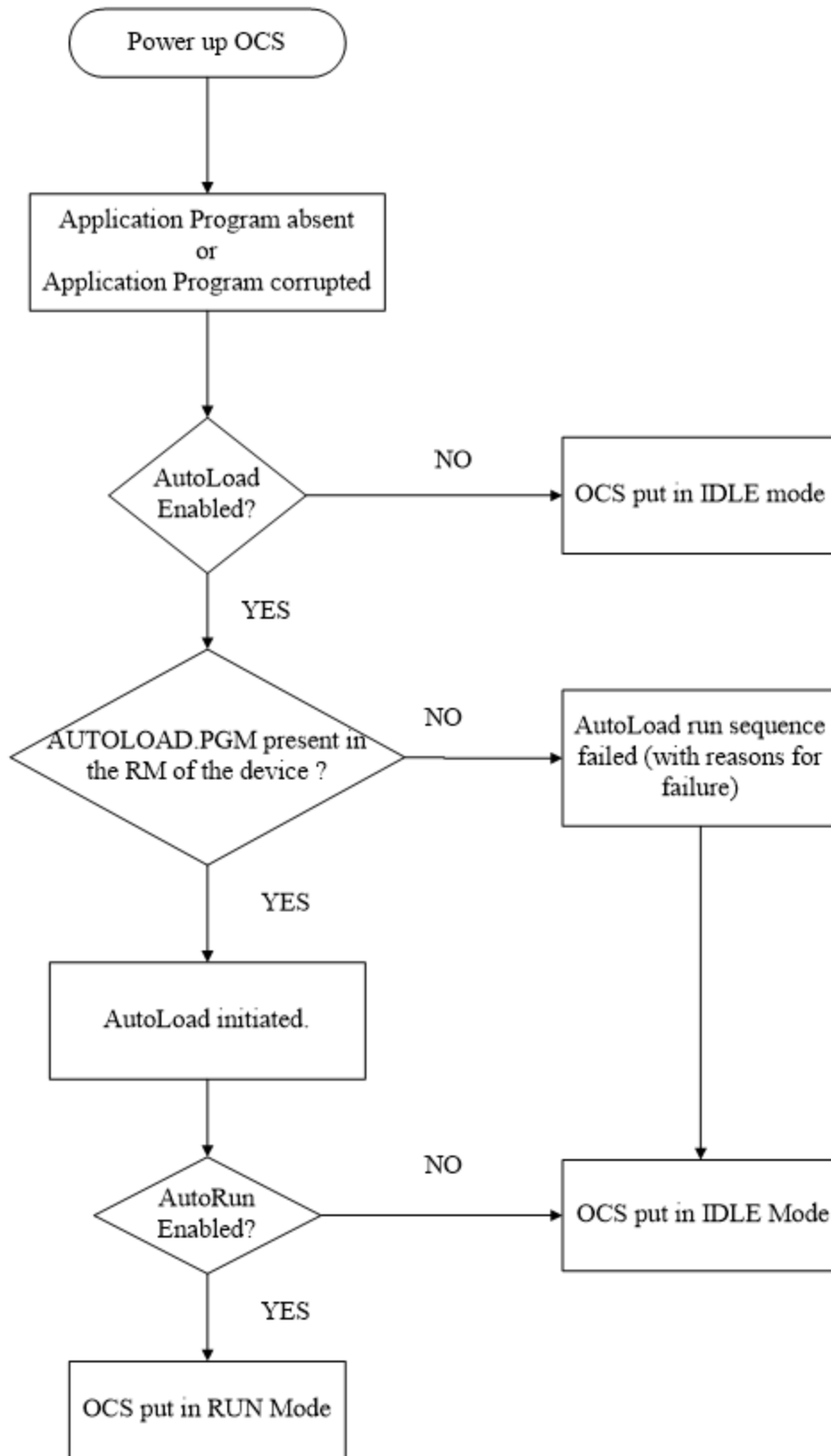

AutoRun

This system menu option, when enabled (YES), allows the user to automatically place the OCS into RUN mode after the AutoLoad operation or automatic Restore Data operation.

When the AutoRun setting is disabled (NO), the OCS remains in the IDLE mode after a Restore Data or AutoLoad operation.

%SR164.5 can be set by putting the system into RUN mode automatically, once an AutoLoad has been performed or an Automatic Restore has occurred.

If for any reason the AutoLoad-Run (Loading the AUTOLOAD.PGM automatically and OCS put in RUN mode) sequence does not succeed, a pop-up message box saying "AUTO-LOAD-RUN SEQUENCE FAILED" will be displayed. It will also show the reason for its failure. On acknowledging this message box the AutoLoad-Run sequence will be terminated, controller will return to the first user-screen and will be placed in IDLE mode.

XLT:

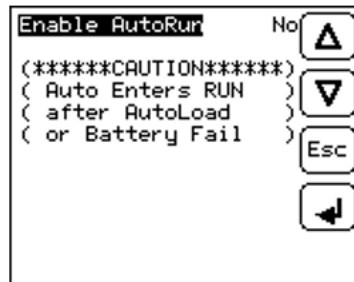

XLE:

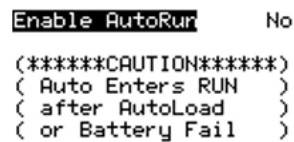

Modbus Communications



Modbus Communications

Modbus Slave	157
Modbus Master	158
Modbus Addressing Tables for XLE/XLT Units	159

Modbus Overview

For complete Modbus instructions, please refer to the Help file in Cscape.

Modbus (serial) is a popular, de-facto standard protocol that allows industrial devices from multiple manufacturers to easily share data in real-time. For Modbus serial communications, the XLE/XLT can act as either a Master or a Slave.

Modbus protocol (serial) allows for one master and multiple slaves. The master always initiates the conversation by sending a request to a particular slave. Only the addressed slave will send a response when the request is completed. Should the slave be unable to complete the request, it returns the appropriate error response. Should the slave be unable to respond, the master's timeout timer expires to provide an indication of No Response.

Modbus Slave

For complete Modbus Slave instructions, please refer to the Help file in Cscape.

The Modbus slave function block, when used with the appropriate Modem and/or Open function blocks, allows the primary serial port on the controller to act as a Modbus slave. The Modbus function supports both ASCII and RTU modes of operation across a range of baud rates and protocol frames. Also supported is port activity status, an inactivity timer, support for call-on exception, and support for store and forward (repeater) operation for radio modems.

The Modbus Addressing section describes the supported Modbus Commands as well as the Modbus Map for XLE/XLT References (%R, %M, etc.).

Modbus Master

For complete Modbus Master instructions, please refer to the Help file in Cscape.

When acting as a Modbus master, there are two primary mechanisms used by the XLE/XLT to allow the user to specify the data to be read/written from/to the slaves.

Modbus Master Function Block—This is for serial only. This is an advanced feature that should only be used in rare occasions.

Protocol Config—The Protocol Config is configured in the Hardware Configuration dialog box in Cscape (serial)

This is the preferred method in most applications.

After the protocol has been selected from the dropdown menu, the **Network**, **Devices**, and **Scan List** become available. The Protocol Config is configured on three different levels:

- **Network**—Parameters, such as the polling rate of the data scan, are specified along with timeout values, retry, and re-acquisition settings. Serial configuration, baud rate, parity, etc. are also set here.
- **Devices**—For every slave to be polled, configuration details are added in the Devices dialog box. This includes Slave ID (serial). Under Device Type, the Modbus addressing style matching that specified in the slave's user documentation may be selected. For instance, some slaves specify Modbus addresses (i.e. 40,001), and others specify offsets (i.e. 0000).
 - **Hex or Decimal**—Some specify addresses in hex, and others in decimal. By allowing the user to select the Modbus addressing style for each slave on the network, minimal address conversion is required. Also, if the slave is another Horner product (i.e. another OCS), the "Native Addressing" option can be selected (i.e. %R1, %M17, etc.), and this skips the conversion to Modbus style altogether.
- **Scan List**—This is where the specific Modbus addresses to be read/written from/to each slave are specified. Up to 32 words of data can be read at the same time.

NOTE: Once configuration has been completed on the Network and Devices level, Modbus data can be directly read/written from graphics objects in the Cscape screen editor. This is available even if the Modbus register is not listed on the scan list.

The above information is just an introduction to the topic. For more detailed information, please consult the Cscape Help file.

Modbus Addressing Tables for XLE/XLT Units

To access XLE/XLT registers, a Modbus Master must be configured with the appropriate register type and offset. This is usually accomplished with one of two methods:

Method 1: The first method uses **Traditional Modbus References**, in which the high digit represents the register type and the lower digits represent the register offset (starting with Register 1 for each type). Since only four register types can be represented in this manner, XLE/XLT Modbus Function Blocks pack several XLE/XLT register types into each Modbus register type. Starting addresses of each XLE/XLT register type are shown in the Traditional Modbus Reference column of the tables below.

Method 2: The second method requires the Modbus Master to be configured with a specific **Modbus Command** and **Modbus Offset**. The supported Modbus commands and the associated offsets are also illustrated in the tables below.

XLE/ XLEe Modbus Master Mapping					
XLE/XLEe Reference	Maximum Range	Trad. Modbus Reference (5 Digits)	Expanded Modbus Ref. (6 Digits)	Modbus Command(s)	Modbus Offset
%I1	2048	10001	010001	Read Input Status (2)	0
%IG1	64	13001	013001		3000
%S1	13	14001	014001		4000
%K1	10	15001	015001		5000
<hr/>					
%Q1	2048	00001	000001	Read Coil Status (1) Force Coil (5) Force Multiple Coils (15)	0
%M1	2048	03001	003001		3000
%T1	2048	06001	006001		6000
%QG1	64	09001	009001		9000
<hr/>					
%AI1	512	30001	030001	Read Input Register (4)	0
%AIG1	32	33001	033001		3000
%SR1	192	34001	034001		4000
<hr/>					
%AQ1	512	40001	040001	Read Holding Register (3) Load Register (6) Load Multiple Registers (16)	0
%R1	2488	40513	040513		512
%R1	2048	43001	043001		3000
%AQQ1	32	46001	046001		6000
%R1	9999	--	410001		10000

XLT/ XLTe Modbus Master Mapping					
XLT/XLTe Reference	Maximum Range	Trad. Modbus Ref. (5 Digits)	Expanded Modbus Ref. (6 Digits)	Modbus Command(s)	Modbus Offset
%I1	2048	10001	10001	Read Input Status (2)	0
%IG1	64	13001	13001		3000
%S1	13	14001	14001		4000
%K1	4	15001	15001		5000
%Q1	2048	00001	000001	Read Coil Status (1) Force Coil (5) Force Multiple Coils (15)	0
%M1	2048	03001	003001		3000
%T1	2048	06001	006001		6000
%QG1	64	09001	009001		9000
%AI1	512	30001	030001	Read Input Register (4)	0
%AIG1	32	33001	033001		3000
%SR1	192	34001	034001		4000
%AQ1	512	40001	040001	Read Holding Register (3) Load Register (6) Load Multiple Registers (16)	0
%R1	2488	40513	040513		512
%R1	2048	43001	043001		3000
%AQG1	32	46001	046001		6000
%R1	9999	--	410001		10000

Backup Battery



Backup Battery

Precautions & Safety	162
Steps for Battery Replacement	163

Precautions & Safety

The XLE/XLT contains an internal lithium battery that is used while power is disconnected for the following functions:

- Run the real-time clock
- Maintain retentive registers
- Maintain the application program

Under normal conditions the battery in the XLE/XLT should last seven (7) to ten (10) years. Higher operating temperatures or variations in batteries may reduce this time.

Preventing Program Loss: An available option to prevent the loss of program should the battery be drained is to use the Backup/Restore function which is part of the Fail-Safe System.

This feature is highly recommended and is accessible from the System Menu and from program logic.

Backup/Restore DOES NOT require the installation of a microSD card in order to prevent program loss. Refer to "Fail-Safe System" on page 149 for complete details.

The battery will generally last seven (7) to ten (10) years. Environmental conditions, including extreme temperatures and humidity, can affect battery life. If the battery is older than seven (7) to ten (10) years old, it is recommended that it be replaced as preventative maintenance.

WARNING: DO NOT USE IF BATTERY IS LEAKING OR HAS BEEN DAMAGED.

WARNING: LITHIUM BATTERIES MAY EXPLODE OR CATCH FIRE IF MISTREATED. DO NOT RECHARGE, DISASSEMBLE, HEAT ABOVE 100° C (212° F) INCINERATE, OR PUNCTURE.

WARNING: EXPLOSION HAZARD – BATTERIES MUST BE ONLY BE CHANGED IN A AREA KNOWN TO BE NON-HAZARDOUS.

WARNING: Disposal of lithium batteries must be done in accordance with federal, state, and local regulations. Be sure to consult with the appropriate regulatory agencies before disposing batteries. In addition, do not recharge, disassemble, heat or incinerate lithium batteries.

WARNING: Do not make substitutions for the battery. Be sure to only use the authorized part number to replace the battery.

NOTE: The XLE/XLT uses a 3V coin lithium battery, part no. HE-BAT009 available from Horner Automation.

Steps for Battery Replacement

Below are the steps to replace the battery:

1. Make sure the user program and any data stored in retentive memory is backed up.
2. Disconnect all power from the XLE/XLT unit including I/O power.
3. Using a Phillips screwdriver, remove the four (4) screws on the back of the XLE/XLT unit by turning the four (4) corner screws counterclockwise. Remove the back cover.
4. Carefully remove the I/O board (if present) by lifting it straight up.
5. Remove the old battery. It may require a small flat blade screwdriver to lift it from the holder.
6. Dispose of the battery properly; see the above warning on disposal regulations.
7. Slide the new battery into the holder. Make sure the battery is inserted with the proper polarity. The top tab of the battery holder should contact the positive (+) terminal of the battery.
8. Replace the I/O circuit board by aligning the edges with the guideposts. Align the I/O board bus connector to bus pins, and then gently press on the I/O circuit board until it is seated.
9. Place the back cover back on the unit.
10. Place the screw back into the hole and turn the screw slowly counterclockwise until “clicks” into the threads. This will prevent the screw from being cross threaded. Now turn the screw clockwise until the cover is firmly secured. Repeat this process for all four (4) screws. Recommended torque is 3 - 4 in-lbs (0.34 – 0.45 Nm).

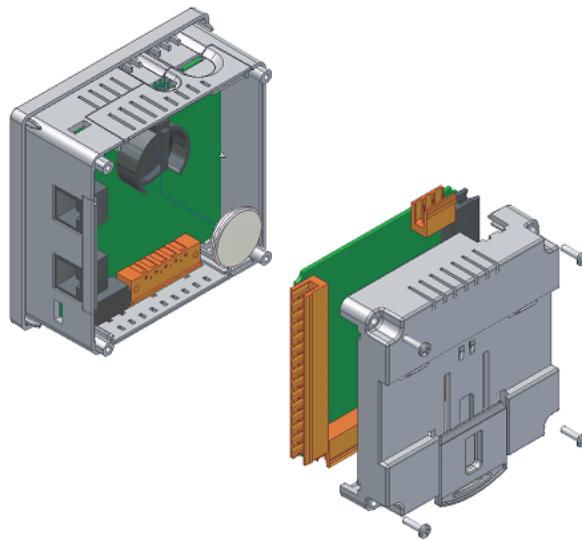

Firmware Update



Firmware Update

Firmware Update Details	165
Download Firmware	166
Update Firmware Steps	166
Firmware Update via microSD card	167
Manual Firmware Update via %SR's	168
Auto firmware update via %SR's	168

The XLE/XLT products contain field updatable firmware to allow new features to be added to the product at a later time. Firmware updates should only be performed when a new feature or correction is required. This applies to Generation 2 modules. For legacy modules please refer to the Firmware Update Manual using Horner's [Documentation Search](#) page.

WARNING: Firmware updates are only performed when the equipment being controlled by the XLE/XLT is in a safe, non-operation state. Communication or hardware failures during the firmware update process can cause the controller to behave erratically resulting in injury or equipment damage. Ensure the functions of the equipment work properly after a firmware update before returning the device to an operational mode.

Firmware Update Details

Check for Current Firmware Revision - To check the firmware revision on a controller, open **System Menu > View Status**.

NOTE: Updating firmware will clear the application program, screens, configurations, and register data. If required, make sure to backup program and register data before updating firmware. The controller's User Manual has instructions for doing backups.

There are various methods for updating firmware. The method used depends on the type of controller being updated.

Method A: Removable Media Method

The controller firmware is updated by a bootloader, using a microSD card or USB Flash drive (not through the Cscape Firmware Update Wizard). To update or change firmware:

1. Download desired Firmware set from the Horner APG website. (Verify CsCAN or CANopen communications.)
2. Save Firmware files to microSD card or USB, these are the removable media devices.
3. Update the firmware through the controller's Firmware Update function

NOTE: Files from the Horner website come as a .ZIP file which need to be unzipped and placed in the root of the drive for them to function properly.

Method B: RS232 Serial Connection

Serial firmware updates are done from Cscape software to the controller's primary serial port, MJ1 in most cases.

Method C: Mini USB Port – The mini USB port can be used to update firmware in the XLE and XLT series. This is quicker than doing so via MJ1.

Download Firmware

- a. In **North America**, visit <https://hornerautomation.com> Then click **Support > Downloads > Controller Firmware** and download the most recent firmware set with the correct communication protocol.
- b. In **Europe**, visit <http://www.hornerautomation.eu> and click **Support > Firmware** tab and download the desired firmware (an account is required to access firmware updates, create one if necessary).

Update Firmware Steps

1. Establish communication between Cscape and the controller using a direct serial connection to MJ1.
2. Make sure your application is available on your PC or upload the application.
3. Make sure the machinery connected to the XLE/XLT is in a safe state for firmware update (see warning above).
4. Start the firmware update by selecting **File > Firmware Update Wizard**.
5. The correct product type should be selected, if it is not select the type of controller from the drop-down list.
6. Press the **Start** button.
7. Wait for the firmware update to complete.
8. If there is a communication failure check the cable, connections and comm. port setting and try again.
9. Firmware updates typically delete the user applications to ensure compatibility. You will need to reload your application.
10. Test the operation of the equipment with the new firmware before returning the XLE/XLT system to an operation mode.

Firmware Update via microSD card

NOTE: Applies to XLEe and XLTe (ethernet models) only.

Method 1

Placing “.s19” file in the root of microSD card and loading firmware manually and automatically.

Manual firmware update by selecting “.s19” file - Place “.s19” file in the root of microSD card and insert the card. Go to System menu | Removable media and select “.s19” file that needs to be loaded. Device displays the following message “Do not power Cycle Until FW is updated”, select OK. Firmware update will be started, and a busy symbol will be displayed on the device until firmware will be loaded.

When firmware update will start %SR154.16 bit will be set to high. Once firmware update is completed %SR154.16 bits will be set to low.

Set %SR154.12 bit to high before selecting “.s19” file / before loading firmware if user program and register data should be cleared after the update.

Set %SR154.12 bit to low before selecting “.s19” file / before loading firmware if user program should be present, register values should be retained and status of the device needs to be retained after the update.

Auto firmware update via %SR's - Place “.s19” file in the root of microSD card and insert the card. When %SR154.9 is set to high, %SR154.16 bit goes high and controller will update the firmware which is placed in the root directory of SD Card. Once firmware update process is successful, %SR154.9 and %SR154.16 bits are reset (goes low).

NOTE: There will be no busy symbol indication for this method. User should monitor %SR's for the updates.

Set %SR154.12 bit to high if user program and register data should be cleared after the firmware update.

Set %SR154.12 bit to low if user program should be present, register values should be retained and status of the device needs to be retained after the firmware update.

Method 2

Placing “.s19” file in “Update” folder and loading firmware manually and automatically. For this test, user should create a folder “/Update/Vxyyzzz” folder in microSD card and then place the “.s19” files inside respective folders.

For example - “update/Vxyyzzz/ xlee.s19” (Where, V is for version and xxyyzzz is the version number, Vxyyzzz = V1549206). Screenshot of the directory structure that should be in microSD card:

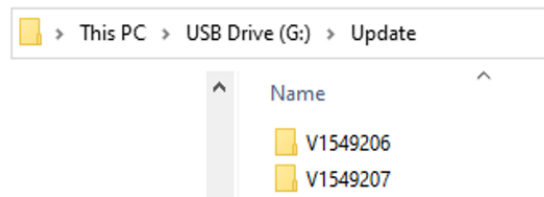

NOTES:

- If FW version on the device and firmware version inside Update folders are same, then nothing should happen.
- If multiple firmware version folders are available in the update directory, then the version that is greatest / latest should get updated to device.

Manual Firmware Update via %SR's

With proper folder structure placed in microSD card, insert the card to device.

Set %SR154.10 high. If firmware version folder inside update directory is greater than the firmware version on the device, then %SR154.16 will go high indicating firmware update process have started. Once firmware update process will be completed, %SR154.10 and %SR154.16 bits goes low.

NOTE: There will be no busy symbol indication for this method. User should monitor %SR's for the updates.

Set %SR154.12 bit to high if user program and register data should be cleared after the update.

Set %SR154.12 bit to low if user program should be present, register values should be retained and status of the device needs to be retained after the update.

Auto firmware update via %SR's

Setting %SR154.10 and %SR154.11 high, whenever new firmware folder is placed in the microSD card, firmware update will happen automatically setting %SR154.16 bit high. Once firmware update process will be completed, %SR154.16 bit will be reset but %SR154.10 and %SR154.11 will remain high (for auto update of firmware).

NOTE: There will be no busy symbol indication for this method. User should monitor %SR's for the updates.

Set %SR154.12 bit to high if user program and register data should be cleared after the update.

Set %SR154.12 bit to low if user program should be present, register values should be retained and status of the device needs to be retained after the update.

In all the methods, device will reset automatically after firmware update process is completed.

Troubleshooting & Tech Support



Troubleshooting

Connecting to the XLE/XLT	170
Local Controller and Local I/O	171
CsCAN Network	172
Removable Media Troubleshooting	173
Technical Support Contacts	173

Connecting to the XLE/XLT

Cscape connects to the local controller automatically when the serial connection is made. The status bar below shows an example of a successful connection. This status bar is located in the bottom right hand corner of the Cscape window.

Local 253 Target:253(R) [no forces]

In general, the **Target** number should match the Local number. The exception to this is when the controller is being used as a "pass through" unit where other controllers on a CsCAN network could be accessed through the local controller.

Determine connection status by examining feedback next to Local & Target in the status bar of Cscape.

Connecting to the XLE/XLT	
Local: ###	If a number shows next to Local then communication is established to the local controller.
Local: No Port	Cscape is unable to access the COM port of the PC. This could mean that Cscape is configured for a COM port that is not present or that another program has control of the COM port. Only one Cscape window can access a port at a time. Subsequent instances of Cscape opened will indicate No Port.
Local: No Com	Cscape has accessed a PC COM port, but is not communicating with the controller. This typically occurs when the controller is not physically connected.
Local: ???	Unknown communication error. Close Cscape, power cycle the controller and reopen Cscape with a blank project. Check Local.
Target: #(I,R,D)	If I (idle), R (run), or D (do I/O) shows next to Target number, then communication is established to the target controller.
Target: #(?)	Communication is not established to the target controller. Check node ID of controller and set Target to match. Make sure local connection is established.

Connecting Troubleshooting Checklist

1. Programming and debugging can use MJ2 if it is set as the default programming port.
2. Controller must be powered up.
3. Assure that the correct COM port is selected in Cscape.
4. **Tools > Application Settings > Communications** .
5. Check that a Loaded Protocol or ladder is not actively using MJ1/MJ2. Taking the controller out of run mode from the System Menu on the controller will make MJ1/MJ2 available to Cscape.
6. Make sure the COM port of the PC is functioning. An RS-232 serial loopback and Microsoft HyperTerminal can determine positively if the COM port is working. Or connect to an alternate device to determine if the port is working.
7. Successful communications with USB-to-serial adapters vary. If in doubt, Horner Automation offers a USB to serial adapter. Part number: HE-XCK.
8. XLE/XLT units with built-in Ethernet or installed HE-XEC module can be programmed and debugged via the Ethernet port. If the HE-XEC is installed, it can be selected as the programming port. The selection is made in the controller's System Menu under the Serial Port settings. If there are difficulties connecting, make sure that the default programming port is set correctly with the connection method being attempted.

Local Controller and Local I/O

The System Menu provides the following status indications that are useful for troubleshooting and system maintenance.

- Self-test results, diagnostics.
- RUN and OK status
- Network status and usage
- Average logic scan rate
- Application memory usage
- Loaded firmware versions
- Loaded protocols
- Removable media access

To view the system menu, press the UP and DOWN arrow keys simultaneously. Refer to the "System Settings" on page 24 for full details on the System Menu diagnostic capabilities.

Local I/O Troubleshooting Checklist

1. Verify the controller is in RUN mode.
2. Check diagnostics to ensure controller passed self-tests.
3. View Diags in System Menu or in Cscape, click: Controller > Diagnostics
4. Check data sheets to ensure proper wiring.
5. Ensure that hardware jumpers and software configuration for I/O match.
6. Check data sheets for voltage and current limits.
7. Take ladder out of the picture. From Cscape set controller to "Do I/O" mode. In this mode inputs can be monitored, and outputs set from a data watch window in Cscape without interference from the ladder program. Some I/O problems are only a result of a mistake in the ladder program.

WARNING: Setting outputs ON in Do I/O mode can result in injury or cause machinery to engage in an unsafe manner depending on the application and the environment.

CsCAN Network

For complete information on setting up a CsCAN network, refer to CAN Networks manual ([MAN0799](#)) by visiting our website.

Network status, node ID, errors, and baud rate in the controller system menu are all in reference to the CsCAN network. These indications can provide performance feedback on the CsCAN network and can also be used to aid in troubleshooting. Refer to the "System Settings" on page 24 chapter for full details.

CsCAN Network Troubleshooting Checklist

1. Use the proper Belden wire type or equivalent for the network as specified in [MAN0799](#).
2. The XLE/XLT does not provide 24VDC to the network. An external voltage source must be used for other devices such as SmartStix I/O.
3. Check voltage at both ends of the network to ensure that voltage meets specifications of attached devices.
4. Proper termination is required. Use 121 Ω (or 120 Ω) resistors at each end of the network. The resistors should be placed across the CAN_HI and CAN_LO terminals.
5. Measure the resistance between CAN_HI and CAN_LO. If the network is properly wired and terminated there should be around 60 Ω .
6. Check for duplicate node ID's.
7. Keep proper wires together. One twisted pair is for V+ and V- and the other twisted pair is used for CAN_HI and CAN_LO.
8. Make sure the baud rate is the same for all controllers on the network.
9. Assure shields are connected at one end of each segment -- they are not continuous through the network.
10. Do not exceed the maximum length determined by the baud rate and cable type.
11. Total drop length for each drop should not exceed 6m (20'). A drop may include more than one node. The drop length adds to the overall network length.
12. Network should be wired in "straight line" fashion, not in a "star" pattern.
13. In applications requiring multiple power supplies, make sure the V- of all supplies is connected and to earth ground at one place only.
14. In some electrically noisy environments it may be necessary to add repeaters to the network. Repeaters can be used to add additional nodes and/or distance to the network and protect the signal against noisy environments.

Removable Media Troubleshooting

RM Troubleshooting	
Description	Action
XLE/XLT does not read media card.	The media card should be formatted with the XLE/XLT.
XLE/XLT will not download project file.	Make sure the project file is saved as a .pgm file and not a .csp file.

Technical Support Contacts

For manual updates and assistance, contact Technical Support at the following locations:

North America:

Tel: (317) 916-4274

Fax: (317) 639-4279

Website: <https://hornerautomation.com>

Email: techsppt@heapg.com

Europe:

Tel: (+) 353-21-4321-266

Fax: (+353)-21-4321826

Website: <https://www.hornerautomation.eu>

Email: technical.support@horner-apg.com

INDEX



A

Alarms 132
 Analog Inputs 78
 Analog Outputs 87
 Auto firmware update via %SR's 168
 AutoLoad 153
 Automatic Restore 152
 AutoRun 155

B

Background 57
 Backup Battery 162
 Steps 163
 Backup OCS Data 150

C

CAN Communications 110
 Cscape Programming 111
 CAN Connector 110
 CAN Termination 111
 Capture Screens 139
 Clear Backup Data 151
 Clone Unit 41, 143
 Load Clone 146
 Communicating via MJ1 Serial Port 63
 Communicating via On Board Ethernet Port 64
 Connecting to the XLE/XLT 170
 Contrast 28
 CsCAN Network Troubleshooting 172
 Cscape Configuraiton
 Background 57
 Establishing Communications 59
 Cscape Configuration 57, 65
 via On Board Ethernet Port 64
 Cscape Programming
 via Serial Port 63
 Cscape Programming via CAN 111
 Cscape Programming via Serial Port 108
 Cscape Status Bar 58

D

Device List and Device Configuration 123
 Digital / HSC Input Configuration 69
 Digital / PWM Output Configuration 73
 Dip Switches 107
 Download Firmware 166
 Duty Cycle Count 97

E

Editable Screen Objects 131

Electrical Installation 21
 Ground Specifications 21
 How to Test for Good Ground 21
 Primary Power Port 22
 Establishing Communications 59
 Ethernet Communication 113
 Ethernet Configuration - IP Parameters 117
 Ethernet Module Configuration 114
 Ethernet Module Protocol Configuration 117
 Ethernet Module Protocols and Features 113
 Ethernet System Requirements 113
 Examples
 PWM 96
 Scaling Analog Inputs 86
 STP 103

F

Factors Affecting Panel Layout Design and Clear-
 ances 18
 Fail-Safe
 AutoLoad 153
 Automatic Restore 152
 AutoRun 155
 Backup 150
 Backup and Restore 150
 Clear Backup Data 151
 Restore 151
 Settings 150
 Fail-Safe Features 149
 Fail-Safe System 149
 FCC Compliance 8
 Features of the XLE/XLT 13
 Filenames and Function Blocks 141
 Firmware Update 165
 Auto 168
 Download Files 166
 Manual Update 168
 Firmware Update Details 165
 Firmware Update via microSD card 167
 Firmware Updates
 Steps 166
 Format a microSD Card 136
 Frequency 89

G

General I/O
 Analog Input 78
 Analog Output 87
 Digital Input 69
 Digital Output 73
 HSC 69

PWM 73
Relay Outputs 74
Scaling Analog Inputs 86
Solid State 73
General I/O Configuration 67
Graphic/Screen Editor 140
Ground Specifications 21
Grounding 19

H

High-Speed I/O
Accumulator 100
Duty Cycle Count 97
Frequency 89
Period Count 97
Pulse 91
Stepper 101
Sync Pulse Table 94
High-Speed I/O
Totalize 90
High-Speed IO
HSC Output 99
Period Measurement 91
PWM Functions 95
Quadrature 92
Register Map 94
High Speed Counter (HSC) Functions 89
High Speed I/O 89
High Speed Output Functions
STP Examples 103
How to Test for Good Ground 21
HSC Input Configuration 69
HSC Output 99
HSC Register Map for XLE & XLT 94

I

I/O Register Map for XLE/XLT 54
Install & Remove a microSD card 137
Installation 18
Introduction 11
Connectivity 12
Datasheets 12
Features of XLE-XLT 13

L

Ladder-Controlled Serial Communication 108
Ladder Based Screen Navigation 131
LED Lights 24
Load and Save Applications 138
Load Clone 146
Local I/O Troubleshooting 171

Log Data 138

M

Manual Firmware Update via %SR's 168
Mechanical Installation 15
Mounting 15
Panel Cutout 17
Panel Layout 18
Procedure 18
microSD Cards 136
Modbus Addressing Tables 159
Modbus Communications 157
Modbus Master 158
Modbus Slave 157
Mounting Orientation 16
Mounting Procedures 15
Mounting Procedures (Installed on DIN Rail) 16

N

Network Baud Rate 28
Network Configuration 121
Network ID 28
Network Protocols 122
Noise 19

P

Panel Cutout 17
Panel Layout Design and Clearance Checklist 19
Period Count 97
Period Measurement 91
Precautions & Safety 162
Primary Power Port 22
Program Features 140
Protocol Configuration 119
Data Mapping 127
Device Configuration 124
Device Driver 120
Device List 123
Network Configuration 121
Network Protocols 122
Scan List 125
Protocol Device Driver Selection 120
Pulse 91
Pulse Width Modulation (PWM) Functions 95
PWM Examples 96
PWM Functions Register Map 96
PWM Old and New Registers 98
PWM Output Configuration 73
PWM Output Waveform Table 98
PWM Wave Output Form 98

	Q	
Quadrature		Shock and Vibration 19
		Solid State Digital Outputs 73
	R	Stepper Function 101
Registers		Stepper Parameters 101
HSC 94		Steps for Battery Replacement 163
I/O Map 54		STP Examples 103
PWM 96		Sync Pulse Mode Table 94
Relay Outputs 74		System Menu 24
Removable Media 136		System Registers
Load and Save 138		%S Registers 46
Log Data 138		System Registers used with RM 141
RM Function Blocks 139		System Settings 24
RM Manager 138		Fail-Safe System 39
Screen Capture 139		LED Lights 24
System Registers 141		Removable Media 35
Removable Media (RM) Function Blocks in		RM Function Keys 36
Cscope 139		Touch Screen Calibration 43
Removable Media Manager 138		System Registers 45
Removable Media Troubleshooting 173		%SR Registers 47
Removing the Back Cover 68		Definitions 45
Resource Limits 55		Sytem Settings
Restore OCS Data 151		Clone Unit 41
RS-485 Biasing 108		
RS-485 Termination 108		T
	S	
safety and Compliance		Technical Support 173
Safety Precautions 9		Technical Support Contacts 173
Safety and Compliance 8		Temperature / Ventilation 19
FCC Compliance 8		The Accumulator 100
Warnings 8		Time/Date 34
Safety Precautions 9		Totalize 90
Scaling Analog Inputs & Examples 86		Troubleshooting 170
Scan List 125		Connecting to OCS 170
Screen Brightness 134		RM 173
Screen Navigation 130		Technical Support 173
Screen Saver 134		Troubleshooting Checklist 171
Serial Communicationis		
RS-485 Biasing 108		U
Serial Communications 105		
Dip Switches 107		Update Firmware Steps 166
Ladder-Controlled 108		User Interface 130
Port Descriptions 105		
Port Wiring 106		V
Programming 108		
RS-485 Termination 108		View and Capture Screens 139
Serial Ports 33		View Diags 30
Set Beeper 34		View I/O Slots 31
Set Keys 33		View Protocols 32
Set Serial Ports 33		View Status 29
		Visual Overview 11
		X
		XLE/XLEe System Menu Map 26
		XLT/XLTe System Menu 27

Change Log

Change Log			
Date	Rev #	Description of Revision with Mantis #	Location in Doc
3-18-2021	12	#2801 – How to Format microSD card #2831 – Add Change Log #3343 – microSD v. Flash Memory #3467 – 121 ohm resistor #4567 – EMI definition	Format a microSD card Change Log RM Overview CAN Termination Fail-Safe System
8-5-2021	13	#4845 – Updated WebMI register #4802 – WebMI – Max # of connections #4964 – Stepper Function Limitation #5381 – Load FW via microSD card	SR Table Ethernet Overview Stepper Function Firmware Update
5/12/22	13.2	#7591 – LED Info #7622 – Screen Calibration	LED Info Screen Calibration
7/22/22	13.3	#7635 – Pulse Output info	HSC Output
12/12/22	20	#8470 - Convert to Madcap Flare Output	Throughout
1/24/23	21	#9514 - Adding missing Resource tables	System Register Chapter