

RCC1410 DATASHEET

14 Digital Inputs, 10 Digital Outputs



1 TECHNICAL SPECIFICATIONS

1.1 General

Required Pwr. (steady state)	120mA at 24VDC
Required Pwr. (inrush)	25A for 1 ms at 24VDC switched
Primary Pwr. Range	10-32VDC
Real-Time Clock	Yes
Clock Accuracy	+/- 8 seconds/month at 25°C
Relative Humidity	5-95% non-condensing
Operating Temp.	-10°C to +60°C
Storage Temp.	-10°C to +60°C
Battery	Li-Ion Polymer Battery Charging Range 0-50°C
Weight	10 oz / 283.5 g
Mounting	35 mm DIN Rail or Panel Surface
Housing Type	Plastic (UL 50 rated, flame retardant, UV resistant)
Certifications (CE)	USA: https://hornerautomation.com/certifications/ Europe: http://www.horner-apg.com/en/support/certification.aspx

1.2 Control & Logic

Control Lang. Support	Advanced Ladder Logic Full IEC 61131-3 Languages
Logic Size & Scan Rate	128kB, 0.013ms/kB
Online Programming Changes	Supported in Advanced Ladder
PID Support	Up to 6
Digital Inputs (%I)	2048
Digital Outputs (%Q)	2048
Analog Inputs (%AI)	512
Analog Outputs (%AQ)	512
Gen. Purpose 16-bit Registers (%R)	4096 Retentive
Gen. Purpose 1-bit Registers (%T)	2048 Non-Retentive
Gen. Purpose 1-bit Registers (%M)	2048 Retentive

1.3 Digital DC Inputs

Inputs per Module	14	
Commons per Module	1	
Addressing	%I1 - %I14	
Input Voltage Range	0-30VDC	
Absolute Max. Voltage	35VDC Max.	
Input Impedance	10kΩ	
Input Current	Pos. Logic	Neg. Logic
Min. "On" Current	0.8mA	-1.6mA
Max. "Off" Current	0.3mA	-2.1mA
Min. "On" Input	8VDC	
Max. "Off" Input	3VDC	
OFF to ON Response	100μs min*	
ON to OFF Response	100μs min*	
Galvanic Isolation	None	
Logic Polarity	Pos. or Neg. Based on configuration	
I/O Indication	LED	
High Speed Counter (HSC)	None	
Connector Type	5.08mm & 3.5mm Pluggable Cage Clamp	

1.4 Connectivity

Serial	2 (1xRS232, 1x2-wire RS485)
CAN	1 x 125kbps - 1Mbps
Ethernet	1 x 10Mbps/100Mbps
microSD	1 x SD, SDHC, SDXC in FAT32 format
USB	No
Communication Support	WebMI
	Web Portal
	Outgoing Email with Attachments
	TCP/IP and Modbus TCP/IP
	FTP
	Data Logging

1.5 Digital DC Outputs

Outputs per Module	10
Commons per Module	1
Addressing	%Q1 - %Q10
Output Type	Sourcing
Absolute Max. Voltage	30VDC Max.
Output Protection	Short Circuit & Overvoltage
Max. Output Current per Point	0.5A
Max. Total Current	2A Total Current
Max. Output Supply	30VDC
Min. Output Supply	10VDC
Max. Voltage Drop at Rated Current	0.25VDC
Min. Load	None
I/O Indication	LED
Galvanic Isolation	None
OFF to ON Response	500ns min*
ON to OFF Response	500ns min*
PWM Out	None
Output Characteristics	Current Sourcing (Pos. Logic)

RCC Series User Manual [MAN1078]

The User Manual includes extensive information on:

- Installation
- Communications
- Configuration
- Resource Limits

* all values updated 1x per scan

2 CONTROLLER OVERVIEW

2.1 - Port Connectors

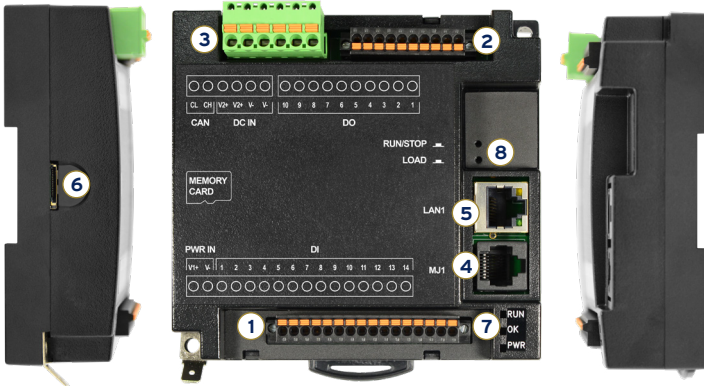

- | | | | |
|----------------------------|------------------------------|------------------|----------------|
| 1. Power & Input Connector | 3. CAN Port & External Power | 5. Ethernet Port | 7. Status LEDs |
| 2. Output Connector | 4. Serial Port | 6. microSD Slot | 8. Buttons |

2.2 - Power Wiring

To power up the RCC1410, supply 10-32VDC to the V+ and C connections on the Power & Input connector.

3 WIRING: INPUTS & OUTPUTS

3.1 - Digital Input Wiring

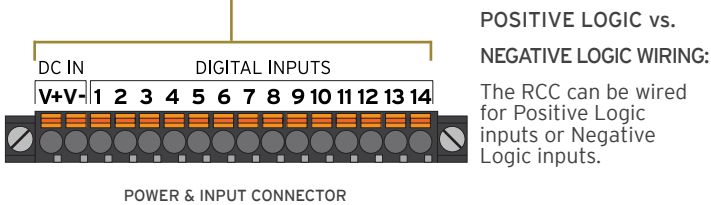
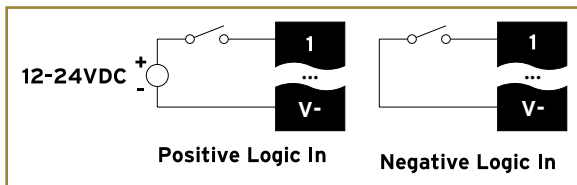

Digital inputs may be wired in either a Positive Logic or Negative Logic fashion as shown. The setting in the Cscape Hardware Configuration for the Digital Inputs must match the wiring used in order for the correct input states to be registered. The state of the input is reflected in registers %I1 - %I8.

wiring: I/O continued...

3.2 - Digital Output Wiring

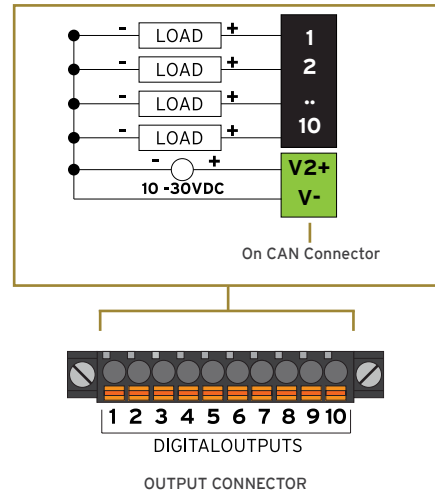

Digital outputs are Positive Logic. If an output is turned on, the voltage supplied at the Vext terminal is applied to that output. When used as normal inputs, the state of the output may be controlled using the registers %Q1, %Q2, %Q3, %Q4.

4 COMMUNICATIONS

4.1 - CAN Communications

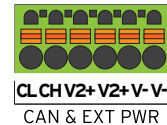

The CAN port is provided via three connections on the CAN & Ethernet Power connector: CAN_LOW (CL), CAN_HIGH (CH), and V- (C). It may be used to communicate with the other OCS products using Horner's CsCAN protocol. Additionally, remote expansion I/O, such as SmartRail, SmartBlock, and SmartStix may be implemented using the CsCAN protocol. If CsCAN expansion I/O is to be used, a 24VDC power source will be required on the CsCAN bus in order to power the expansion I/O modules. This connector also houses the connections for Digital Output source power.

4.2 - microSD Slot

A microSD card may be used for data and alarm logging, historic trending, program loading, firmware updates, and many other features. Supported types of MicroSD cards are SD, SDHC, and SDXC as long as the format of the card file system is FAT32.

Wiring Specifications

- **For I/O Wiring (discrete)**, use the following wire type or equivalent: Belden 9918, 18AWG (0.8mm²) or larger.
- **For CAN wiring**, use the following wire type or equivalent: Belden 3084, 24 AWG (0.2mm²) or larger.
- **Torque Rating:** 4.5-7 in-lbs (0.50 - 7.8N-m)
- **Power Up:** Connect to Earth Ground. Apply 10-30VDC

communications continued...

communications continued...

4.3 - Serial Communications

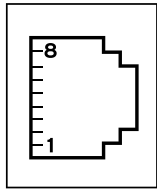

MJ1/2 SERIAL PORTS

MJ1: RS-232 w/full handshaking

MJ2: RS-485 half-duplex

Both serial ports are in one modular jack. To break pins out to terminals, use HE200MJ2TRM accessory

NOTE: Refer to connector pinout on product

Two serial ports are provided via the single 8-position modular jack labeled "MJ1/2". MJ1 defaults to one of several methods available to program the controller. It may instead be specified for RS-232 communications, such as for Modbus Master/Slave, or to communicate to devices such as bar code scanners.

MJ2 may only be used as half-duplex (2-wire) RS-485. The most common use is for Modbus communications, either as a Modbus Master or Modbus Slave, though other options are also available.

1.8 MJ1 PINS		MJ2 PINS		
PIN	SIGNAL	DIRECTION	SIGNAL	DIRECTION
8	TXD	OUT	-	-
7	RXD	IN	-	-
6	0 V	GROUND	0V	GROUND
5	+5V @ 60mA	OUT	+5V @ 60mA	OUT
4	RTS	OUT	-	-
3	CTS	IN	-	-
2	-	-	RX-/TX-	IN/OUT
1	-	-	RX+/TX+	IN/OUT

4.4 - Ethernet Communications

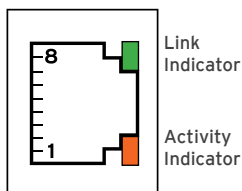

A 10/100 Ethernet port with automatic MDI-X (crossover detection) is provided via the single 8-position modular jack labeled "LAN". Several features are available for use over Ethernet, such as WebMI, Modbus TCP/IP, Ethernet/IP, SMTP (E-mail), expansion I/O to SmartRail, and more. Ethernet configuration is done via the Cscape Hardware Configuration. For more information on Ethernet, available features and protocols, refer to the Ethernet Supplement document (SUP0740).

4.5 - Status LEDs

Three LEDs provide general status of the RCC:

LED - Normal Functionality			
LED TYPE	WHEN OFF	WHEN ON	WHEN FLASHING (1Hz)
PWR	No power applied	10-30VDC applied	N/A
OK	Self-test fail	Self-test pass	I/O forcing enabled
RUN	Stop mode	Run mode	Do I/O Mode



LED - DIAGNOSTIC FUNCTIONALITY

When the OK and RUN are flashing alternately, a download is in progress. When the flashing stops, the download is complete and the unit reboots (allow 30 seconds). When flashing together, the download has failed, and the number of flashes indicates the error. There will be a two second gap and the pattern will be repeated. The number of flashes and the associated error are as follows:

- **2 Flashes** - The MAC ID is empty.
- **3 Flashes** - The internal MAC file is corrupt.
- **4 Flashes** - The MAC ID TXT file is invalid.
- **5 Flashes** - The MAC ID file is not found or the microSD card is empty or missing system files.

4.6 - Buttons

Two recessed buttons provide control of several RCC modes. A paperclip may be used as the buttons are far enough recessed that a pen or pencil is not able to activate them.



LOAD SWITCH

- Pressing the LOAD switch during power-up boots from the microSD card. This starts a Firmware Load if the microSD is bootable and valid firmware files are found on it.
- After boot-up, pressing the LOAD switch for three (3) seconds will load an Application file stored on the microSD. The application file name must be DEFAULT.PGM. When loading an application file from microSD, there should not be firmware files present on the microSD card.

RUN/STOP SWITCH

- After boot-up, pressing the RUN/STOP switch for 3 seconds toggles the RCC between RUN and STOP modes.

ERASE PROGRAM FUNCTION

- After boot-up, pressing both Load and RUN/Stop switches for 3 seconds performs an "Erase All" function, which deletes all application programs.

communications continued on next page...

5 BATTERY

5.1 - Battery Maintenance

The RCC1410 has an advanced battery system that uses a rechargeable lithium battery. The battery powers the real time clock when power is removed, and it is needed for register data retention. Please reference the RCC Series User Manual [MAN1078] which provides instructions on how to replace the battery.

NOTE: For detailed rechargeable battery information, refer to the Battery Manual [MAN1142].

6 DIMENSIONS

6.1 - Dimensions & Panel Cutout

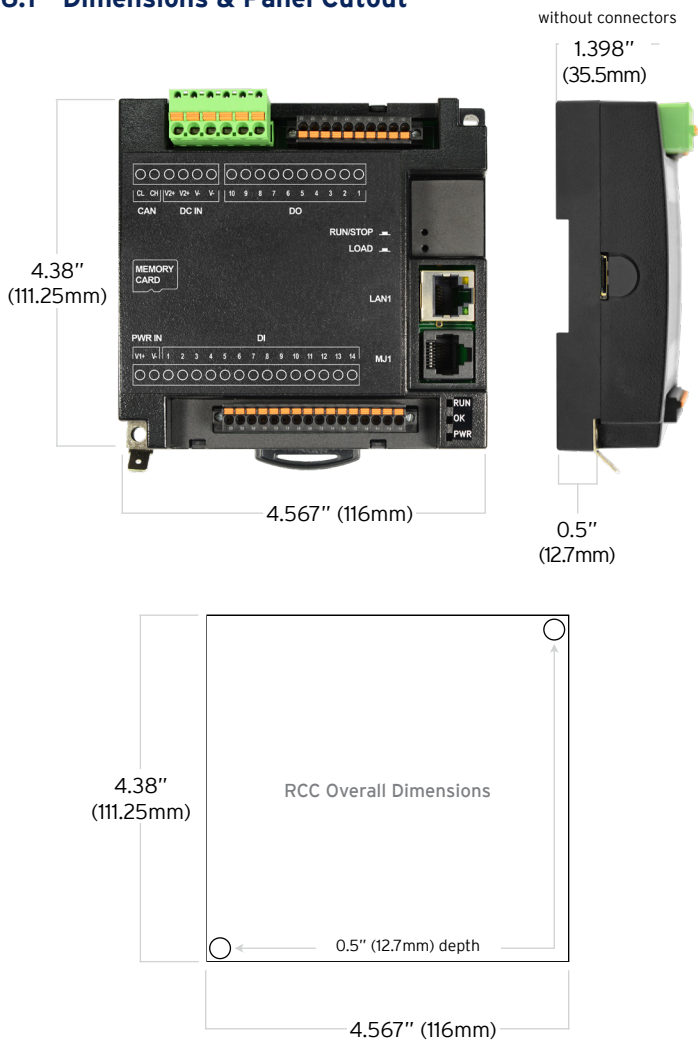

7 PART NUMBER

7.1- Global Part Number

The global part number is **HE-RCC1410**.

8 BUILT-IN I/O

8.1 - I/O Functions for RCC1410

Digital I/O Functions	
Registers	Description
%I1 to %I8	Digital Inputs
%I9 to %I15	Reserved
%I16	%Q Fault Status
%Q1 to %Q4	Digital Outputs

9 SAFETY

9.1 - WARNINGS

- To avoid the risk of electric shock or burns, always connect the safety (or earth) ground before making any other connections.
- To reduce the risk of fire, electrical shock, or physical injury, it is strongly recommended to fuse the voltage measurement inputs. Be sure to locate fuses as close to the source as possible.
- Replace fuse with the same type and rating to provide protection against risk of fire and shock hazards.
- In the event of repeated failure, do NOT replace the fuse again as repeated failure indicates a defective condition that will NOT clear by replacing the fuse.
- Only qualified electrical personnel familiar with the construction and operation of this equipment and the hazards involved should install, adjust, operate, or service this equipment. Read and understand this manual and other applicable manuals in their entirety before proceeding. Failure to observe this precaution could result in severe bodily injury or loss of life.

9.2 - FCC COMPLIANCE

This device complies with part 15 of the FCC Rules. Operation is subject to the following two conditions:

- This device may not cause harmful interference
- This device must accept any interference received, including interference that may cause undesired operation

9.3 - PRECAUTIONS

All applicable codes and standards need to be followed in the installation of this product. Adhere to the following safety precautions whenever any type of connection is made to the module:

- Connect the safety (earth) ground on the power connector first before making any other connections.
- When connecting to the electric circuits or pulse-initiating equipment, open their related breakers.
- Do NOT make connection to live power lines.
- Make connections to the module first; then connect to the circuit to be monitored.
- Route power wires in a safe manner in accordance with good practice and local codes.
- Wear proper personal protective equipment including safety glasses and insulated gloves when making connections to power circuits.
- Ensure hands, shoes, and floor are dry before making any connection to a power line.
- Make sure the unit is turned OFF before making connection to terminals.
- Make sure all circuits are de-energized before making connections.
- Before each use, inspect all cables for breaks or cracks in the insulation. Replace immediately if defective.
- Use copper conductors in Field Wiring only, 60/75°C.

10 TECHNICAL SUPPORT

10.1- Contact Information

For assistance and manual updates, contact Technical Support at the following locations:

North America

+1 (317) 916-4274
 (877) 665-5666
www.hornerautomation.com
techsppt@heapg.com

Europe

+353 (21) 4321-266
www.horner-apg.com
technical.support@horner-apg.com