

MODEL 2:

12 DC In, 6 Relay Out, 4 - 12-bit Analog IN

J1 (Orange) Name	
I1	IN1
I2	IN2
I3	IN3
I4	IN4
I5	IN5
I6	IN6
I7	IN7
I8	IN8
H1	HSC1 / IN9
O1	Common
A1	Analog IN1
A2	Analog IN2
A3	Analog IN3
A4	Analog IN4
O1	Common

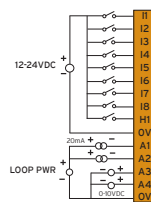

J2 (Black) Name	
C6	Relay 6 COM
R6	Relay 6 NO
C5	Relay 5 COM
R5	Relay 5 NO
C4	Relay 4 COM
R4	Relay 4 NO
C3	Relay 3 COM
R3	Relay 3 NO
C2	Relay 2 COM
R2	Relay 2 NO
C1	Relay 1 COM
R1	Relay 1 NO
H4	HSC4 / IN12
H3	HSC3 / IN11
H2	HSC2 / IN10

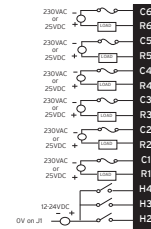

MODEL 3:

12 DC In, 12 DC Out, 2 - 12-bit Analog IN

J1 (Orange) Name	
I1	IN1
I2	IN2
I3	IN3
I4	IN4
I5	IN5
I6	IN6
I7	IN7
I8	IN8
H1	HSC1 / IN9
H2	HSC2 / IN10
H3	HSC3 / IN11
H4	HSC4 / IN12
A1	Analog IN1
A2	Analog IN2
O1	Common

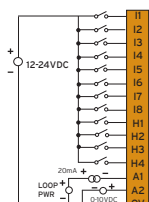

J2 (Black) Name	
O1	Common
V+	V+
NC	No Connect
Q12	OUT 12
Q11	OUT 11
Q10	OUT 10
Q9	OUT 9
Q8	OUT 8
Q7	OUT 7
Q6	OUT 6
Q5	OUT 5
Q4	OUT 4
Q3	OUT 3
Q2	OUT 2 / PWM2
Q1	OUT 1 / PWM1

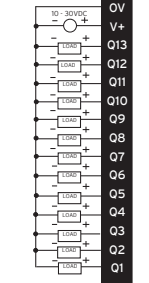

MODEL 4:

24 DC In, 16 DC Out, 2 - 12-bit Analog IN

J1 (Orange) Name	
I1	IN1
I2	IN2
I3	IN3
I4	IN4
I5	IN5
I6	IN6
I7	IN7
I8	IN8
H1	HSC1 / IN9
H2	HSC2 / IN10
H3	HSC3 / IN11
H4	HSC4 / IN12
A1	Analog IN1
A2	Analog IN2
O1	Common

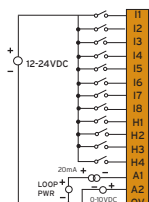

J3 (Orange) Name	
I13	IN13
I14	IN14
I15	IN15
I16	IN16
I17	IN17
I18	IN18
I19	IN19
I20	IN20
I21	IN21
I22	IN22
I23	IN23
I24	IN24
O1	Common

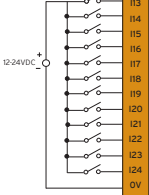

J2 (Black) Name	
O1	Common
V+	V+
NC	OUT 13
Q12	OUT 12
Q11	OUT 11
Q10	OUT 10
Q9	OUT 9
Q8	OUT 8
Q7	OUT 7
Q6	OUT 6
Q5	OUT 5
Q4	OUT 4
Q3	OUT 3
Q2	OUT 2 / PWM 2
Q1	OUT 1 / PWM 1

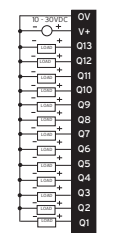

J4 (Orange) Name	
Q16	OUT16
Q15	OUT15
Q14	OUT14

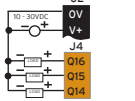

MODEL 5:

12 DC In, 12 DC Out, 2 - 14/16-bit Analog IN (mA/V/TC/mV/RTD), 2 - 12-bit Analog Out

J1 (Orange) Name	
I1	IN1
I2	IN2
I3	IN3
I4	IN4
I5	IN5
I6	IN6
I7	IN7
I8	IN8
H1	HSC1 / IN9
H2	HSC2 / IN10
H3	HSC3 / IN11
H4	HSC4 / IN12
NC	No Connect
NC	No Connect
O1	Common

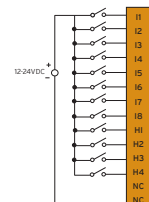

J3 (Orange) Name	
T1+	Tc (1+) or RTD (1+) or 100 mV (1+)
T1-	Tc (1-) or RTD (1-) or 100 mV (1-)
T2+	Tc (2+) or RTD (2+) or 100 mV (2+)
T2-	Tc (2-) or RTD (2-) or 100 mV (2-)
AQ1	10 V or 20 mA OUT (1)
AQ2	10 V or 20 mA OUT (2)
O1	Common
MA1	0-20 mA IN (1)
V1	0-10 V IN (1)
O1	Common
MA2	0-20 mA IN (2)
V2	0-10 V IN (2)
O1	Common

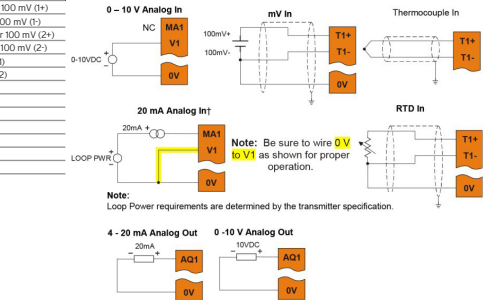

J2 (Black) Name	
O1	Common
V+	Output Power
NC	No Connect
Q12	OUT12
Q11	OUT11
Q10	OUT10
Q9	OUT9
Q8	OUT8
Q7	OUT7
Q6	OUT6
Q5	OUT5
Q4	OUT4
Q3	OUT3
Q2	OUT2 / PWM2
Q1	OUT1 / PWM1

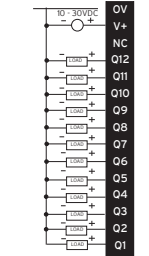

MODEL 6:

12 DC In, 12 DC Out, 6 - 17-bit Analog IN (mA/V/TC/mV/RTD), 4 - 12-bit Analog Out

J1 (Orange/Green) Name	
I1	IN1
I2	IN2
I3	IN3
I4	IN4
I5	IN5
I6	IN6
I7	IN7
I8	IN8
H1	HSC1 / V IN9
H2	HSC2 / V IN10
H3	HSC3 / V IN11
H4	HSC4 / V IN12
O1	Common
A1A	Univ. AI 1 Pin 1
A1B	Univ. AI 1 Pin 2
A1C	Univ. AI 1 Pin 3
NC	No Connect
A2A	Univ. AI 2 Pin 1
A2B	Univ. AI 2 Pin 2
A2C	Univ. AI 2 Pin 3
NC	No Connect

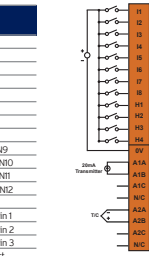

J3 (Orange/Green) Name	
NC	No Connection
A3A	Univ. AI 3 Pin 1
A3B	Univ. AI 3 Pin 2
A3C	Univ. AI 3 Pin 3
NC	No Connection
A4A	Univ. AI 4 Pin 1
A4B	Univ. AI 4 Pin 2
A4C	Univ. AI 4 Pin 3
NC	No Connection
A5A	Univ. AI 5 Pin 1
A5B	Univ. AI 5 Pin 2
A5C	Univ. AI 5 Pin 3
NC	No Connection
A6A	Univ. AI 6 Pin 1
A6B	Univ. AI 6 Pin 2
A6C	Univ. AI 6 Pin 3
O1	Common
V4	V OUT 4*

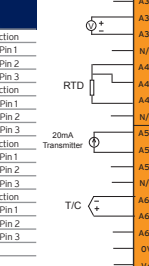

J2 (Black/Green) Name	
V3	V OUT 3*
V2	V OUT 2*
V1	V OUT 1*
mA4	mA OUT 4*
mA3	mA OUT 3*
mA2	mA OUT 2*
mA1	mA OUT 1*
Q1	OUT 1 / PWM1
Q2	OUT 1 / PWM2
Q3	OUT 3
Q4	OUT 4
Q5	OUT 5
Q6	OUT 6
Q7	OUT 7
Q8	OUT 8
Q9	OUT 9
Q10	OUT 10
Q11	OUT 11
Q12	OUT 12
V+	V External+
O1	Common

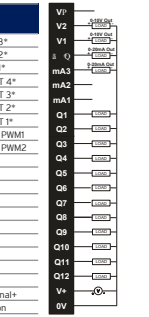

NOTE: * Both mA & V outputs are active for each output channel, however, only the configured output type is calibrated (maximum 4 channels simultaneously).

ALL MODELS:

Power Wiring Connector
Primary Power Range: 10-30VDC

PIN	SIGNAL	DESCRIPTION
1	Ground	Frame Ground
2	DC-	Power Supply Common
3	DC+	Power Supply Voltage



Precautions

All applicable codes and standards need to be followed in the installation of this product. Adhere to the following safety precautions whenever any type of connection is made to the module:

1. Connect the safety (earth) ground on the power connector first before making any other connections.
2. When connecting to the electric circuits or pulse-initiating equipment, open their related breakers.
3. Do NOT make connection to live power lines.
4. Make connections to the module first; then connect to the circuit to be monitored.
5. Route power wires in a safe manner in accordance with good practice and local codes.
6. Wear proper personal protective equipment including safety glasses and insulated gloves when making connections to power circuits.
7. Ensure hands, shoes, and floor are dry before making any connection to a power line.
8. Make sure the unit is turned OFF before making connection to terminals.
9. Make sure all circuits are de-energized before making connections.
10. Before each use, inspect all cables for breaks or cracks in the insulation. Replace immediately if defective.
11. Use copper conductors in Field Wiring only, 60/75° C.
12. Do not disconnect while circuit is live unless area is known to be non-hazardous.
13. Do not remove or replace jumpers or connectors while circuit is live unless the area is known to be free of ignitable concentrations of flammable gases or vapors.
14. EXPLOSION HAZARD - substitution of components may impair suitability for Class I, Division 2.
15. Use caution when making connections to the controller to protect against static discharge. Special care must be taken when replacing the battery or inserting or adjusting I/O or communication boards.
16. Use caution when connecting controllers to PCs via serial or USB. PCs and especially laptops may use "floating power supplies" what are ungrounded. This could cause a voltage potential between the laptop and controller. Make sure the controller and laptop are grounded for maximum protection.
17. For protection of USB devices the part number HE-USBISO is available to purchase from our website or your local distributor.
18. Failure to follow these guidelines can damage the controller and/or controller.

Hazardous Location Notice

Power, input and output (I/O) wiring must be in accordance with Class 1, Division 2 wiring methods [Article 501-4(b) of the National Electrical Code, NFPA 70] for installations in the U.S. or as specified in Section 18-1J2 of the Canadian Electrical Code for installations within Canada and in accordance with the authority having jurisdiction.

1. THIS EQUIPMENT IS SUITABLE FOR USE IN CLASS I, DIVISION 2, GROUPS A B C D or NON-HAZARDOUS LOCATIONS ONLY.
2. WARNING - EXPLOSION HAZARD - SUBSTITUTION OF COMPONENTS MAY IMPAIR SUITABILITY FOR CLASS I, DIVISION 2.
AVERTISSEMENT - RISQUE D'EXPLOSION LA SUBSTITUTION DE COMPOSANTS PEUT RENDRE INACCEPTABLE POUR LES EMPLACEMENTS DE CLASSE I, DIVISION 2
3. WARNING - EXPLOSION HAZARD - DO NOT DISCONNECT EQUIPMENT UNLESS POWER HAS BEEN SWITCHED OFF OR THE AREA IS KNOWN TO BE NON-HAZARDOUS AND FREE OF IGNITABLE CONCENTRATIONS.
ATTENTION - RISQUE D'EXPLOSION - NE DECONNECTEZ PAS L'EQUIPEMENT A MOINS DE L'AVOIR MIS HORS TENSION OU QUE LA ZONE EST CONNUE NON-DANGEREUSE ET NE CONTIENT PAS DE CONCENTRATIONS INFLAMMABLES.

FCC Compliance

This device complies with part 15 of the FCC Rules. Operation is subject to the following two conditions:

1. This device may not cause harmful interference
2. This device must accept any interference received, including interference that may cause undesired operation

Technical Support

For further details, please refer to the Datasheets, MAN1112 - MAN1117. For assistance and manual updates, contact Technical Support at the following locations:

North America
+1 (317) 916-4274
www.hornerautomation.com
techsppt@heapg.com

Europe
+353 (21) 4321-266
www.horner-apg.com
technical.support@horner-apg.com

Port Connectors / Panel Cut-Out

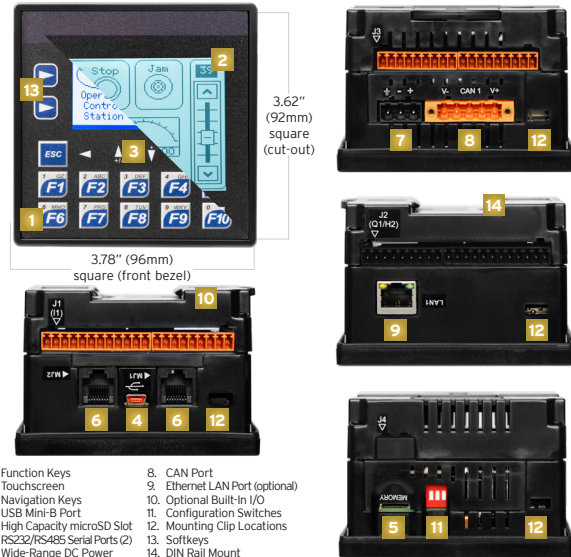

MAN1122-03-EN

XLE/XLT OCS CONTROLLERS

General Specifications

Model 0 Typical power-backlight 100%	136mA @ 10V (1.36W), 64mA @ 24V (1.53W)
Model 2 Typical power-backlight 100%	267mA @ 10V (2.67W), 121mA @ 24V (2.90W)
Model 3 Typical power-backlight 100%	164mA @ 10V (1.64W), 116mA @ 24V (2.77W)
Model 4 Typical power-backlight 100%	173mA @ 10V (1.73W), 132mA @ 24V (3.17W)
Model 5 Typical power-backlight 100%	339mA @ 10V (3.39W), 182mA @ 24V (4.36W)
Model 6 Typical power-backlight 100%	323mA @ 10V (3.23W), 150mA @ 24V (3.59W)
Power Backlight Off	-15mA @ 24V (0.36W)
Power Ethernet Models	+35mA @ 10V (0.35W); +20mA @ 24V (0.48W)
Inrush Current	30A for < 1mS
Primary Pwr. Range	10-30VDC
Real Time Clock	Battery backed; lithium coin cell CR2450
Clock Accuracy	+/- 90 Secs/Month
Relative Humidity	5 to 95% , Non-condensing
Operating Temp.	-10°C to +60°C
Storage Temp.	-20°C to +60°C
Weight	0.75 lbs/340g (without I/O)
Certifications (UL/CE)	USA: https://hornerautomation.com/certifications/ Europe: http://www.horner-apg.com/en/support/certification.aspx